

Via Monfalcone 41
20092 Cinisello Balsamo (Milano) – Italy
Tel. +39 0266013695 – Fax +39 0266013500

CODE NUMBER: 120000000902

SUBJECT: KCLP1457CR - Reflector for Power LEDs



Images shown above is Indicative only

- Fit for major COB LEDs
- Made in PCHT for special coating treatment
- Innovative vacuum coating treatment, specific for optical reflector systems
- High lighting efficiency over 85%
- Excellent luminous flux
- Innovative design
- Easy fixing onto the PCB by twist & lock block system
- Complying with UL94 Specifications
- Complying with Zhaga Standards



Typical Applications:

KCLP series is suitable for any application in Wide Area Lighting, Indoor and Outdoor:

- Industrial Lighting : Warehouses, Laboratories, Sheds, Garages, Machine Shops, etc.
- Indoor Lighting : Outlets & Shop Centers, Exhibition Areas, Offices, Hospital Wards, Passages, Aisles, etc.
- Outdoor Lighting : Parking Areas, Pathways, Petrol & Service Stations, Gardens, Playgrounds, Canopies, etc.
- Architectural Lighting : Entertainment & Decorative, Shop Windows, Halls & Entrances, Lamps , etc.

The Optical Reflector Systems from Khatod ensure the highest lighting efficiency thanks to our exclusive vacuum coating plant, specific for optical treatments .

The new reflectors from Khatod are provided with a special adaptor, customized for the major COB LEDs, allowing an immediate easy assembling of the reflector by a simple twist & lock block system.

The concept is very simple: first the adaptor is fixed onto the PCB while the reflector is then fixed by simply twisting and locking it onto the adaptor.

The Optical Reflector Systems from Khatod assure the highest in design and the easiest in usability, and guarantee the most efficient and cost-effective optical solution

Contents

1	Light Source Model	3
2	Measurement Setup	3
3	Results	3
4	Intensity Plot	4
5	Illuminance Map	5
6	Isolux / Isocandela Plots	6
7	Illuminance Diagram	7
8	Drawing	8
9	Use and Maintenance	9

1 Light Source Model

Parameter	Symbol	Value	Unit
Lens / Reflector Model	-	KCLP1457CR	-
Material (More info on page 9)	-	PC, ALUMINIUM	-
Dimensions	-	See page 8	-
Source Model	-	LUXEON S	-
Number of Sources	N	1	-
Power Supply Type	-	ISO TECH ISP3303	-
Driver Type	-	-	-
Driving Voltage	V_F	-	V
Driving Current	I_F	-	mA
Nominal Flux	Φ	1300×1	lm

2 Measurement Setup

Parameter	Symbol	Value	Unit
Operator	-	Simone Bassi	-
Goniophotometer Type	-	KLX12M	-
Measurement Distance	z	5	m
Room Temperature	T	25	°C
Date	-	23-Apr-2012	-

3 Results

Parameter	Symbol	Value	Unit
Total Flux	Φ	1300	lm
Max Intensity	I_{\max}	4673	cd
Max Illuminance at 5 m	E_{\max}	187	lx
C-Viewing Angle at 50% I_{\max}	$2\varphi_C$	19	°
γ -Viewing Angle at 50% I_{\max}	$2\varphi_\gamma$	20	°
C-Viewing Angle at 10% I_{\max}	$2\varphi_{C10\%}$	36	°
γ -Viewing Angle at 10% I_{\max}	$2\varphi_{\gamma10\%}$	38	°
General Optical Measurement Tolerance	-	±10%	-

NOTES:

- Intensity (I) and illuminance (E) data are normalized by 1000 lm
- The optical values shown are the result of optical simulations carried out with ASAP and ZEMAX software systems. The optical simulations are carried out on the basis of the typical values provided in the LED manufacturers' official datasheets. The photometric analysis has been carried out on physical samples. On request, by supplying your PCB, we can provide the measurement photometric file.

4 Intensity Plot

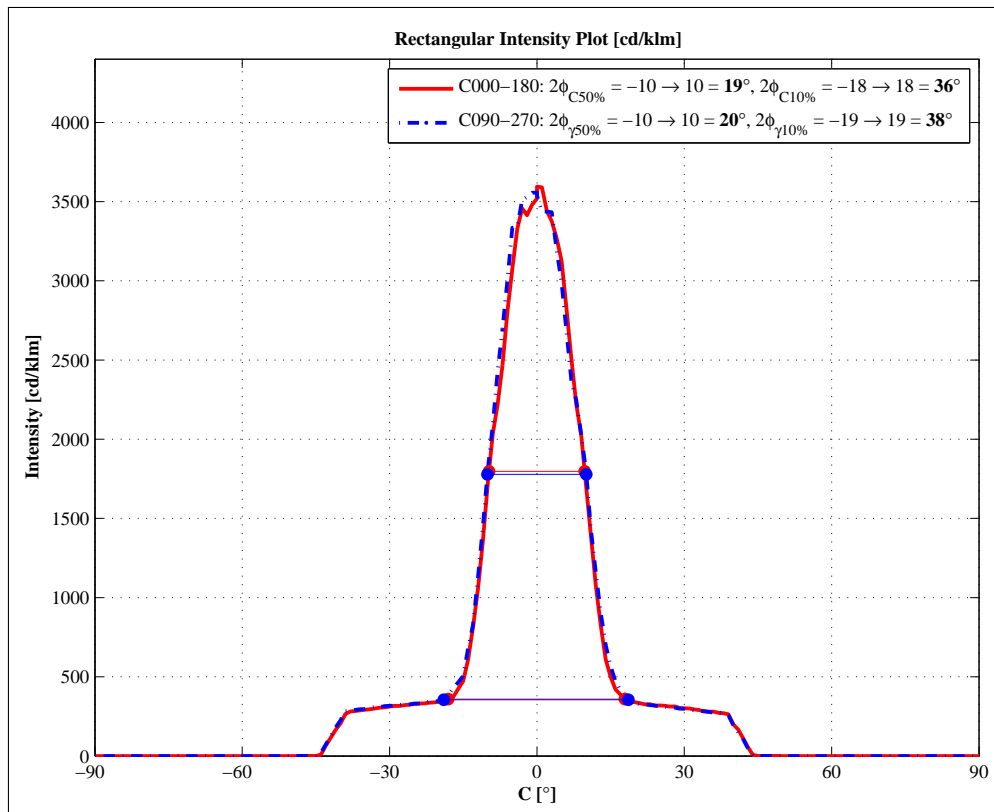
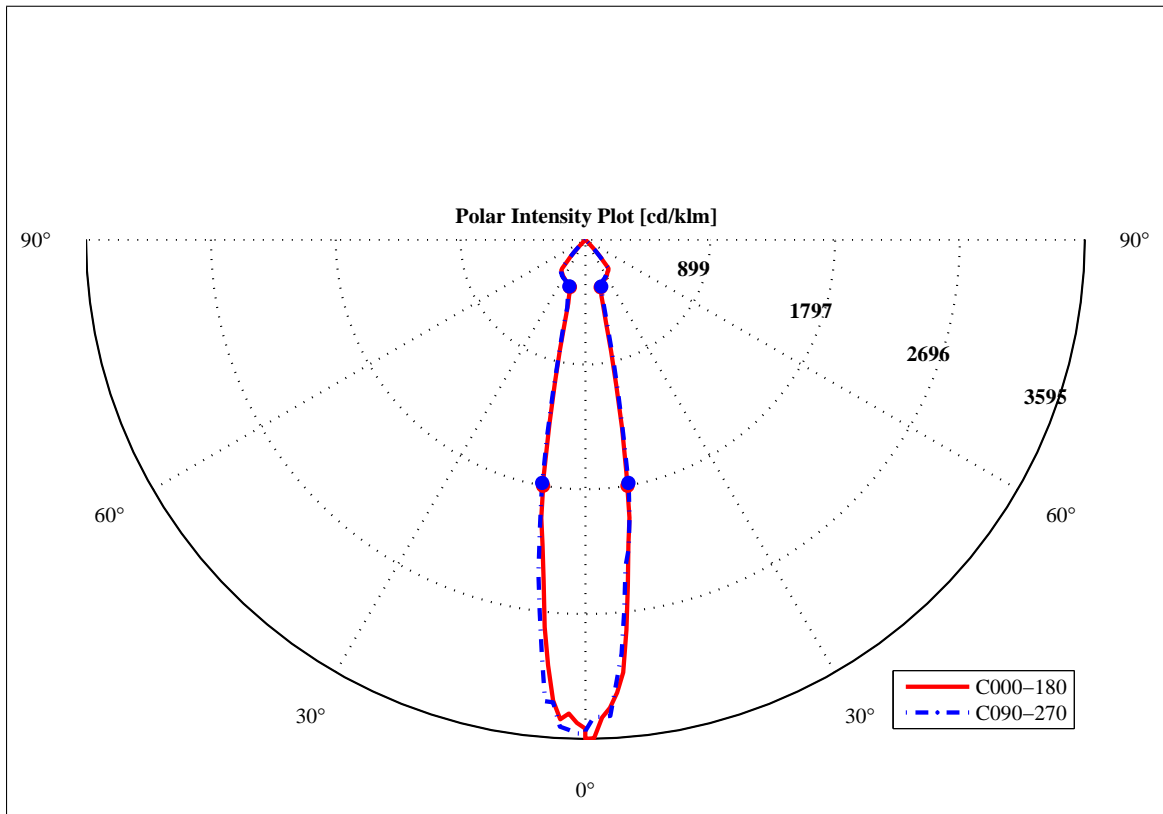

5 Illuminance Map

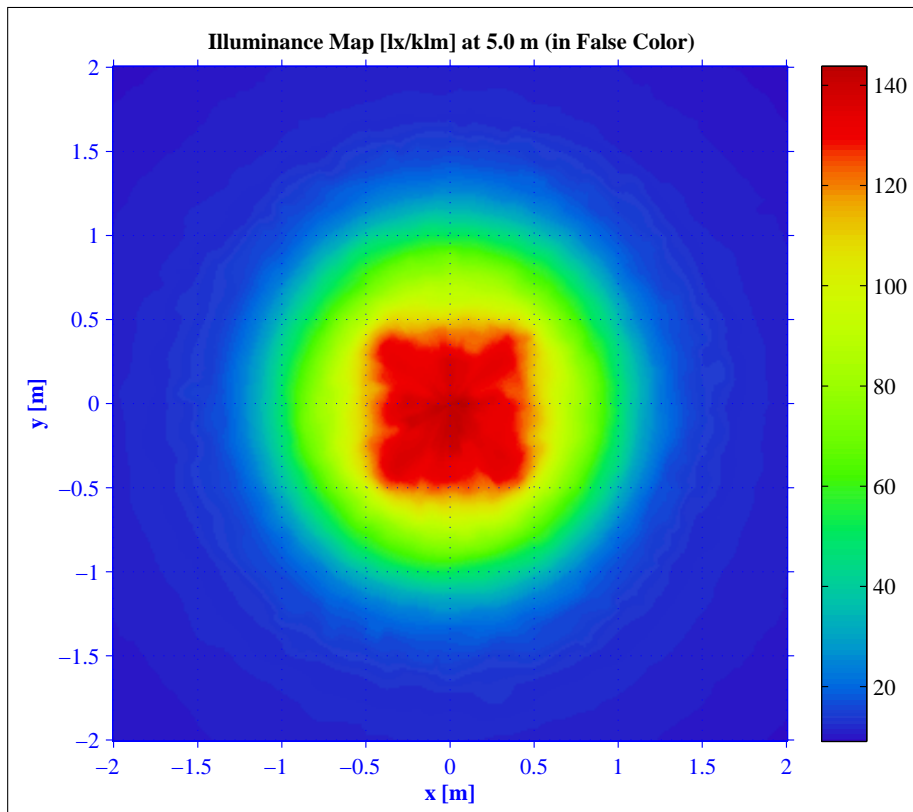
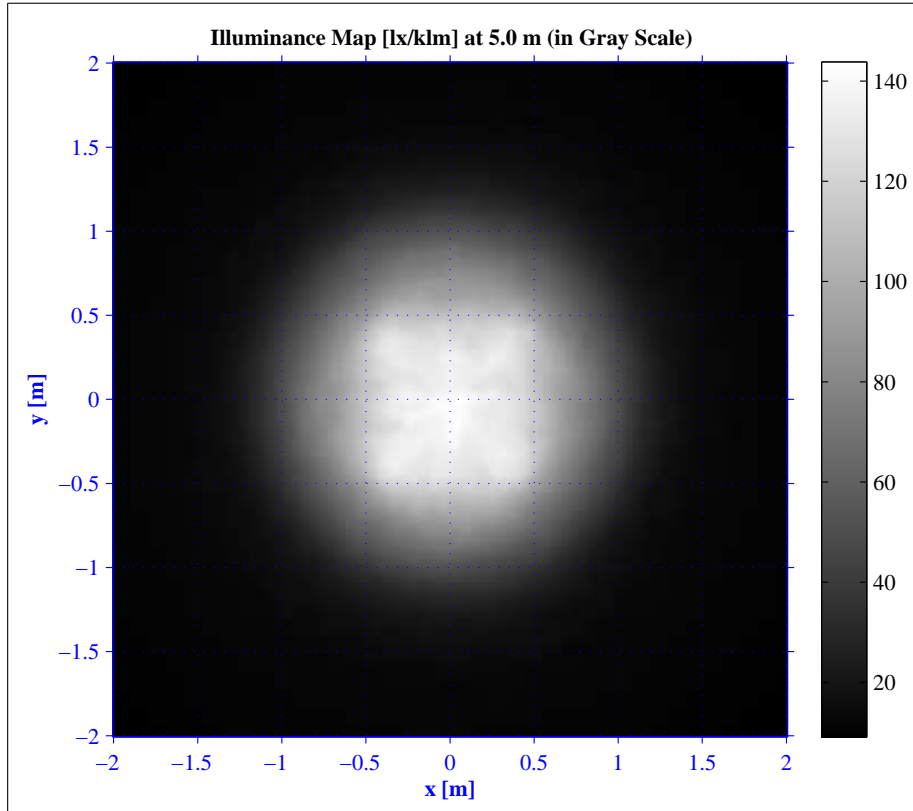

6 Isolux / Isocandela Plots

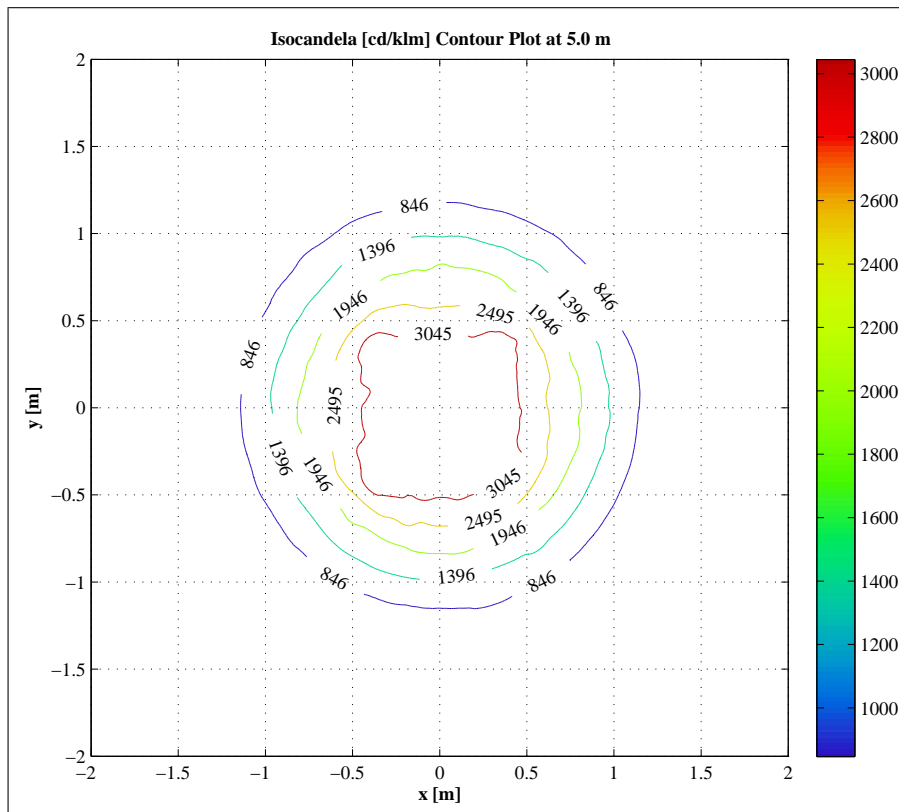
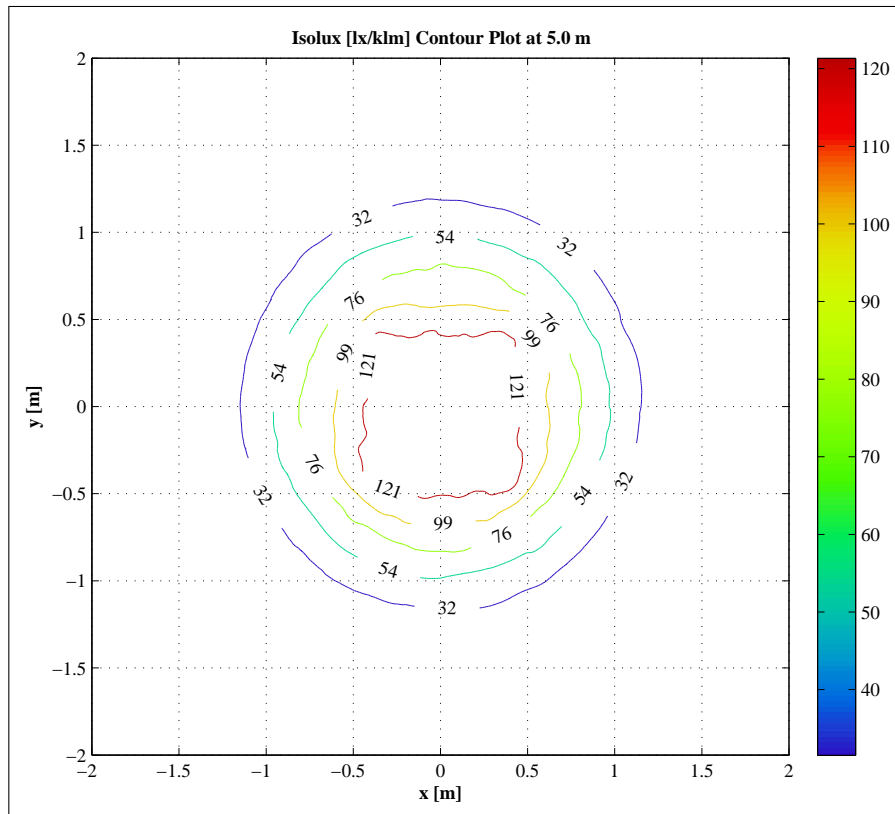

7 Illuminance Diagram

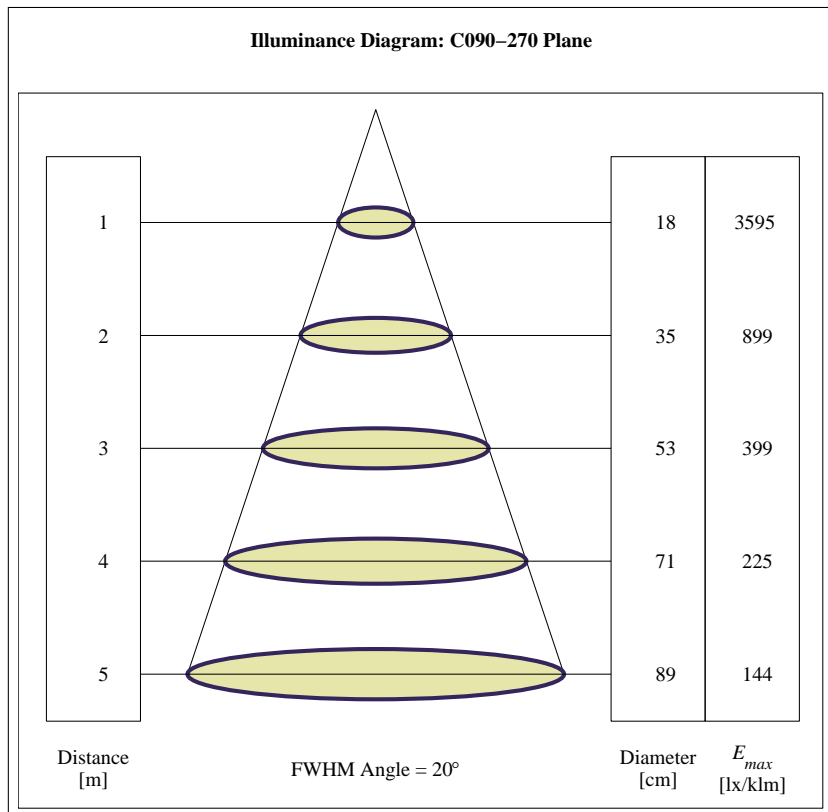
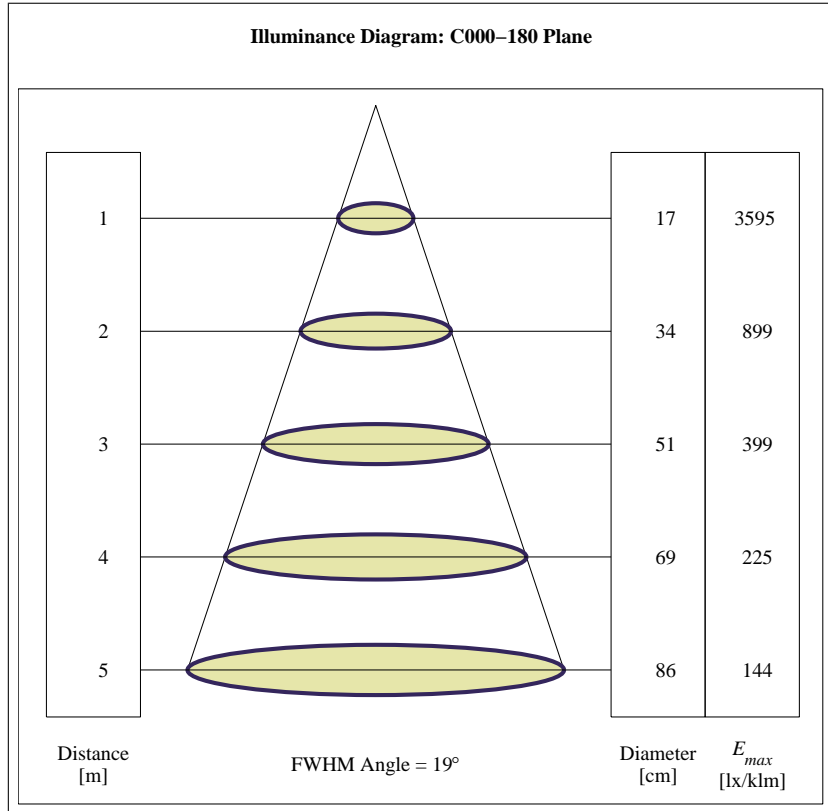

8 Drawing

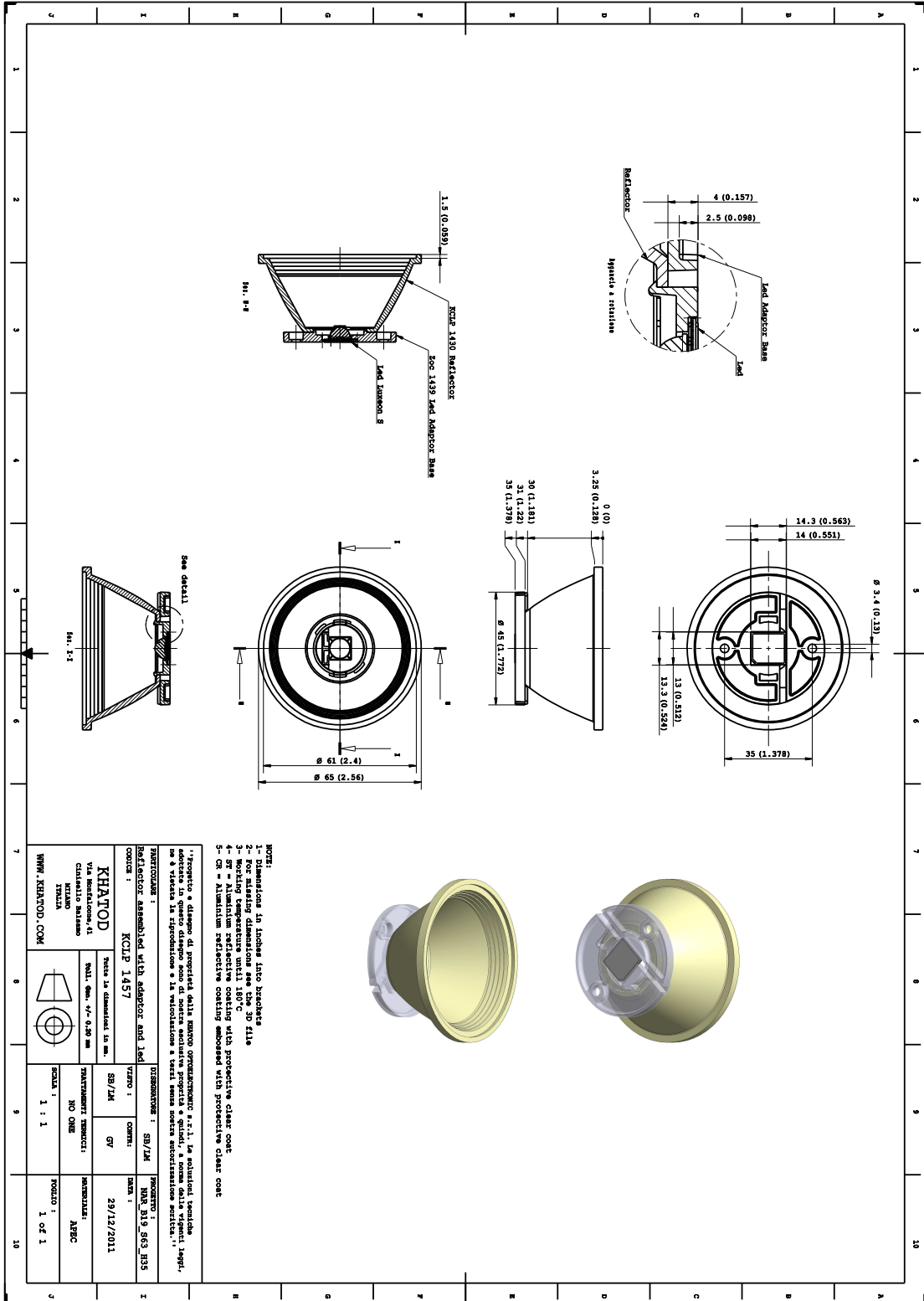

9 Use and Maintenance

Reflector characteristics

Parameter	Symbol	Rating	Unit
Reflector Material	PC , Aluminium Reflective Coating with protective clear coat	--	--
Holder Material	--	--	--
Operating Temperature	Topr	-40 to +180	°C
Storage Temperature	Tstg	-30 to +80	°C

Notes:

Please note that flow lines and weld lines on the external surfaces of the lenses are acceptable if the optical performance of the lens is within the specification described in the section "OPTICAL CHARACTERISTICS"

- Should you require further information, please contact Khatod for advice.
- All lens testing must be subject to identical conditions as Khatod test condition.
- Published by Khatod optoelectronic srl - All the data contained in this document are the property of Khatod optoelectronic srl and may change without notice.

KHATOD LENS Use And Maintenance

- DO NOT HANDLE OR INSTALL LENSES WITHOUT WEARING GLOVES, SKIN OILS MAY DAMAGE LENS OR LIGHT TRANSMISSION
- CLEAN LENSES WITH MILD SOAP AND WATER AND A SOFT CLOTH
- DO NOT USE ANY COMMERCIAL CLEANING SOLVENTS ON LENSES

Khatod SRL, Milan, Italy, manufactures lenses for LEDs. Any other use of the lens shall void our liability and warranty. The lenses are an inert component to be used in the manufacture of various products. Our warranty and liability are limited only to the manufacture of the lens. You may not modify, copy, distribute reproduce, license or alter the lens and related materials of Khatod SRL. Khatod SRL does not warrant against damages or defects arising out of the use or misuse of the products; against defects or damage arising from improper installation, or against defects in the product or in its components. No warranty of any kind, expressed or implied, is made regarding the safety of the products. The entire risk as to the quality or performance of the product is with the buyer. In no event shall Khatod SRL be liable for any direct, indirect, punitive, incidental, special, consequential damages, or any damages whatsoever arising out of or connected with the use or misuse of the product. Khatod SRL shall not have any obligation with respect to the product or any part thereof, whether based on contract, tort, strict liability or otherwise. Buyer assumes all risks and liability from use of the product. The laws of Milan, Italy govern this product warranty and liability and you hereby consent to the exclusive jurisdiction and venue of courts in Milan, Italy in all disputes arising out of or relating to the use of this product. Production, marketing, distribution, sale of these products as well as their possible modifications and variations are only exclusive right of Khatod Optoelectronic S.r.l. No company can perform any of these actions without written permission released by Khatod Optoelectronic S.r.l. - REPRODUCTION PROHIBITED -