

JED CONNECTOR

Board-to-board connectors

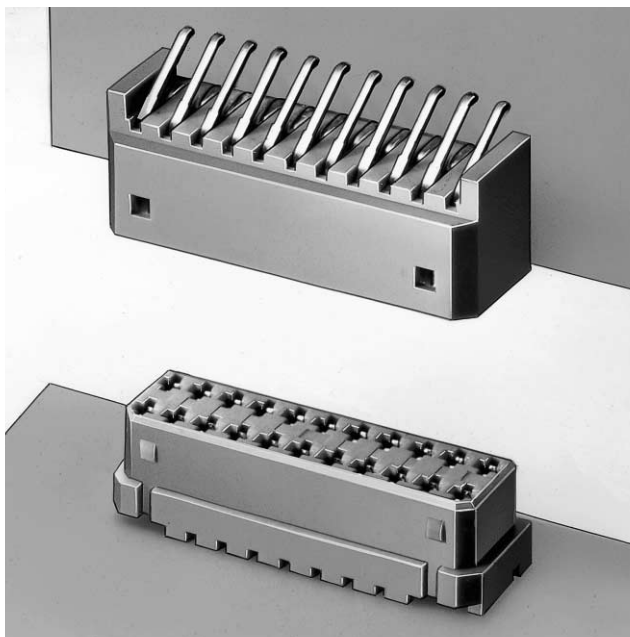

This 1.25mm (.049") pitch dual-in-line connector allows high-density packaging. Double-sided, high-pressure contacts and a housing locking feature provide reliable connections.

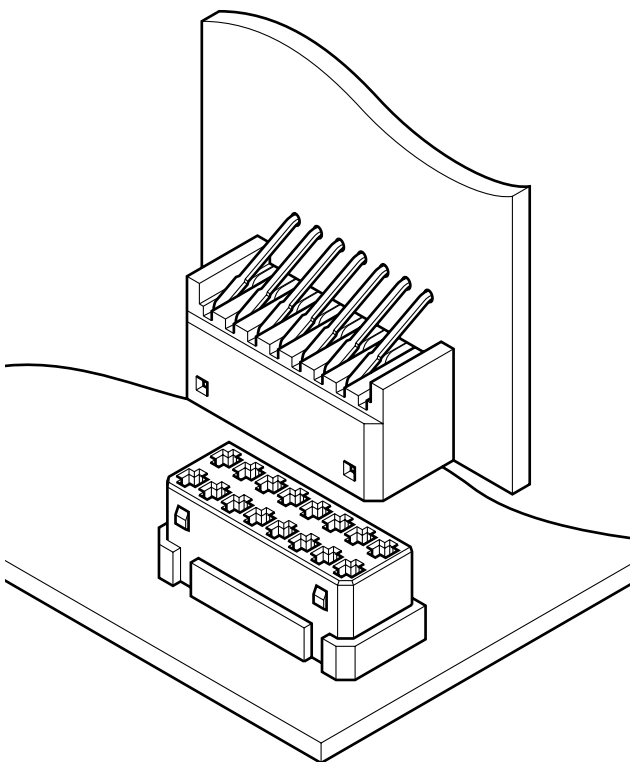

Feature

• Compact, high-density design

This small connector has a 1.25mm (.049") pitch dual-in-line construction at both the mating and printed circuit board sides. It has a mounting height of only 7.0mm (.278") and a thickness of 4.6mm (.181").

• Positive housing lock provides a highly reliable connection

The high-pressure, double-sided, fork type contacts and a housing lock feature ensure continuity even when the connector is subjected to severe vibration or shock.

• Polarized shrouded header

The polarized shrouded header prevents misinsertion or distortion of the receptacle housing during mating. The rigid mating between the plug and receptacle guarantees high reliability during vibration or shock.

Specifications

- Current rating: 1.0A AC, DC
- Voltage rating: 50V AC, DC
- Temperature range: -25°C to +85°C
(including temperature rise in applying electrical current)
- Contact resistance: Initial value/20m Ω max.
After environmental testing/40m Ω max.
- Insulation resistance: 300M Ω min.
- Withstanding voltage: 500V AC/minute
- Applicable PC board thickness: 0.8 to 1.0mm (.031" to .039")
- * Contact JST if Lead-Free product is required.
- * Refer to "General Instruction and Notice when using Terminals and Connectors" at the end of this catalog.
- * Contact JST for details.

Standards

Recognized E60389

Certified LR20812

JED CONNECTOR

Plug

Top entry type

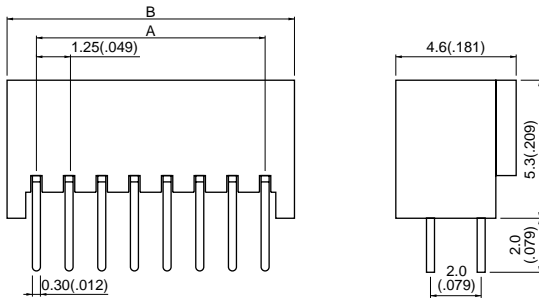

Side entry type

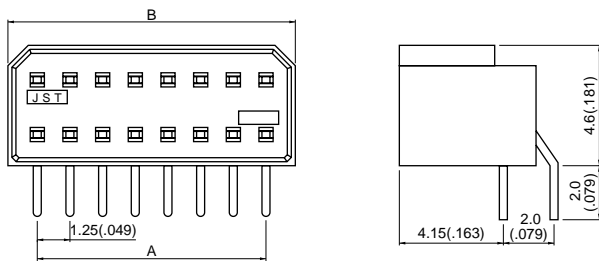

Circuits	Model No.		Dimensions mm(in.)		Q'ty / box
	Top entry type	Side entry type	A	B	
8	08P-JED	08PS-JED	3.75(.148)	5.95(.234)	500
16	16P-JED	16PS-JED	8.75(.344)	10.95(.431)	500
22	22P-JED	22PS-JED	12.50(.492)	14.70(.579)	500

Material and Finish

Contact: Brass, copper-undercoated, tin-plated
Housing: Glass-filled nylon 66, UL94V-0

Receptacle

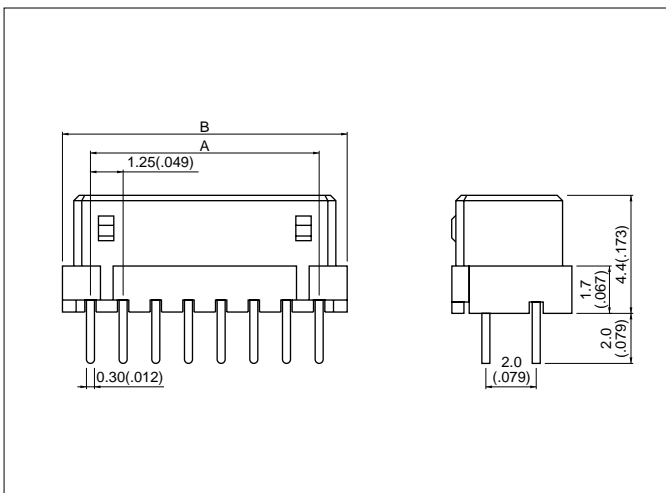

Circuits	Model No.	Dimensions mm(in.)		Q'ty / box
		A	B	
8	08R-JED	3.75(.148)	5.95(.234)	500
16	16R-JED	8.75(.344)	10.95(.431)	500
22	22R-JED	12.50(.492)	14.70(.579)	500

Material and Finish

Contact: Phosphor bronze, copper-undercoated, tin/lead-plated
Housing: Glass-filled nylon 66, UL94V-0

PC board layout (viewed from soldering side)

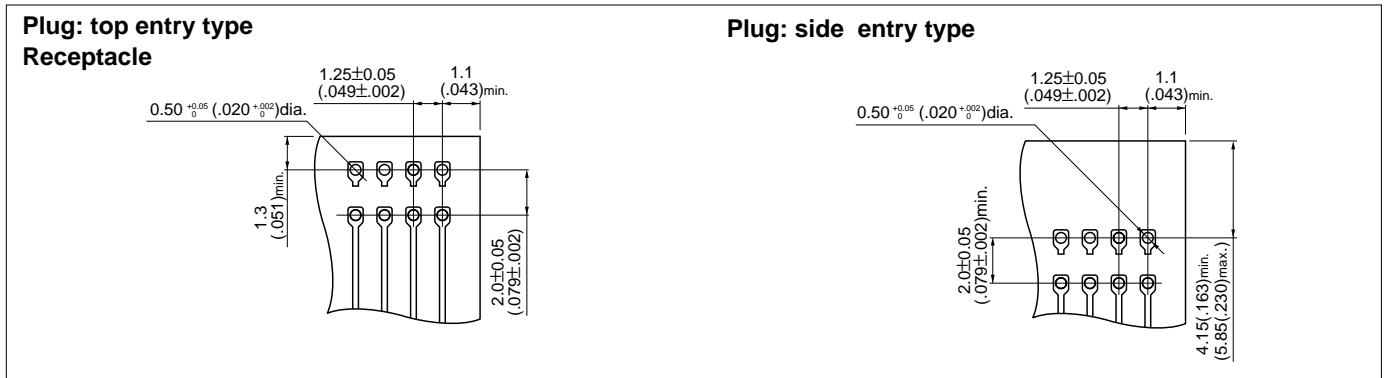

Note:

1. Tolerances are non-cumulative: $\pm 0.05 \text{mm} (\pm .002")$ for all centers.
2. Hole dimensions differ according to the kind of PC board and piercing method. The dimensions above should serve as a guideline.

Assembly layout

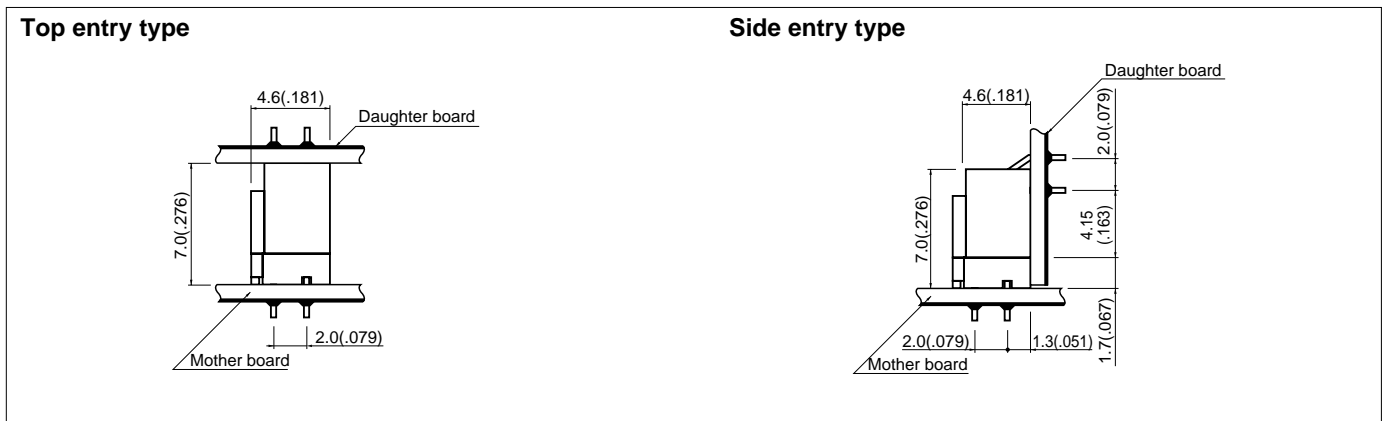

Note: The daughter board must be secured by means other than the connector.
Contact JST for more details.