

FE CONNECTOR

1.25mm pitch/Connectors for FFC

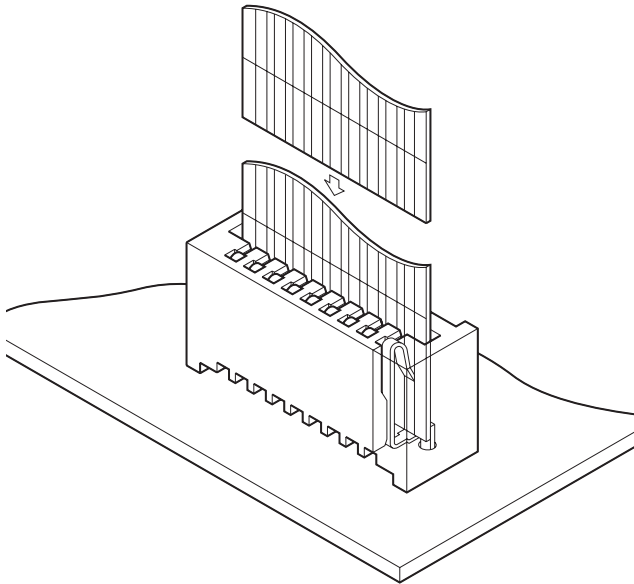
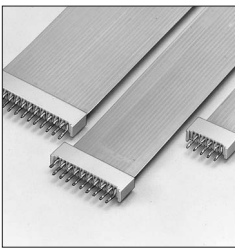

The FE connector ensures easy, secure connection of flexible flat cables (FFC). This compact connector is 4.8mm wide, 7.5mm high, and provides high contact pressure even though little force is required for insertion. The result is smooth insertion and reliable contact performance. The connector is useful in making personal computers, VCRs and car stereo systems smaller and lighter.

- Low insertion force and high contact pressure
- Snap-in connection
- Temporary board retention feature

Specifications

- Current rating: 1.0A AC, DC
- Voltage rating: 200V AC, DC
- Temperature range: -25°C to +85°C
(including temperature rise in applying electrical current)
- Contact resistance: Initial value/20m Ω max.
After environmental testing/30m Ω max.
- Insulation resistance: 1,000M Ω min.
- Withstanding voltage: 500V AC/minute
- Applicable FFC: Conductor pitch/1.25mm
Conductor width/0.8mm
Mating part thickness/0.3±0.05mm

Note: FFC to be actually used should be checked for applicability.

- Applicable PC board thickness: 1.2 to 1.6mm
- * Compliant with RoHS.
- * Refer to "General Instruction and Notice when using Terminals and Connectors" at the end of this catalog.
- * Contact JST for details.

Standards

- Ⓜ Recognized E60389
- Ⓢ Certified LR20812

PC board layout (viewed from component side) and Assembly layout

Top entry type

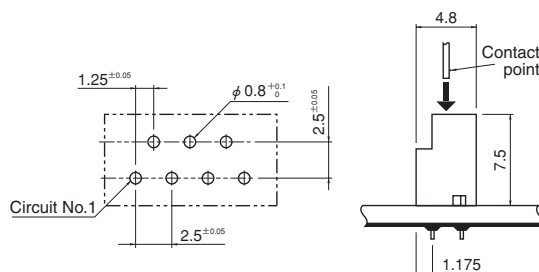

Side entry type

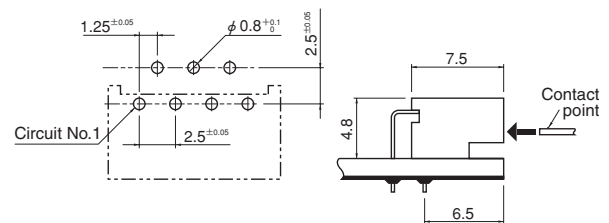

Note: 1. Tolerances are non-cumulative: ±0.05mm for all centers.

2. Hole dimensions differ according to the kind of PC board and piercing method. The dimensions above should serve as a guideline. Contact JST for details.

FE CONNECTOR

Connector

Top entry type

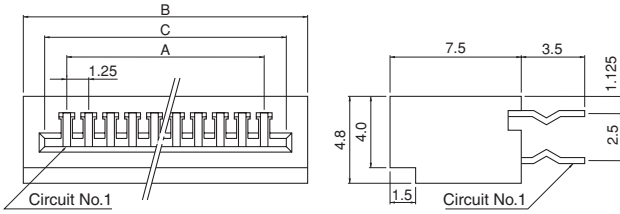

Side entry type

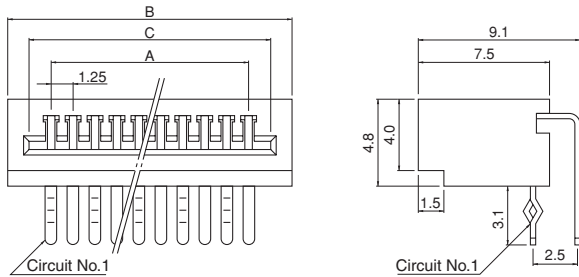

Circuits	Model No.		Dimensions (mm)			Q'ty / box	
	Top entry type	Side entry type	A	B	C	Top entry type	Side entry type
4	04FE-BT-VK-N	04FE-ST-VK-N	3.75	8.55	6.35	2,350	1,410
5	05FE-BT-VK-N	05FE-ST-VK-N	5.00	9.80	7.60	2,000	1,200
6	06FE-BT-VK-N	06FE-ST-VK-N	6.25	11.05	8.85	1,800	1,080
7	07FE-BT-VK-N	07FE-ST-VK-N	7.50	12.30	10.10	1,600	960
8	08FE-BT-VK-N	08FE-ST-VK-N	8.75	13.55	11.35	1,500	900
9	09FE-BT-VK-N	09FE-ST-VK-N	10.00	14.80	12.60	1,350	810
10	10FE-BT-VK-N	10FE-ST-VK-N	11.25	16.05	13.85	1,250	750
11	11FE-BT-VK-N	11FE-ST-VK-N	12.50	17.30	15.10	1,150	690
12	12FE-BT-VK-N	12FE-ST-VK-N	13.75	18.55	16.35	1,100	660
13	13FE-BT-VK-N	13FE-ST-VK-N	15.00	19.80	17.60	1,000	600
14	14FE-BT-VK-N	14FE-ST-VK-N	16.25	21.05	18.85	950	570
15	15FE-BT-VK-N	15FE-ST-VK-N	17.50	22.30	20.10	900	540
16	16FE-BT-VK-N	16FE-ST-VK-N	18.75	23.55	21.35	850	510
17	17FE-BT-VK-N	17FE-ST-VK-N	20.00	24.80	22.60	800	480
18	18FE-BT-VK-N	18FE-ST-VK-N	21.25	26.05	23.85	750	450
19	19FE-BT-VK-N	19FE-ST-VK-N	22.50	27.30	25.10	700	420
20	20FE-BT-VK-N	20FE-ST-VK-N	23.75	28.55	26.35	700	420
21	21FE-BT-VK-N	21FE-ST-VK-N	25.00	29.80	27.60	650	390
22	22FE-BT-VK-N	22FE-ST-VK-N	26.25	31.05	28.85	650	390
23	23FE-BT-VK-N	23FE-ST-VK-N	27.50	32.30	30.10	600	360
24	24FE-BT-VK-N	24FE-ST-VK-N	28.75	33.55	31.35	600	360
25	25FE-BT-VK-N	25FE-ST-VK-N	30.00	34.80	32.60	550	330
26	26FE-BT-VK-N	26FE-ST-VK-N	31.25	36.05	33.85	550	330
27	27FE-BT-VK-N	27FE-ST-VK-N	32.50	37.30	35.10	500	300
28	28FE-BT-VK-N	28FE-ST-VK-N	33.75	38.55	36.35	500	300
29	29FE-BT-VK-N	29FE-ST-VK-N	35.00	39.80	37.60	500	300
30	30FE-BT-VK-N	30FE-ST-VK-N	36.25	41.05	38.85	450	270
31	31FE-BT-VK-N	31FE-ST-VK-N	37.50	42.30	40.10	450	270
32	32FE-BT-VK-N	32FE-ST-VK-N	38.75	43.55	41.35	450	270
33	33FE-BT-VK-N	33FE-ST-VK-N	40.00	44.80	42.60	450	270
34	34FE-BT-VK-N	34FE-ST-VK-N	41.25	46.05	43.85	400	240
35	35FE-BT-VK-N	35FE-ST-VK-N	42.50	47.30	45.10	400	240
36	36FE-BT-VK-N	36FE-ST-VK-N	43.75	48.55	46.35	400	240
37	37FE-BT-VK-N	37FE-ST-VK-N	45.00	49.80	47.60	400	240
38	38FE-BT-VK-N	38FE-ST-VK-N	46.25	51.05	48.85	350	210
39	39FE-BT-VK-N	39FE-ST-VK-N	47.50	52.30	50.10	350	210
40	40FE-BT-VK-N	40FE-ST-VK-N	48.75	53.55	51.35	350	210

Material and Finish

Contact: Copper alloy, tin-plated (reflow treatment)
Housing: PBT, UL94V-0, white

RoHS compliance

Note: 33 to 40 circuits products are not UL/CSA approved.

Lead section dimensions of FFC

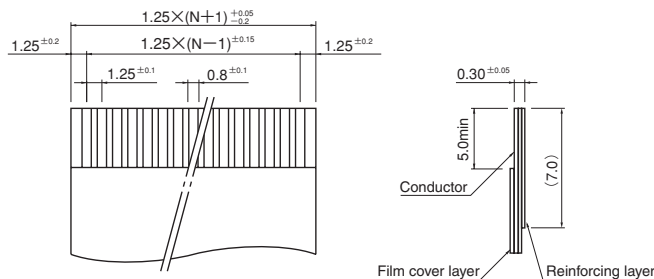

Note: N --- Number of circuits