

REV.	DESCRIPTION	DATE	DESIGNED
-2	Drawing renewal	Dec.26.2000	K. Yuasa

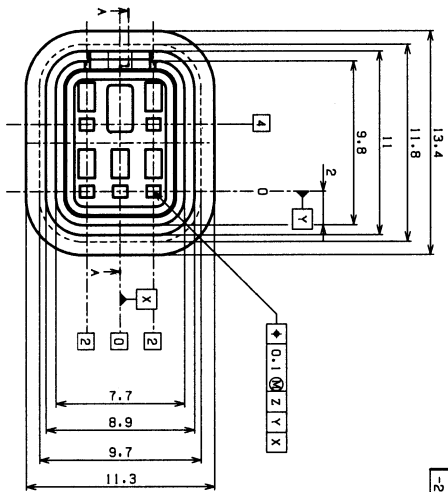

NOTE  
 1. Unless otherwise specified tolerances are  
 1.25:1.0:0.2  
 1.25:1.0:0.3  
 2. Location of circuit number.

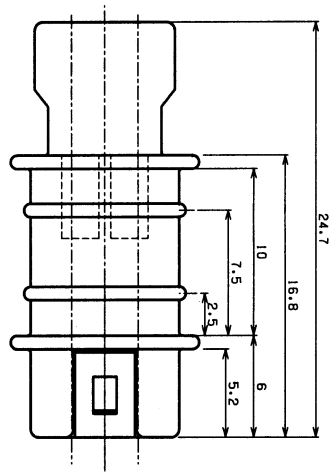
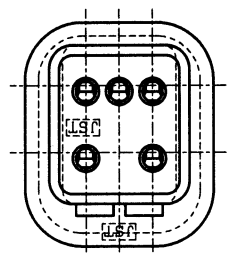
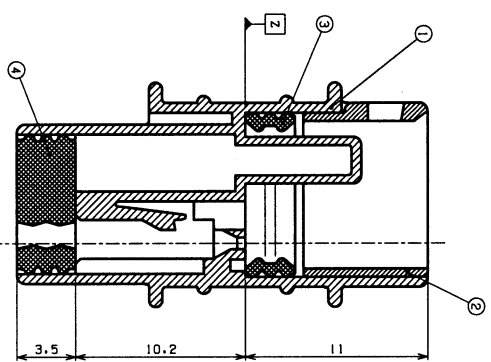
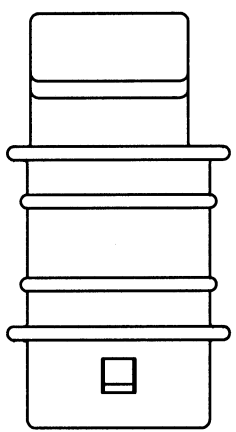
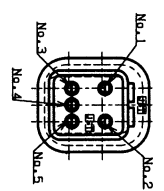

Sect.A-A

NO.	PART NAME	MATERIAL	REMARKS
4	Seal Rubber plate	SI (Light Blue)	
3	Seal Ring	SI (Blue)	
2	Seal Ring holder	PBT (Natural)	UL94HB
1	TAB Housing	PBT (Gray)	UL94HB

APPROVED	DESIGNED	DRAWN	CHECKED
A. Tomita	K. Yuasa	N. Miyata	

DATE	PROJECT	DATE	PROJECT
DEC.26.2000			

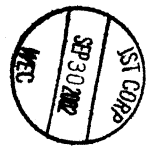

ST J.S.T. MFG. CO., LTD. DRAWING NO. KR0-25667-2

THIS DRAWING CONTAINS INFORMATION THAT IS PROPRIETARY TO J.S.T. AND SHOULD NOT BE USED WITHOUT WRITTEN PERMISSION.