

# MCX 75 Ohm Straight PC Mount Jack Receptacle

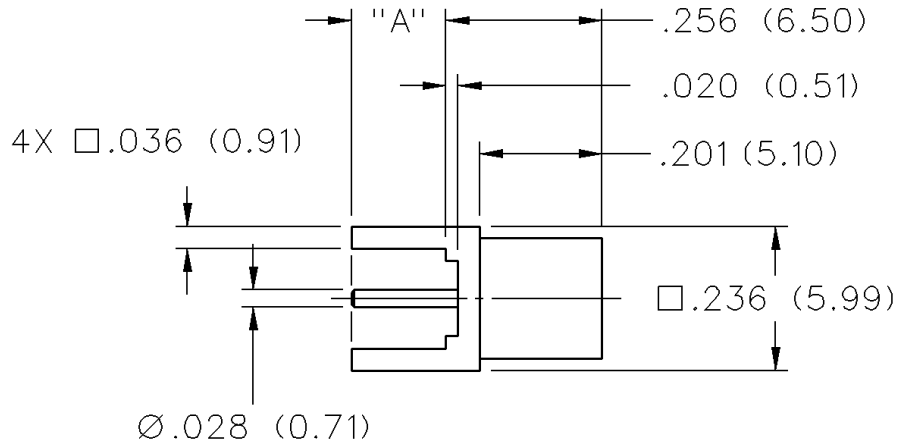

"A"	GOLD PLATED
.110 (2.70)	133-8701-211

Mounting hole layout

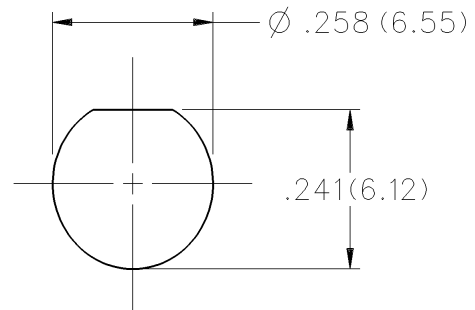

# MCX - 75 Ohm Connectors

## Specifications



INCHES (MILLIMETERS)  
CUSTOMER DRAWINGS AVAILABLE UPON REQUEST

### ELECTRICAL RATINGS

**Impedance:** 75 Ohms

**Frequency Range:** 0-6 GHz

**VSWR:** (f = GHz)

	Straight Cabled Connectors	Right Angle Cabled Connectors
RG-179 cable .....	1.13 + .04f	1.07 + .04f
In-series adapters .....	1.07 + .03f	
Between series adapters, loads ...	1.05 + .01f	
Matching pad .....	1.05 + .05f	
Uncabled receptacles .....		N/A

**Working Voltage:** (Vrms maximum)†

Connectors for Cable Type	Sea Level	70K Feet
RG-179 .....	335	85
Uncabled receptacles, adapters .....	335	85
Loads, matching pad .....	N/A	

**Dielectric Withstanding Voltage:** (VRMS minimum at sea level)†

Connectors for RG-179 .....	1000
Uncabled receptacles, adapters .....	1000
Loads, matching pad .....	N/A

**Corona Level:** (Volts minimum at 70,000 feet)†

Connectors for RG-179 .....	250
Uncabled receptacles, adapters .....	250
Loads, matching pad .....	N/A

**Insertion Loss:** (dB maximum, tested at 1 GHz)

Straight cable connectors .....	0.1 dB
Right angle cable connectors .....	0.2 dB
Uncabled receptacles, adapters, matching pad .....	N/A

**Insulation Resistance:** 10,000 megohms minimum

**Contact Resistance:** (milliohms maximum)

	Initial	After Environmental
Center contact (straight cabled connectors, uncabled receptacles) .....	5.0	8.0
Center contact (right angle cabled connectors) ....	5.0	15.0
Center contact (loads, matching pads) .....	N/A	
Outer contact .....	1.0	1.5
Braid to body (gold plated connectors) .....	1.0	N/A

**RF Leakage:** (dB typical tested at 2.5 GHz)

Cable connectors .....	-55 dB typical
Uncabled receptacles, adapters, loads, matching pads .....	N/A

**RF High Potential Withstanding Voltage:** (Vrms minimum, tested at 4 and 7 MHz)†

Connectors for RG-179 .....	700
Uncabled receptacles, adapters .....	600
Loads, matching pad .....	N/A

**Power Rating:** (Loads and matching pad only) 1.0 watt at +25°C derated linearly to 0.5 watt at +125°C

### MECHANICAL RATINGS

**Engagement Design:** Compatible with CECC 22220, Series MCX 50 Ohm

**Engagement Force:** 5.6 pounds maximum axial force

**Disengagement Force:** 8 pounds maximum axial force, 1 pound min.

**Contact Retention:** 2.3 pounds min. axial force (captivated contacts)  
1 inch-ounce min. torque (uncabled receptacles)

**Cable Retention:**

	Axial Force* (pounds)	Torque (in-oz)
Connectors for RG-179 .....	20	N/A
Connectors for RG179 DS .....	25	N/A

\*or cable breaking strength whichever is less

**ENVIRONMENTAL RATINGS (Meets or exceed the applicable paragraph of MIL-C-39012)**

**Durability:** 500 cycles minimum

**Temperature Range:** All connectors: - 65°C to + 165°C

Loads and matching pads: - 65°C to + 125°C

**Thermal Shock:** MIL-STD-202, Method 107, Condition F

**Temperature Coefficient:** Loads and matching pad: +/- 300ppm/°C

**Corrosion:** MIL-STD-202, Method 101, Condition B

**Shock:** MIL-STD-202, Method 213, Condition B

**Vibration:** MIL-STD-202, Method 204, Condition B

**Moisture Resistance:** MIL-STD-202, Method 106

### MATERIAL SPECIFICATIONS

**Bodies:** Brass per QQ-B-626, gold plated\*\* per MIL-G-45204 .00001" min. Interface spring - beryllium copper per QQ-C-530, gold plated per MIL-G-45204 .00003" min.

**Contacts:** Male - brass per QQ-B-626 or beryllium copper per QQ-C-530, gold plated per MIL-G-45204 .00003" min.

Female - beryllium copper per QQ-C-530, gold plated per MIL-G-45204 .00003" min.

**Insulators:** PTFE fluorocarbon per ASTM D 1710 and ASTM D 1457

**Expansion Caps:** Brass per QQ-B-613, gold plated per MIL-G-45204 .00001" min.

**Crimp Sleeves:** Copper per WW-T-799, gold plated per MIL-G-45204 .00001" min.

**Mounting Hardware:** Brass (nuts) per QQ-B-626 or phosphor bronze (lockwashers) QQ-B-750, gold plated per MIL-G-45204 .00001" min.

†Avoid user injury due to misapplication.

See safety advisory definitions inside front cover.

\*\* All gold plated parts include a .00005" min. nickel underplate barrier layer.

### MATING ENGAGEMENT FOR 75 OHM MCX SERIES (INTERMATEABLE WITH CECC 22220 50 OHM MCX)

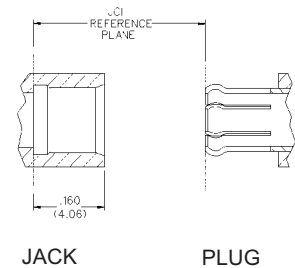
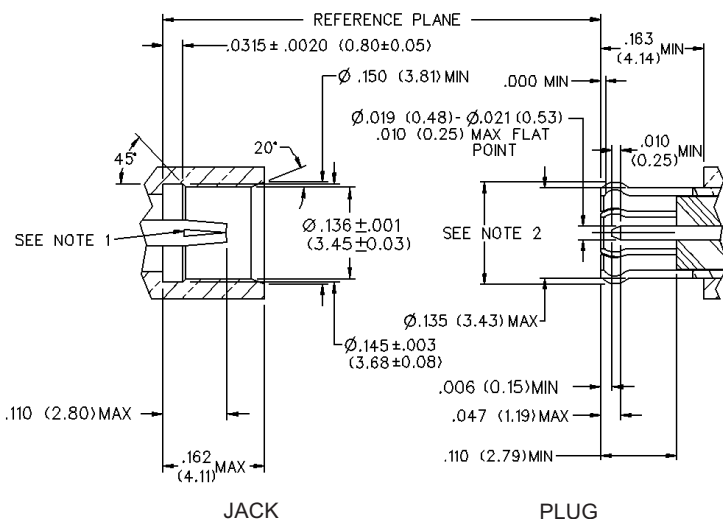

### NOTES

- ID of contact to meet VSWR mating characteristics and connector durability when mated with a dia. .019-.021 (0.48-0.53) male contact.
- Must meet the force to engage and disengage when mated with mating part.
- Interface shall intermate with MCX 50 Ohm interface per CECC 22220.