

OPTIGA™ Trust Charge

Product Version: V1

Key Features

- High-end security controller
- Common Criteria Certified EAL6+ (high) hardware
- Turnkey solution
- Compliant with the USB Type-C™ Authentication standard
- Up to 10kB user memory
- PG-USON-10-2,-4 package (3 x 3 mm)
- Standard & Extended temperature ranges
- I2C interface with Shielded Connection (encrypted communication)
- Cryptographic support: ECC NIST P256/P384, SHA-256, TRNG, DRNG
- Crypto ToolBox commands for SHA-256, ECC NIST P256/P384 (sign, verify and key generation)
- Device Security Monitor
- 4 Monotonic up counters
- Protected (integrity) update of data objects
- Hibernate for zero power consumption¹
- Lifetime for Industrial Automation and Infrastructure is 20 years and 15 years for other Application Profiles
- Wireless Power Consortium(WPC) Authentication

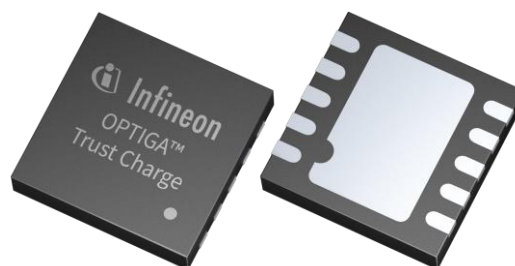

Benefits

- Protection of data
- Protection of business case
- Protection of corporate image
- Safeguarding of quality and safety

Applications

- Consumer electronics
- Smart Home
- Drones

About this document

Scope and purpose

This Datasheet provides information to enable integration of a security device, and includes package, connectivity and technical data.

¹ Leakage current < 2.5µA only

Table of Contents

Intended audience

This Datasheet is intended for device integrators and board manufacturers.

Table of Contents

About this document	1
Table of Contents	2
1 Introduction	4
1.1 Broad range of benefits.....	4
1.2 Enhanced security.....	4
1.3 Fast and easy integration.....	4
1.4 Applications.....	4
1.5 Device Features	4
2 System Block Diagram	6
3 Interface and Schematics	8
3.1 System Integration Schematics.....	8
3.2 System Integration Schematics with Hibernation support.....	8
4 Description of packages	9
4.1 PG-USON-10-2,-4	9
4.2 Production sample marking pattern	10
5 Technical Data	12
5.1 I2C Interface Characteristics	12
5.1.1 I2C Standard/Fast Mode Interface Characteristics	12
5.1.2 I2C Fast Mode Plus Interface Characteristics	13
5.1.3 Electrical Characteristics	14
5.1.3.1 DC Electrical Characteristics.....	14
5.1.3.2 AC Electrical Characteristics.....	14
5.1.4 Start-Up of I2C Interface	15
5.1.4.1 Startup after Power-On	15
5.1.4.2 Startup for Warm Resets.....	16
6 Connecting to Host	18
6.1 OPTIGA™ Trust Charge Host Software Architecture	18
6.2 Release Package Folder Structure.....	18
6.3 Porting Notes.....	20
6.4 Communication with OPTIGA™ Trust Charge	20
6.5 Reference code for communicating with OPTIGA™ Trust Charge	23
7 OPTIGA™ Trust Charge External Interface	25
7.1 Commands	25
7.2 Crypto Performance	25
8 Security Monitor	27
8.1 Security Events.....	27
8.2 Security Monitor Policy	27
9 RoHS Compliance	28
10 Appendix A – Infineon I2C Protocol Registry Map	29
10.1 Infineon I2C Protocol Variations	31
11 Appendix B - OPTIGA™ Trust Charge Command/Response I2C Sample Logs	33
11.1 Sequence of commands to read Coprocessor UID from OPTIGA™ Trust Charge	33
11.1.1 Check the status [I2C_STATE].....	33



Table of Contents

11.1.2 Issue OpenApplication command 33

11.1.3 Read Coprocessor UID 34

12 Appendix C – Power Management 35

12.1 Hibernation..... 35

12.2 Low Power Sleep Mode 35

Revision history..... 36

Introduction

1 Introduction

As embedded systems (e.g. IoT devices) are increasingly gaining the attention of attackers, Infineon offers the OPTIGA™ Trust Charge as an authentication solution for wireless power charging applications. This high-end security controller comes with full system integration support for easy and cost-effective deployment of high-end security for your assets.

1.1 Broad range of benefits

Integrated into your device, the OPTIGA™ Trust Charge supports protection of your brand and business case, differentiates your product from your competitors, and adds value to your product, making it stronger against cyberattacks.

1.2 Enhanced security

The OPTIGA™ Trust Charge is based on an advanced security controller with built-in tamper proof NVM for secure storage and Symmetric/Asymmetric crypto engines to support ECC 256/384 and SHA-256. This new security technology greatly enhances your overall system security.

1.3 Fast and easy integration

The turnkey setup – with full system integration and all key/certificate material preprogrammed – reduces your efforts for design, integration and deployment to a minimum. As a turnkey solution, the OPTIGA™ Trust Charge comes with preprogrammed OS/Application code locked and with host-side modules to integrate with host micro controller software. The temperature range of –40°C to +105°C combined with a standardized I2C interface and the small PG-USON-10-2,-4 footprints will facilitate onboarding in your existing ecosystem. Almost 30 years in a market-leading position with nearly 20 billion security controllers shipped worldwide are the results of Infineon's strong expertise and its commitment to make security a success factor for you.

1.4 Applications

The OPTIGA™ Trust Charge covers a broad range of use cases necessary for many types of applications that include the following:

- a) Protect the Authenticity, Integrity and Confidentiality of your product and data
- b) Datastore Protection
- c) Lifecycle Management

1.5 Device Features

The OPTIGA™ Trust Charge comes with up to 10 kB user memories that can be used to store WPC certificates and data. OPTIGA™ Trust Charge is based on Common Criteria (CC) Certified EAL6+ (high) hardware enabling it to prevent physical attacks on the device itself and providing high assurance that the keys or arbitrary data stored cannot be accessed by an unauthorized entity. The CC certificate can be found at www.bsi.bund.de by searching for BSI-DSZ-CC-0961(Hardware Identifier IFX_CCI_00000Bh) and referring to the latest CC certificate. OPTIGA™ Trust Charge supports a highspeed I2C communication interface of up to 1MHz (FM+).

Table 1 Products

OPTIGA™ Trust Charge

Introduction

Type	Description	Temperature range	Package
OPTIGA™ Trust Charge SLS 32AIA020U2	Embedded security solution for connected devices	-25°C to +85°C Standard Temperature Range (STR)	PG-USON-10-2,-4
OPTIGA™ Trust Charge SLS 32AIA020U3	Embedded security solution for connected devices	-40°C to +105°C Extended Temperature Range (ETR)	PG-USON-10-2,-4
Evaluation Kit	Provides all the components required to set up the environment to demonstrate the features of the OPTIGA™ Trust Charge		Board

Infineon and its distribution partners offer a wide range of customization options (e.g. WPC certificate generation and key provisioning) for the security chip.

Table 2 Abbreviations

Abbreviation	Definition
AES	Advanced Encryption Standard
API	Application Programming Interface
CA	Certification Authority
CC	Common Criteria
DRNG	Deterministic Random Number Generator
EAL	Evaluation Assurance Level
ECC	Elliptic Curve Cryptography
ECDSA	Elliptic Curve Digital Signature Algorithm
I2C	Inter-Integrated Circuit
IETF	Internet Engineering Task Force
IFX	Infineon
IOT	Internet of Things
IP	Intellectual Property
NIST	National Institute of Standards and Technology
OS	Operating System
PAL	Platform Abstraction Layer
PKI	Public Key Infrastructure
RFC	Request For Comments
SHA	Secure Hash Algorithm
SKU	Stock Keeping Unit
STR	Standard Temperature Range
TRNG	True Random Number Generator
USB	Universal Synchronous Bus
WPC	Wireless Power Consortium

OPTIGA™ Trust Charge

System Block Diagram

2 System Block Diagram

The following figure depicts the system block diagram for OPTIGA™ Trust Charge.

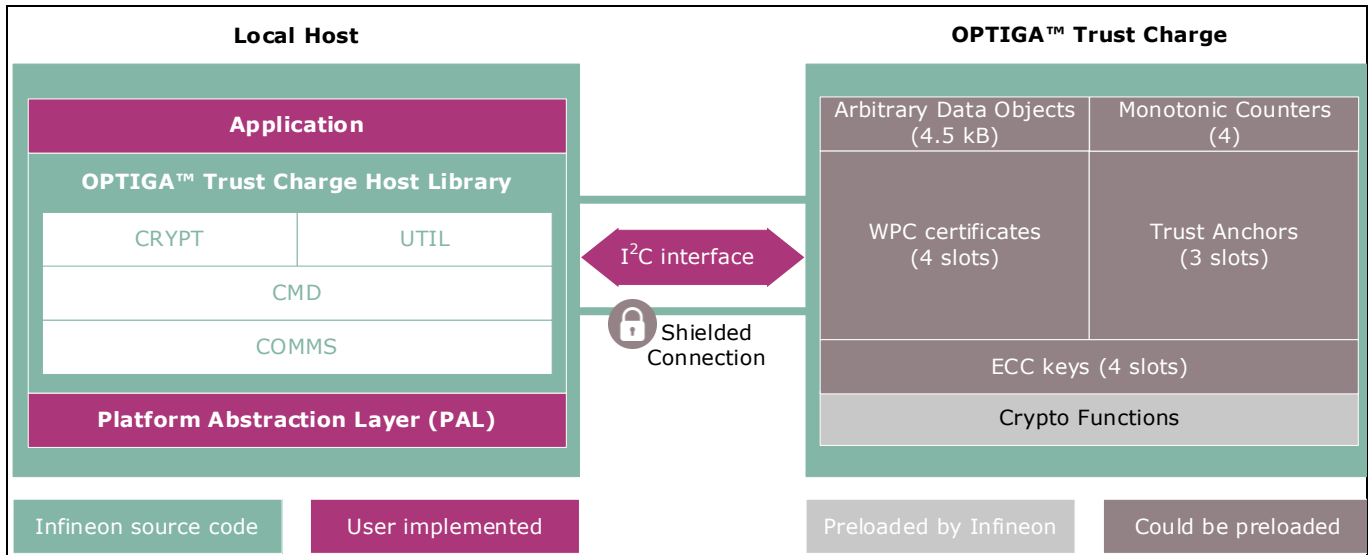

Figure 1 System Block Diagram

The System Block Diagram is explained below for each layer.

1. Local Host

- Local Host Application – This is the target application which utilizes OPTIGA™ Trust Charge for its security needs
- OPTIGA™ Trust Charge Host Library
 - CRYPT – Provides APIs to perform cryptographic functionalities.
 - UTIL – Provides APIs such as read/write, protected update of data objects and open/close application (e.g. Hibernate)
 - CMD – Provides APIs to send and receive commands (Section 7) to and from OPTIGA™ Trust Charge
 - COMMS – Provides wrapper APIs for communication (optional encrypted communication using Shielded Connection) with OPTIGA™ Trust Charge which internally uses Infineon I2C Protocol (IFX I2C)
- PAL – A layer that abstracts platform specific drivers (e.g. I2C, Timer, GPIO, platform crypto library etc.)

2. OPTIGA™ Trust Charge

- Arbitrary Data Objects – The target application can store up to 4.5kB (~4600 bytes) of data into OPTIGA™ Trust Charge. The data could be additional Trust Anchors, certificates and shared secret.
- Monotonic Counters - Provides 4 monotonic counting data objects (up counters). These can be used as general purpose counter or as linked counter to other objects.
For more information, please refer to Solution Reference Manual document available as part of the package.
- WPC Certificates – Up to 4 WPC Certificate chains can be stored
- Keys – Up to 4 ECC based keys can be stored

OPTIGA™ Trust Charge

System Block Diagram

- Trust Anchors – 3 slots
- Crypto Functions - OPTIGA™ Trust Charge provides cryptographic functions that can be invoked via local host

Note: Unique ECC private keys and WPC Certificates – During production at Infineon fab, unique asymmetric keys (private and public) are generated. The public key is signed by customer specific CA and the resulting WPC certificate issued is securely stored in the OPTIGA™ Trust Charge. Special measures are taken to prevent the leakage and modification of private key material at the Common Criteria Certified production site

OPTIGA™ Trust Charge

Interface and Schematics

3 Interface and Schematics

This section explains the schematics of the product and gives some recommendations as to how the controller should be externally connected.

3.1 System Integration Schematics

The following figure illustrates how to integrate OPTIGA™ Trust Charge with your local host.

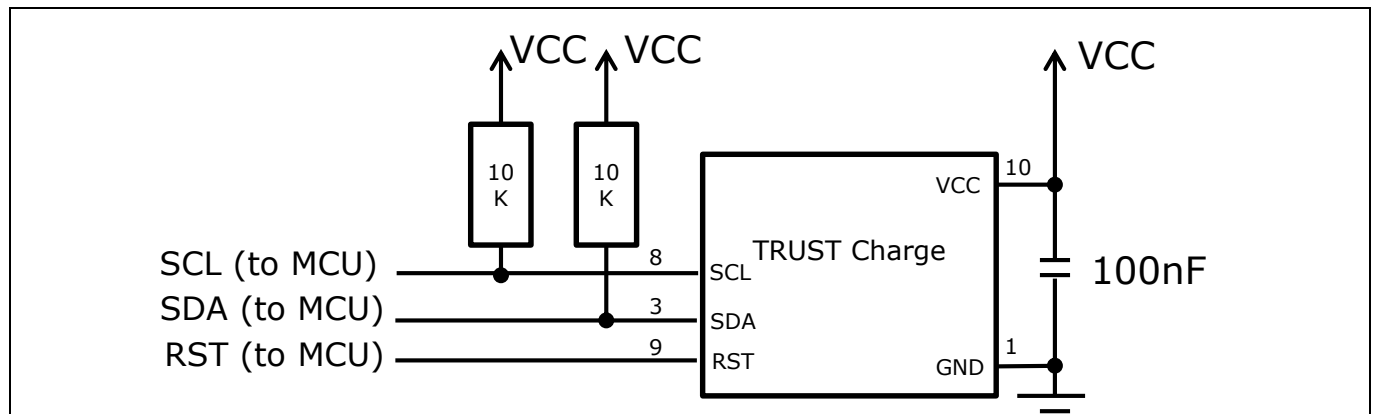

Figure 2 System Integration Schematic Diagram

Note: Value of the pullup resistors depend on the target application circuit and the targeted I2C frequency.

3.2 System Integration Schematics with Hibernation support

The following figure illustrates how to integrate OPTIGA™ Trust Charge with hibernation, with your local host.

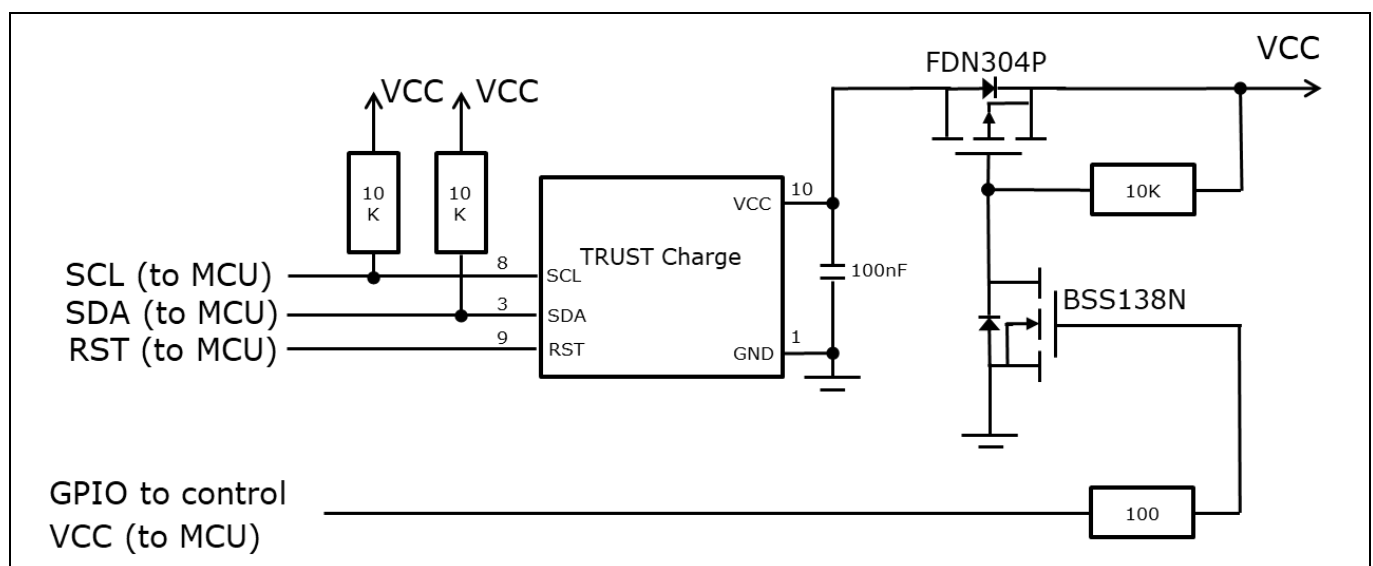

Figure 3 System Integration Schematic Diagram with Hibernation

Note: Value of the pullup resistors depend on the target application circuit and the targeted I2C frequency.

4 Description of packages

This chapter provides information on the package types and how the interfaces of each product are assigned to the package pins. For further information on compliance of the packages with European Parliament Directives, see “RoHS Compliance” on Page 28.

For details and recommendations regarding the assembly of packages on PCBs, please see the following: <http://www.infineon.com/cms/en/product/technology/packages/>

4.1 PG-USON-10-2,-4

The package dimensions (in mm) of the controller in PG-USON-10-2,-4 packages are given below.

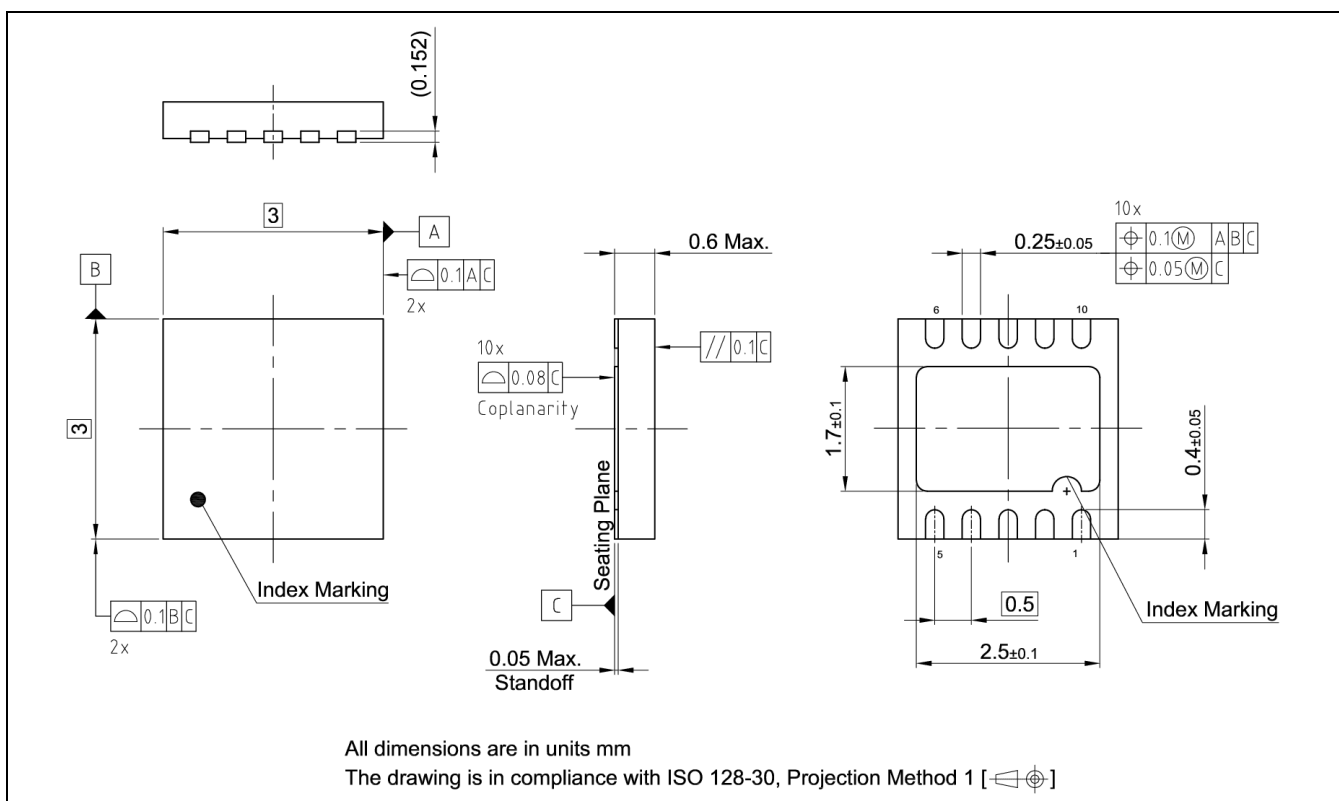

Figure 4 PG-USON-10-2,-4 Package Outline

The following figure shows the PG-USON-10-2,-4 in top view:

OPTIGA™ Trust Charge

Description of packages

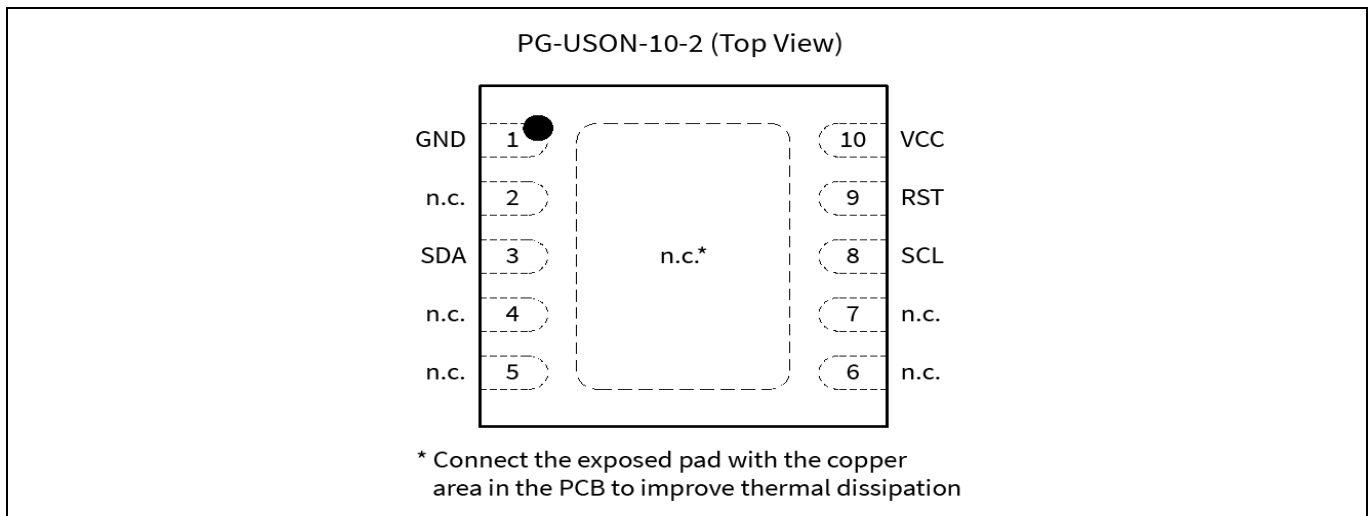

Figure 5 PG-USON-10-2,-4 top view

4.2 Production sample marking pattern

The following figure describes the productive sample marking pattern on PG-USON-10-2,-4.

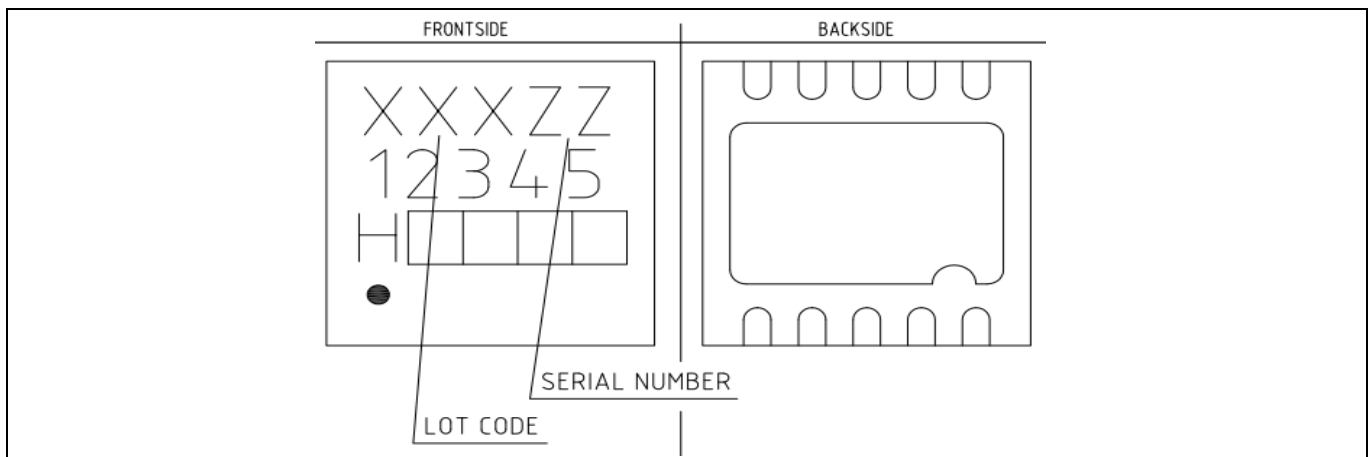

Figure 6 PG-USON-10-2,-4 sample marking pattern

The black dot indicates pin 01 for the chip. The following [Table 3](#) describes the sample marking pattern:

Table 3 Marking table for PG-USON-10-2,-4 packages

Indicator	Description
LOT CODE	Defined and inserted during fabrication
ZZ	Indicates the Certifying Authority Serial Number / SKU#, e.g. "00" would mean "SKU#00"
H/E	H = "Halogen-free", E = "Engineering samples" This indicator is followed by "YYWW", where YY is the "Year" and WW is the "Work Week" of the production. This is inserted during fabrication. Engineering samples have "E YYWW" and productive samples have "H YYWW"

OPTIGA™ Trust Charge

Description of packages

Indicator	Description
12345	<p>Convention: T#&\$@ where:</p> <ul style="list-style-type: none"> • The letter "T" indicates the OPTIGA Trust family • & indicates the product is a Trust Charge controller • # indicates the controller is a STR (S) variant • \$ specifies the OPTIGA™ Trust Charge release version number • @ specifies the software version <p>Example: "TCS10" means 'OPTIGA™ Trust Charge', 'STR variant', 'release version 1', 'software version 0'</p>

The contacts and their functionality are given in the [Table 4](#) below.

Table 4 Contact definitions and functions of PG-USON-10-2,-4 packages

Pin	Type	Function
01	GND	Supply voltage (Ground)
02	NC	Not connected / Do not connect externally
03	I/O	Serial Data Line (SDA)
04	NC	Not connected / Do not connect externally
05	NC	Not connected / Do not connect externally
06	NC	Not connected / Do not connect externally
07	NC	Not connected / Do not connect externally
08	I/O	Serial Clock Line (SCL)
09	IN	Active Low Reset (RST)
10	PWR	Supply voltage (V _{CC})

Technical Data

5 Technical Data

This section summarizes the technical data of the product. It provides the operational characteristics as well as the electrical DC and AC characteristics.

5.1 I2C Interface Characteristics

Table 5 I2C Operation Supply and Input Voltages

Parameter	Symbol	Values			Unit	Note or Test Condition
		Min.	Typ.	Max.		
Supply voltage	V_{CC_I2C}	1.62	–	5.5	V	
SDA, SCL input voltage	V_{IN_I2C}	–0.3	–	$V_{CC_I2C} + 0.5$ or 5.5 ¹	V	V_{CC_I2C} is in the operational supply range
		–0.3	–	5.5	V	V_{CC_I2C} is switched off

1) Whichever is lower

5.1.1 I2C Standard/Fast Mode Interface Characteristics

For operation of the I2C interface, the electrical characteristics are compliant with the I²C bus specification Rev. 4 for "standard-mode" (f_{SCL} up to 100 kHz) and "fast-mode" (f_{SCL} up to 400 kHz), with certain deviations as stated in the table below.

Note: T_A as given for the operating temperature range of the controller unless otherwise stated.

Table 6 I2C Standard Mode Interface Characteristics

Parameter	Symbol	Values			Unit	Note or Test Condition
		Min.	Typ.	Max.		
SCL clock frequency	f_{SCL}	0	–	100	kHz	
Input low-level	V_{IL}	–0.3	–	$0.3 * V_{CC_I2C}$	V	
Low-level output voltage	V_{OL1}	0	–	0.4	V	Sink current 3 mA; $V_{CC_I2C} \geq 2.7$ V Sink current 2 mA; $V_{CC_I2C} < 2.7$ V
Low-level output current	I_{OL}	3 2	–	–	mA	$V_{OL} = 0.4$ V; $V_{CC_I2C} \geq 2.7$ V $V_{OL} = 0.4$ V; $V_{CC_I2C} < 2.7$ V
Output fall time from V_{IHmin} to V_{ILmax} (at device pin)	t_{OF}	–	–	250	ns	$C_b \leq 400$ pF; $V_{CC_I2C} \geq 2.7$ V $C_b \leq 200$ pF; $V_{CC_I2C} < 2.7$ V
Capacitive load for each bus line	C_b	–	–	400	pF	$V_{CC_I2C} \geq 2.7$ V $V_{CC_I2C} < 2.7$ V
				200		

Table 7 I2C Fast Mode Interface Characteristics

Parameter	Symbol	Values			Unit	Note or Test Condition
		Min.	Typ.	Max.		
SCL clock frequency	f_{SCL}	0	–	400	kHz	
Input low-level	V_{IL}	–0.3	–	$0.3 * V_{CC_I2C}$	V	
Low-level output voltage	V_{OL1}	0	–	0.4	V	Sink current 3 mA; $V_{CC_I2C} \geq 2.7 V$ Sink current 2 mA; $V_{CC_I2C} < 2.7 V$
Low-level output current	I_{OL}	3 2	–	–	mA	$V_{OL} = 0.4 V; V_{CC_I2C} \geq 2.7 V$ $V_{OL} = 0.4 V; V_{CC_I2C} < 2.7 V$
Output fall time from V_{IHmin} to V_{ILmax} (at device pin)	t_{OF}	20 * $V_{CC_I2C} / 5.5 V^1$	–	250	ns	$C_b \leq 400 pF; V_{CC_I2C} \geq 2.7 V$ $C_b \leq 200 pF; V_{CC_I2C} < 2.7 V$
Capacitive load for each bus line	C_b	15 ²	–	400 200	pF	$V_{CC_I2C} \geq 2.7 V$ $V_{CC_I2C} < 2.7 V$

1) A min. capacitive load is necessary to reach t_{OF}

2) A min. capacitive load is necessary to reach t_{rmin}

5.1.2 I2C Fast Mode Plus Interface Characteristics

For operation of the I2C interface, the electrical characteristics are compliant with the I²C bus specification Rev. 4 for "fast mode plus" (f_{SCL} up to 1 MHz), with certain deviations as stated in the table below.

Note: T_A as given for the operating temperature range of the controller unless otherwise stated.

Table 8 I2C Fast Mode Plus Interface Characteristics

Parameter	Symbol	Values			Unit	Note or Test Condition
		Min.	Typ.	Max.		
SCL clock frequency	f_{SCL}	0	–	1000	kHz	
Input low-level	V_{IL}	–0.3	–	$0.3 * V_{CC_I2C}$	V	
Low-level output voltage	V_{OL1}	0	–	0.4	V	Sink current 3 mA; $V_{CC_I2C} \geq 2.7 V$ Sink current 2 mA; $V_{CC_I2C} < 2.7 V$
Low-level output current	I_{OL}	3 2	–	–	mA	$V_{OL} = 0.4 V; V_{CC_I2C} \geq 2.7 V$ $V_{OL} = 0.4 V; V_{CC_I2C} < 2.7 V$
Output fall time from V_{IHmin} to V_{ILmax} (at device pin)	t_{OF}	20 * $V_{CC_I2C} / 5.5 V^1$	–	120	ns	$C_b \leq 150 pF$
Capacitive load for each bus line	C_b	15 ¹	–	150	pF	

1) A min. capacitive load is necessary to reach t_{OF}

OPTIGA™ Trust Charge

Technical Data

5.1.3 Electrical Characteristics

Note: T_A as given for the operating temperature range of the controller unless otherwise stated. All currents flowing into the controller are considered positive.

5.1.3.1 DC Electrical Characteristics

T_A as given for the controller's operating ambient temperature range unless otherwise stated. All currents flowing into the controller are considered positive.

Table 9 Electrical Characteristics

Parameter	Symbol	Values			Unit	Note or Test Condition
		Min.	Typ.	Max.		
Supply voltage	V_{CC}	1.62	–	5.5	V	Overall functional range
	V_{CC_I2C}	1.62	–	5.5	V	Supply voltage range for operation of I2C
Supply current ¹	I_{CCAVG}	–	14.0	–	mA	While running a typical authentication profile $T_A = 25^\circ\text{C}$; $V_{CC} = 5.0\text{ V}$
Supply current, in sleep mode	I_{CCS3}	–	70	100	μA	$T_A = 25^\circ\text{C}$; $V_{CC_I2C} = 3.3\text{ V}$; I2C ready for operation (no bus activity), all other inputs at V_{CC} , no other interface activity
RST input low voltage	V_{IL}	–0.3	–	$0.3 * V_{CC}$	V	$I_{IL} = -50\ \mu\text{A}$ to $+20\ \mu\text{A}$
RST input high voltage	V_{IH}	$0.7 * V_{CC}$	–	$V_{CC} + 0.3$	V	$I_{IL} = -50\ \mu\text{A}$ to $+20\ \mu\text{A}$
Hibernate current	–	–	< 2.5	–	μA	$V_{CC} = 0\text{ V}$, $\text{GND} = 0\text{ V}$, $\text{RST} = 0\text{ V}$, $\text{SCL} = 3.3\text{ V}$ and $\text{SCL} = 3.3\text{ V}$

1) Supply current can be limited from 6mA to 15mA by software commands.

5.1.3.2 AC Electrical Characteristics

T_A as given for the controller's operating ambient temperature range unless otherwise stated. All currents flowing into the controller are considered positive.

Table 10 AC Characteristics

Parameter	Symbol	Values			Unit	Note or Test Condition
		Min.	Typ.	Max.		
V_{CC} rampup time	t_{VCCR}	1	–	1000	μs	400 mV to 90% of V_{CC} target voltage ramp

The V_{CC} ramp is depicted in [Figure 7](#). 90% of the target supply voltage must be reached within t_{VCCR} after it has exceeded 400 mV. Moreover, its variation must be kept within a $\pm 10\%$ range.

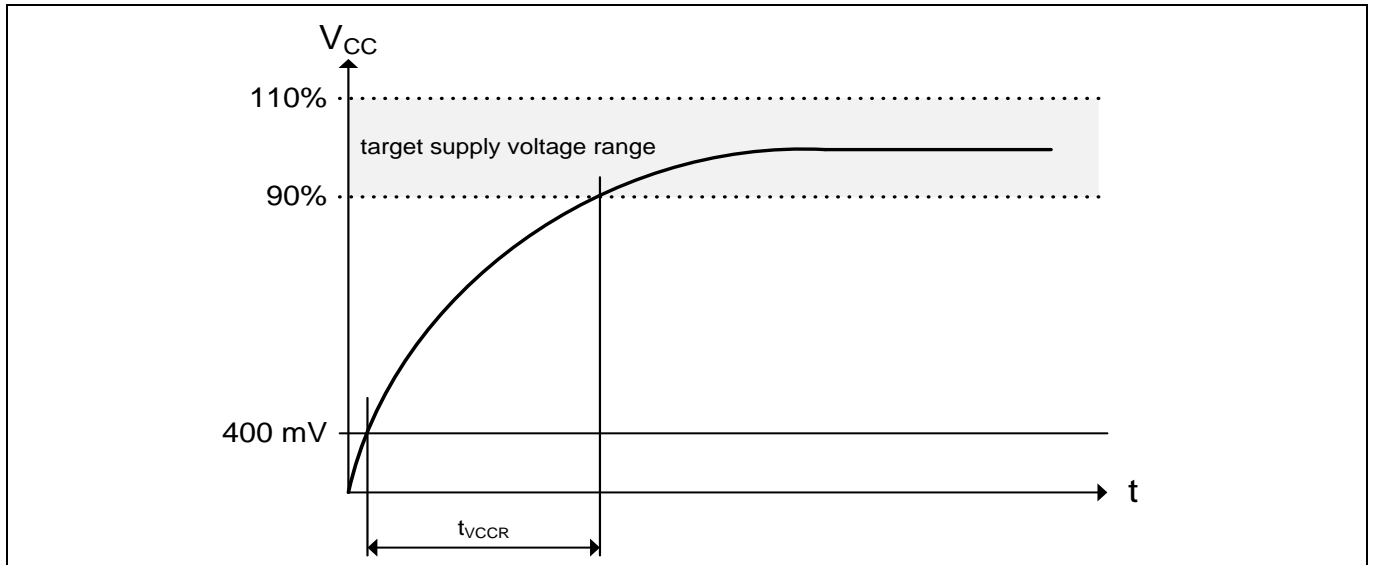

Figure 7 **V_{CC} Rampup**

5.1.4 Start-Up of I2C Interface

There are 2 variants possible for performing the startup procedure:

- Startup after power-on
- Startup for warm resets

5.1.4.1 Startup after Power-On

The activation of the I2C interface after power-on needs the following reset procedure.

- VCC is powered up and the state of the SDA and SCL line are set to high level during power-up
- The first transmission may start at the earliest $t_{STARTUP}$ after power-up of the device

The following figure shows the startup timing of the I2C interface for this case.

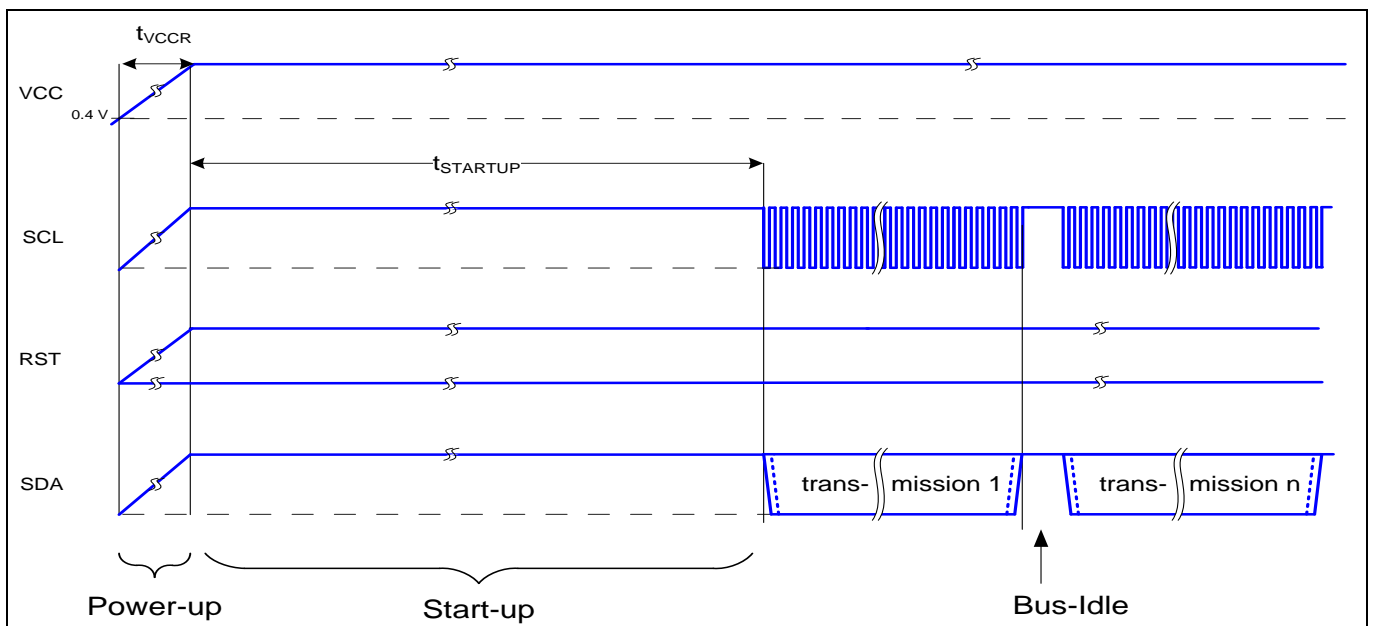

Figure 8 **Startup of I2C Interface after Power-On**

OPTIGA™ Trust Charge

Technical Data

Table 11 Startup of I2C Interface After Power-On

Parameter	Symbol	Values			Unit	Note or Test Condition
		Min.	Typ.	Max.		
Startup time	$t_{STARTUP}$	15			ms	

5.1.4.2 Startup for Warm Resets

When using the reset signal for triggering a warm reset after power-on, the activation of the I2C interface needs the following reset procedure

- VCC remains powered up.
- The terminal stops I2C communication. SDA and SCL lines are set to high level before RST is set to low level.
- After its falling edge, RST has to be kept at low level for at least t_1 . At the latest t_2 after the falling edge of RST, the terminal must set RST to high level.
- The first transmission may start at the earliest $t_{STARTUP}$ after the rising edge of RST

The following figure shows the timing for this startup case.

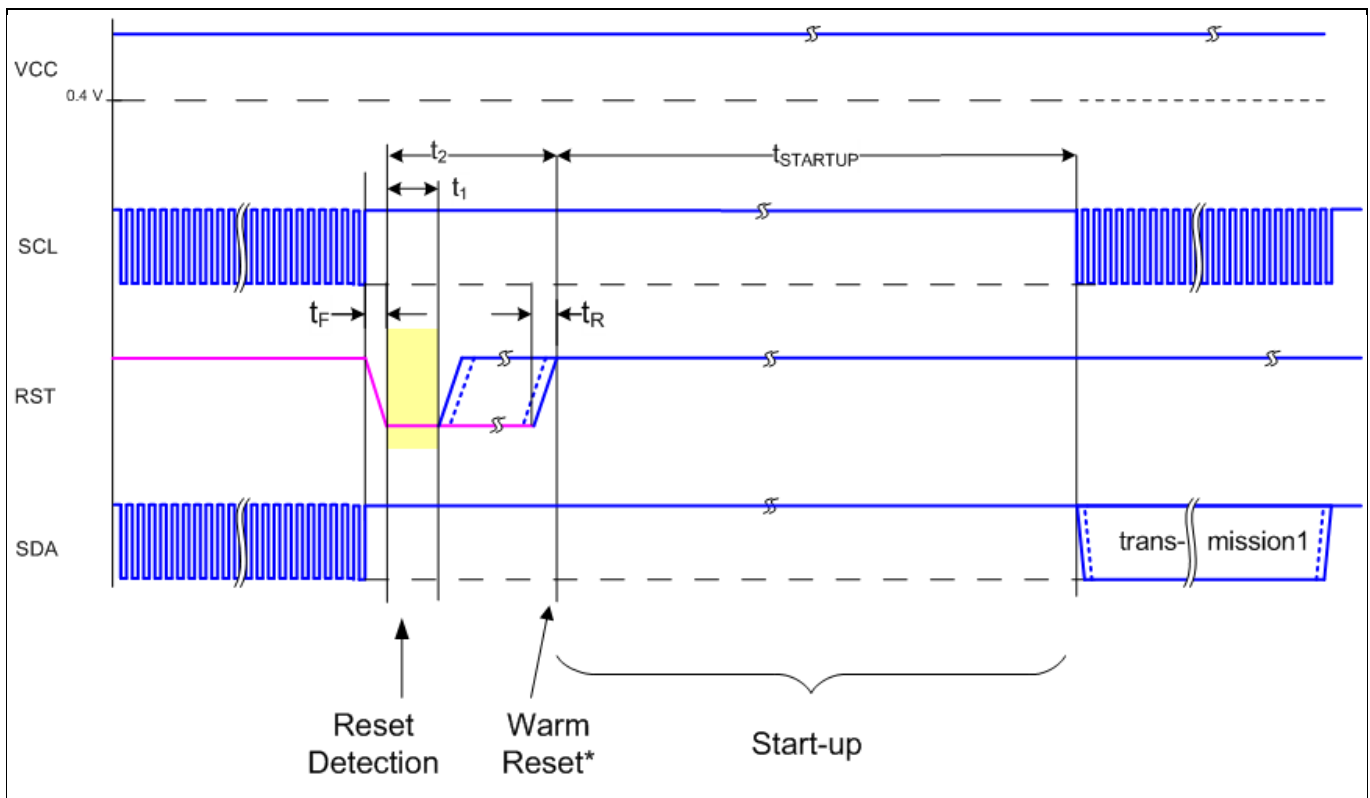

Figure 9 Startup of I2C Interface for Warm Resets

Note: If NVM programming was requested prior to the reset, $t_{STARTUP}$ will be extended from a typical value of 15 ms to a maximum of 20 ms.

OPTIGA™ Trust Charge

Technical Data

Table 12 Startup of I2C Interface for Warm Resets¹

Parameter	Symbol	Values			Unit	Note or Test Condition
		Min.	Typ.	Max.		
Startup time	t_{STARTUP}	15			ms	
Rise time	t_{R}			1	μs	From 10% to 90% of signal amplitude
Fall time	t_{F}			1	μs	From 10% to 90% of signal amplitude
Reset detection	t_1	10			μs	
Reset low		10		2500	μs	

1) Reset triggered by software (without power off/on cycle)

OPTIGA™ Trust Charge

Connecting to Host

6 Connecting to Host

6.1 OPTIGA™ Trust Charge Host Software Architecture

The OPTIGA™ Trust Charge Host Library layers were explained in System Block Diagram [Figure 1](#). In following sections, we will cover how to communicate with OPTIGA™ Trust Charge using I2C.

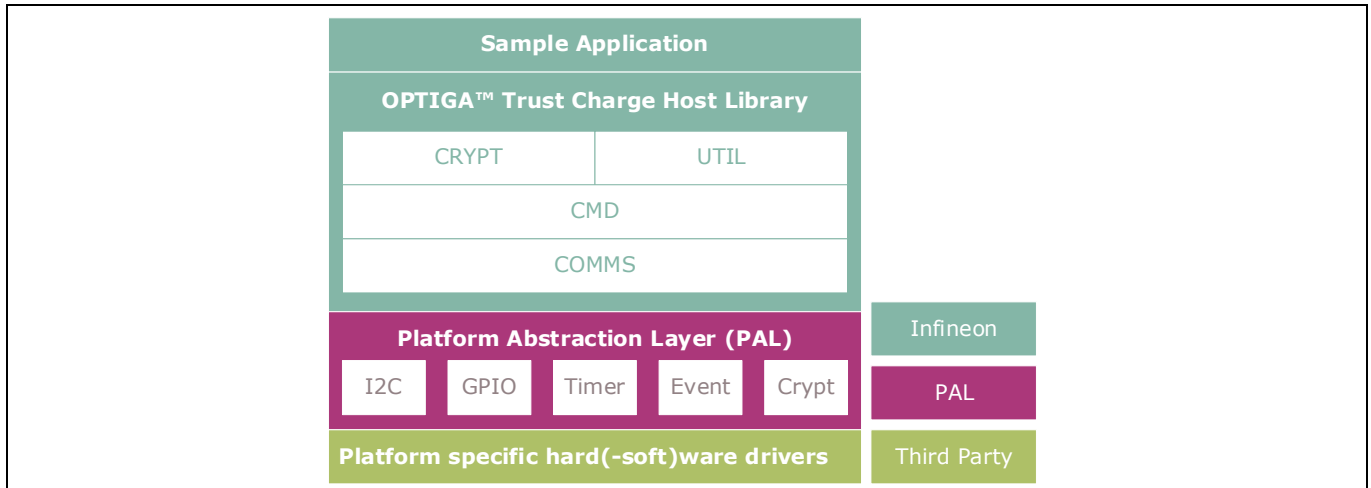

Figure 10 OPTIGA™ Trust Charge Host Software Architecture

6.2 Release Package Folder Structure

The following figure shows the release package structure when OPTIGA™ Trust Charge is installed/extracted on PC.

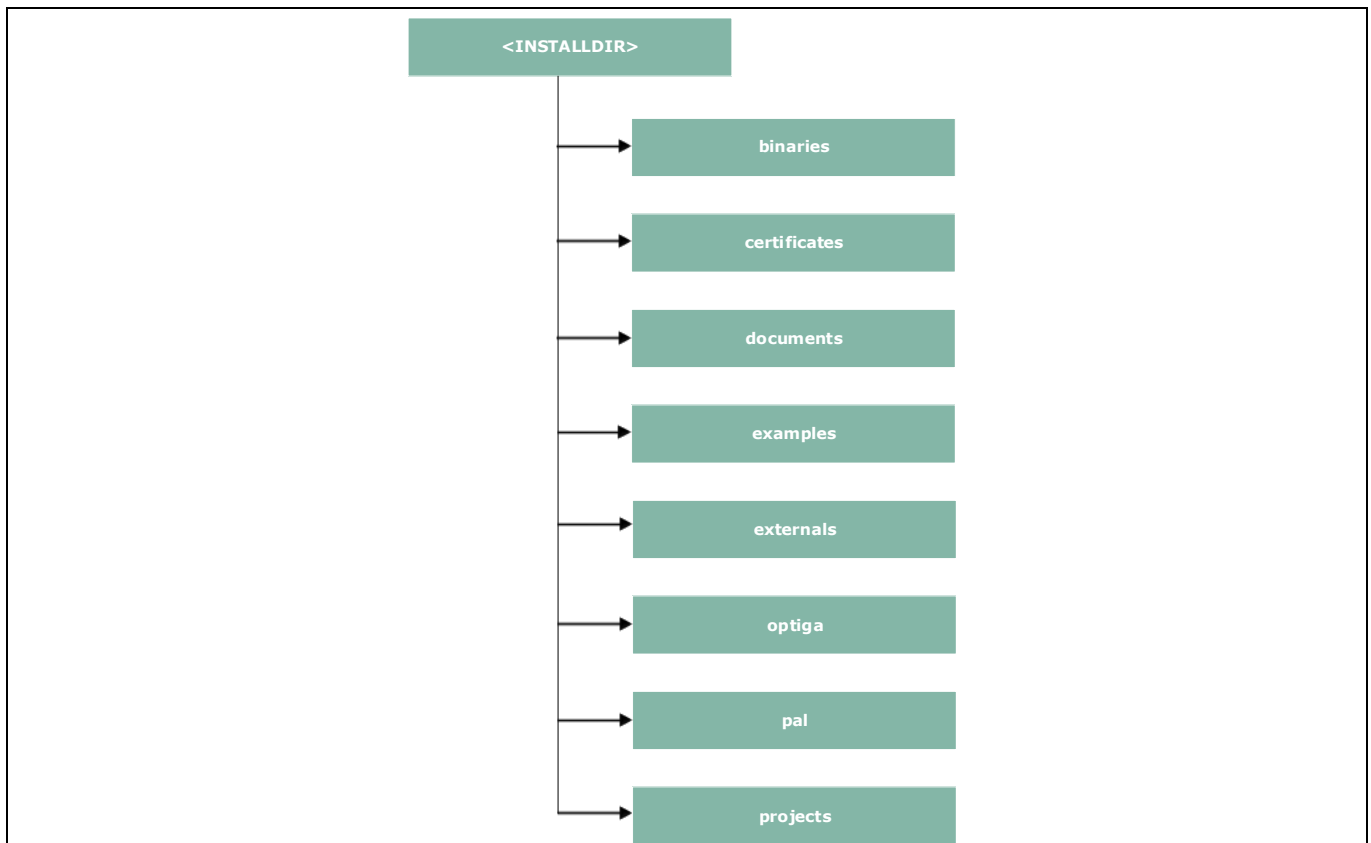

Figure 11 Release Package Folder Structure

<INSTALLDIR> is the root directory to which the release package contents are extracted. The following section explains the contents of each subdirectory under installed directory:

3. binaries

This directory contains binaries for OPTIGA™ Trust Charge sample application.

4. certificates

This directory contains OPTIGA™ Trust Charge certificates.

5. documents

This directory contains all relevant OPTIGA™ Trust Charge documentation.

6. examples

This directory contains example usecases for Toolbox features and a tool for generation of manifest for secure data object feature.

7. externals

This directory contains mbedtls software crypto libraries.

8. optiga

This directory contains OPTIGA™ Trust Charge libraries.

9. pal

This directory contains PAL for development kit and for mbedtls and wolfssl software crypto libraries.

10. projects

This directory contains development kit sample project in DAVE™ workspace.

Further the following figure elaborates the OPTIGA™ Trust Charge Host Software folder structure.

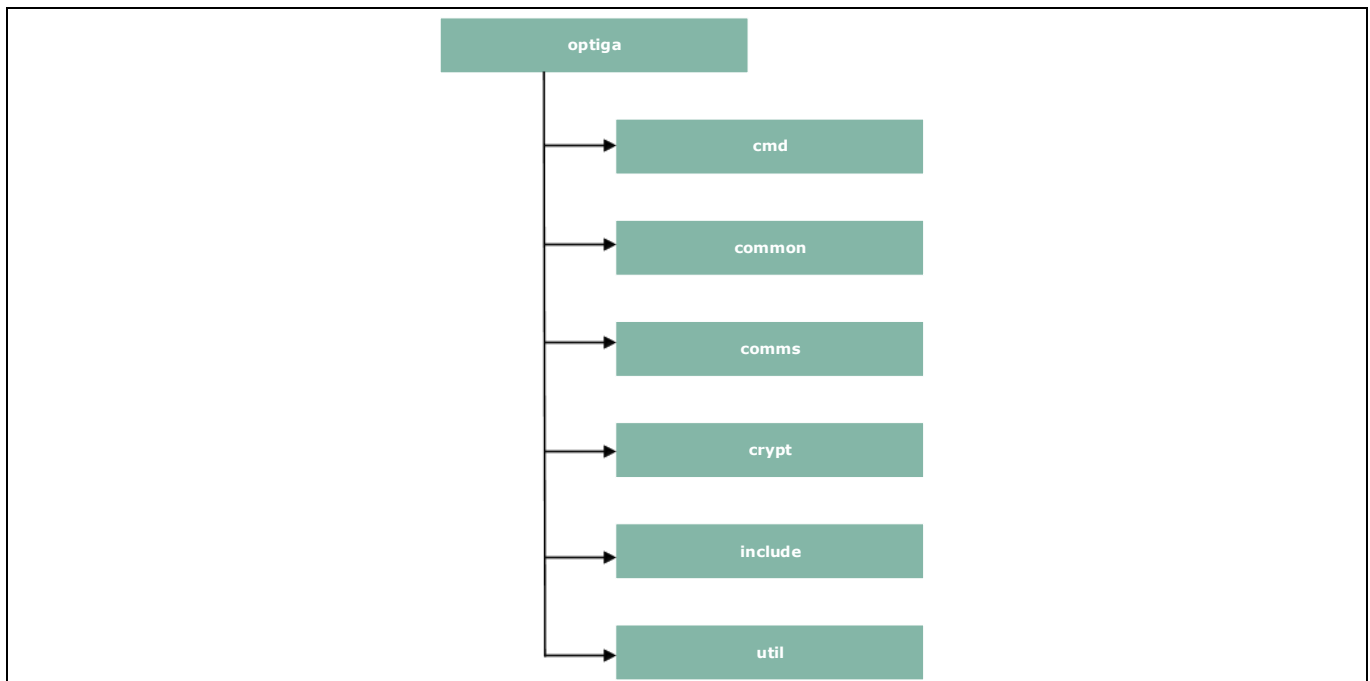

Figure 12 Host Source Folder Structure

1. cmd – This folder contains sources for all OPTIGA™ Trust Charge commands
2. common – This folder contains the common functions used across all the modules
3. comms – This folder contains the driver to communicate with OPTIGA™ Trust Charge
4. crypt – This folder contains sources for cryptographic functionalities
5. include – This folder contains header files for all OPTIGA™ Trust Charge Host Software
6. util – This folder contains utility functions e.g. read/write and open/close application

6.3 Porting Notes

The implementation of Platform Abstraction Layer (PAL) needs to be updated in order to migrate to a new target platform.

The PAL reference code for the XMC4700 IoT connectivity kit is provided as part of package which can be used. The implementation can be found in “<INSTALLDIR>/pal/xmc4700” and the header files are available in “<INSTALLDIR>/optiga/include” with the required APIs used by upper layers. The header files are platform agnostic and would not require any changes. The low level drivers used by PAL for XMC4700 are configured and generated using DAVE™.

6.4 Communication with OPTIGA™ Trust Charge

The hardware/platform resource configuration with respect to I2C master and GPIOs (Vdd and Reset) are to be updated in *pal_ifx_i2c_config.c*. These configurations are used by the IFX I2C implementation to communicate with OPTIGA™ Trust Charge.

1. Update I2C master platform specific context[e.g. (void*)&i2c_master_0]

```

001      /**
002      * \brief PAL I2C configuration for OPTIGA
003      */
004      pal_i2c_t optiga_pal_i2c_context_0 =
005      {
006          // Pointer to I2C master platform specific context
  
```

OPTIGA™ Trust Charge

Connecting to Host

```

006         (void*)&i2c_master_0,
007         /// Slave address
008         0x30,
009         /// Upper layer context
010         NULL,
011         /// Callback event handler
012         NULL
013     };

```

2. Update platform specific context for GPIOs (Vdd and Reset)

```

001     /**
002     * \brief Vdd pin configuration for OPTIGA
003     */
004     pal_gpio_t optiga_vdd_0 =
005     {
006         // Platform specific GPIO context for the pin used to toggle Vdd
007         (void*)&vdd_pin
008     };
009
010     /**
011     * \brief Reset pin configuration for OPTIGA
012     */
013     pal_gpio_t optiga_reset_0 =
014     {
015         // Platform specific GPIO context for the pin used to toggle Reset
016         (void*)&reset_pin
017     };

```

3. Update PAL I2C APIs [[pal_i2c.c](#)] to communicate with OPTIGA™ Trust Charge

The `pal_i2c` is expected to provide the APIs for I2C driver initialization, de-initialization, read, write and set bitrate kind of operations

- a) [pal_i2c_init](#)
- b) [pal_i2c_deinit](#)
- c) [pal_i2c_read](#)
- d) [pal_i2c_write](#)
- e) [pal_i2c_set_bitrate](#)

A few target platforms, the I2C master driver initialization ([pal_i2c_init](#)) is done during the platform start up. In such an environment, there is no need to implement [pal_i2c_init](#) and [pal_i2c_deinit](#) functions. Otherwise, these ([pal_i2c_init](#) & [pal_i2c_deinit](#)) functions must be implemented as per the upper layer expectations based on the need. The details of these expectations are available in the Host library API documentation (chm).

The reference implementation of PAL I2C based on development kit does not need to have the platform I2C driver initialization explicitly done as part of [pal_i2c_init](#) as it is taken care by the DAVE™ library initialization. Hence [pal_i2c_init](#) & [pal_i2c_deinit](#) are not implemented.

In addition to the above specified APIs, the PAL I2C must handle the events from the low level I2C driver and invoke the upper layer handlers registered with PAL I2C context for the respective transaction as shown in the below example.

```

001     //I2C driver callback function when the transmit is completed successfully
002     void i2c_master_end_of_transmit_callback(void)
003     {

```

OPTIGA™ Trust Charge

Connecting to Host

```

004         invoke_upper_layer_callback(gp_pal_i2c_current_ctx,
005                                     (uint8_t) PAL_I2C_EVENT_TX_SUCCESS);
006     }

```

In above example the I2C driver callback, when transmission is successful invokes the handler to inform the result.

4. Update PAL GPIO [[pal_gpio.c](#)] to power on and reset the OPTIGA™ Trust Charge
 - f) [pal_gpio_set_high](#)
 - g) [pal_gpio_set_low](#)
5. Update PAL Timer [[pal_os_timer.c](#)] to enable timer
 - h) [pal_os_timer_get_time_in_milliseconds](#)
 - i) [pal_os_timer_delay_in_milliseconds](#)
6. Update Event management for the asynchronous interactions for I2C [[pal_os_event.c](#)]
 - j) [pal_os_event_register_callback_oneshot](#)
 - k) [pal_os_event_trigger_registered_callback](#)

The [pal_os_event_register_callback_oneshot](#) function is expected to register the handler and context provided as part of input parameters and triggers the timer for the requested time. The `p_pal_os_event` is an event instance created using [pal_os_event_create](#).

```

001     void pal_os_event_register_callback_oneshot(
002                                     pal_os_event_t * p_pal_os_event,
003                                     register_callback callback,
004                                     void* callback_args,
005                                     uint32_t time_us)
006     {
007         p_pal_os_event->callback_registered = callback;
008         p_pal_os_event->callback_ctx = callback_args;
009
010         //lint --e{534} suppress "Return value is not required to be checked"
011         TIMER_SetTimeInterval(&scheduler_timer, (time_us*100));
012         TIMER_Start(&scheduler_timer);
013     }

```

The handler registered must be invoked once the timer has elapsed as shown in [pal_os_event_trigger_registered_callback](#). The [pal_os_event_trigger_registered_callback](#) is to be registered with event timer interrupt to get triggered when the timer expires. The `pal_os_event_0` is the instance in the `pal_os_event` used store the registered callback and context.

```

001     void pal_os_event_trigger_registered_callback(void)
002     {
003         register_callback callback;
004
005         TIMER_ClearEvent(&scheduler_timer);
006         //lint --e{534} suppress "Return value is not required to be checked"
007         TIMER_Stop(&scheduler_timer);
008         TIMER_Clear(&scheduler_timer);
009
010         if (pal_os_event_0.callback_registered)
011         {
012             callback = pal_os_event_0.callback_registered;

```

```

013         callback((void * )pal_os_event_0.callback_ctx);
014     }
015 }

```

6.5 Reference code for communicating with OPTIGA™ Trust Charge

```

001     static volatile uint32_t optiga_pal_event_status;
002     static void optiga_pal_i2c_event_handler(void* upper_layer_ctx,
003     uint8_t event);
004
005     pal_i2c_t optiga_pal_i2c_context_0 =
006     {
007         // Pointer to I2C master platform specific context
008         (void*)&i2c_master_0,
009         // Slave address
010         0x30,
011         // Upper layer context
012         NULL,
013         // Callback event handler
014         NULL,
015     };
016
017     // OPTIGA pal i2c event handler
018     static void optiga_pal_i2c_event_handler(void* upper_layer_ctx,
019     uint8_t event)
020     {
021         optiga_pal_event_status = event;
022     }

```

```

001     /* Function to verify I2C communication with OPTIGA */
002     pal_status_t test_optiga_communication(void)
003     {
004         pal_status_t pal_return_status;
005         uint8_t data_buffer[10] = {0x82};
006
007         // set callback handler for pal i2c
008         optiga_pal_i2c_context_0.upper_layer_event_handler =
009         optiga_pal_i2c_event_handler;
010
011         // Send 0x82 to read I2C_STATE from optiga
012         do
013         {
014             optiga_pal_event_status = PAL_I2C_EVENT_BUSY;
015             pal_return_status =
016                 pal_i2c_write(&optiga_pal_i2c_context_0,
017                             data_buffer,
018                             1);
019             if (PAL_STATUS_FAILURE == pal_return_status)
020             {
021                 // Pal I2C write failed due to I2C busy is in busy
022                 // state or low level driver failures
023                 break;
024             }
025
026             // Wait until writing to optiga is completed

```

```

027         } while (PAL_I2C_EVENT_SUCCESS != optiga_pal_event_status);
028
029
030         // Read the I2C_STATE from OPTIGA
031         do
032         {
033             optiga_pal_event_status = PAL_I2C_EVENT_BUSY;
034             pal_return_status =
035                 pal_i2c_read(&optiga_pal_i2c_context_0 ,
036                             data_buffer ,
037                             4);
038             // Pal I2C read failed due to I2C busy is in busy
039             // state or low level driver failures
040             if (PAL_STATUS_FAILURE == pal_return_status)
041             {
042                 break;
043             }
044             // Wait until reading from optiga is completed
045         } while (PAL_I2C_EVENT_SUCCESS != optiga_pal_event_status);
046
047         return pal_return_status;
048     }
049
050     /* Main Function */
051     int32_t main(void)
052     {
053         DAVE_STATUS_t status;
054         pal_status_t pal_return_status;
055
056         // Initialisation of DAVE Apps
057         status = DAVE_Init();
058
059         // Stop if DAVE init fails
060         if (DAVE_STATUS_FAILURE == status)
061         {
062             while (1U)
063             {;}
064         }
065         pal_return_status = test_optiga_communication();
066
067         return (int32_t)pal_return_status;
068     }

```

OPTIGA™ Trust Charge

OPTIGA™ Trust Charge External Interface

7 OPTIGA™ Trust Charge External Interface

7.1 Commands

This section provides short description of the commands exposed by the OPTIGA™ Trust Charge security chip and mapping of these commands w.r.t Use Cases.

Table 13 Command table

Command Name	Description
OpenApplication	Command to launch an application
CloseApplication	Command to close/hibernate an application
GetDataObject	Command to get (read) a data object
SetDataObject	Command to set (write) a data object
SetObjectProtected	Command to set (write) data objects protected (integrity protection)
GetRandom	Command to generate a random stream
CalcHash	Command to calculate a Hash
CalcSign	Command to calculate a signature
VerifySign	Command to verify a signature
GenKeyPair	Command to generate public/private key pairs

Table 14 Mapping of commands with Use cases

Use Case	OPTIGA™ Trust Charge commands used
Charge Authentication request	GetRandom, CalcHash, VerifySign
Charge Authentication response	CalcHash, CalcSign
Datastore (user memory ~ 10kB)	GetDataObject and SetDataObject
Secure Firmware Update	VerifySign
Secure update of Trust Anchors on Security Chip	SetObjectProtected command

7.2 Crypto Performance

The performance metrics for various schemes are provided by the [Table 15](#) below. If not particularly mentioned, the performance is measured @ OPTIGA™ Trust Charge I/O interface with:

- I2C FM (400KHz)
- Without power limitation
- @ 25°C
- VCC = 3.3V
- ECDSA Signature scheme: ECDSA FIPS 186-3 without hashing
- Hash scheme: SHA256
- ECC Key size: 256 bits (NIST P-256)

OPTIGA™ Trust Charge

OPTIGA™ Trust Charge External Interface

Table 15 Crypto performance

Scheme	Algorithm	Performance in ms ¹	Performance with Shielded Connection in ms ¹	Notes
Calculate signature	ECDSA	~ 60	~ 65	Doesn't include message hashing before calling a toolbox function
Verify signature	ECDSA	~ 85	~ 90	
Key pair generation	ECC	~ 75	~ 80	Generate 256 bit ECC key pair
Hash calculation	SHA256	~ 5 Kbyte/s	~ 4.5 Kbyte/s	In blocks of 500 bytes

¹Minimum Execution of the entire sequence in milli seconds, except the External World timings

8 Security Monitor

The Security Monitor is a central component which enforces the security policy of the OPTIGA™ Trust Charge. It consumes security events sent by security aware parts of the OPTIGA™ Trust Charge embedded SW and takes actions accordingly as specified in Security Policy below.

8.1 Security Events

The events below actively influence the security monitor.

Table 16 Security Events

Event	Description
Private Key Use	This event occurs in case the internal services are going to use an OPTIGA™ Trust Charge hosted private key.
Suspect System Behavior	This event occurs in case the embedded software detects inconsistencies with the expected behavior of the system. Those inconsistencies might be redundant information which doesn't fit to their counterpart.

8.2 Security Monitor Policy

Security Monitor judges the notified security events regarding the number of occurrence over time and in case those violate the permitted usage profile of the system takes actions to throttle down the performance and thus the possible frequency of attacks.

The permitted usage profile is defined as:

1. t_{max} is set to 5 seconds ($\pm 5\%$)
2. A Suspect System Behavior event is never permitted and will cause setting the Security Event Counter (SEC) to its maximum (= 255).
3. One protected operation (refer to [Table 16](#)) events per t_{max} period.

In other words it must not allow more than one out of the protected operations per t_{max} period (worst case, ref to bullet 3. above). This condition must be stable, at least after 500 uninterrupted executions of protected operations.

For more information, please refer to Solution Reference Manual document available as part of the package.

9 RoHS Compliance

On January 27, 2003 the European Parliament and the council adopted the directives:

- 2002/95/EC on the Restriction of the use of certain Hazardous Substances in electrical and electronic equipment ("RoHS")
- 2002/96/EC on Waste Electrical and Electrical and Electronic Equipment ("WEEE")

Some of these restricted (lead) or recycling-relevant (brominated flame retardants) substances are currently found in the terminations (e.g. lead finish, bumps, balls) and substrate materials or mold compounds.

The European Union has finalized the Directives. It is the member states' task to convert these Directives into national laws. Most national laws are available, some member states have extended timelines for implementation. The laws arising from these Directives have come into force in 2006 or 2007.

The electro and electronic industry has to eliminate lead and other hazardous materials from their products. In addition, discussions are on-going with regard to the separate recycling of certain materials, e.g. plastic containing brominated flame retardants.

Infineon Technologies is fully committed to giving its customers maximum support in their efforts to convert to lead-free and halogen-free¹ products. For this reason, Infineon Technologies' "Green Products" are ROHS-compliant.

Since all hazardous substances have been removed, Infineon Technologies calls its lead-free and halogen-free semiconductor packages "green." Details on Infineon Technologies' definition and upper limits for the restricted materials can be found here.

The assembly process of our high-technology semiconductor chips is an integral part of our quality strategy. Accordingly, we will accurately evaluate and test alternative materials in order to replace lead and halogen so that we end up with the same or higher quality standards for our products.

The use of lead-free solders for board assembly results in higher process temperatures and increased requirements for the heat resistivity of semiconductor packages. This issue is addressed by Infineon Technologies by a new classification of the Moisture Sensitivity Level (MSL). In a first step the existing products have been classified according to the new requirements.



¹Any material used by Infineon Technologies is PBB and PBDE-free. Plastic containing brominated flame retardants, as mentioned in the WEEE directive, will be replaced if technically/economically beneficial.

10 Appendix A – Infineon I2C Protocol Registry Map

OPTIGA™ Trust Charge supports IFX I2C v2.01 and is implemented as I2C slave, which uses different address locations for status, control and data communication registers. These registers with description are outlined below in the following table.

Table 17 IFX I2C Registry Map Table

Register Address	Name	Size in Bytes	Description	Master Access
0x80	DATA	DATA_REG_LEN	This is the location where data shall be read from or written to the I2C slave	Read / Write
0x81	DATA_REG_LEN	2	This register holds the maximum data register (Addr 0x80) length. The allowed values are 0x0010 up to 0xFFFF. After writing the new data register length it becomes effective with the next I2C master access. However, in case the slave could not accept the new length it indicates its maximum possible length within this register. Therefore it is recommended to read the value back after writing it to be sure the I2C slave did accept the new value. Note: the value of MAX_PACKET_SIZE is derived from this value or vice versa (MAX_PACKET_SIZE= DATA_REG_LEN-5)	Read / Write
0x82	I2C_STATE	4	Bits 31:24 of this register provides the I2C state in regards to the supported features (e.g. clock stretching ...) and whether the device is busy executing a command and/or ready to return a response etc. Bits 15:0 defining the length of the response data block at the physical layer.	Read only
0x83	BASE_ADDR	2	This register holds the I2C base address as specified by Table 18 . Default value is 0x30. After writing a different address the new address become effective with the next I2C master access. In case the bit 15 is set in addition to the new address (bit 6:0) it becomes the new default address at reset (persistent storage).	Write only
0x84	MAX_SCL_FREQ	4	This register holds the maximum clock frequency in KHz supported by the I2C slave. The value gets adjusted to the register I2C_Mode setting. Fast Mode (Fm): The allowed values are 50 up to 400. Fast Mode (Fm+): The allowed values are 50 up to 1000.	Read
0x85	GUARD_TIME ¹	4	For details refer to Table 21	Read only
0x86	TRANS_TIMEOUT ¹	4	For details refer to Table 21	Read only

¹ In case the register returns 0xFFFFFFFF the register is not supported and the default values specified in Table 'List of protocol variations' shall be applied.

OPTIGA™ Trust Charge

Appendix A – Infineon I2C Protocol Registry Map

Register Address	Name	Size in Bytes	Description	Master Access
0x88	SOFT_RESET	2	Writing to this register will cause a device reset. This feature is optional	Write only
0x89	I2C_MODE	2	This register holds the current I2C Mode as defined by Table 19 . The default mode is SM & FM (011B).	Read / Write

Table 18 Definition of BASE_ADDR

Fields	Bits	Value	Description
DEF_ADDR	15	0	Volatile address setting by bit 6:0, lost after reset.
		1	Persistent address setting by bit 6:0, becoming default after reset.
BASE_ADDR	6:0	0x00-0x7F	I ² C base address specified by Table 17

15	14	13	12	11	10	9	8
DEF_ADDR	RFU						
7	6	5	4	3	2	1	0
RFU	BASE_ADDR						

15	14	13	12	11	10	9	8
DEF_MODE	RFU						
7	6	5	4	3	2	1	0
RFU					Mode		

Table 19 Definition of I2C_MODE

Fields	Bits	Value	Description
DEF_MODE	15	0	Volatile mode setting by bit 2:0, lost after reset.
		1	Persistent mode setting by bit 2:0, becoming default after reset. This bit is always read as 0.
MODE ²	2:0	001 010 011 100 other values	Sm Fm SM & Fm (fab out default) Fm+ not valid; writing will be ignored

¹ In case the register returns 0xFFFFFFFF the register and its functionality is not supported

² This mode defines the adherence of the bus signals to the electrical characteristics according standard I2C bus specification

OPTIGA™ Trust Charge

Appendix A – Infineon I2C Protocol Registry Map

31	30	29	28	27	26	25	24
BUSY	RESP_RDY	RFU		SOFT_RESET	CONT_READ	REP_START	CLK_STRETCHING
23	22	21	20	19	18	17	16
PRESENT_LAYER	RFU						
15-0							
Length of data block to be read							

Table 20 Definition of I2C_STATE

Field	Bit(s)	Value	Description
BUSY	31	0 1	Device is not busy Device is busy executing a command
RESP_RDY	30	0 1	Device is not ready to return a response Device is ready to return a response
SOFT_RESET	27	0 1	SOFT_RESET not supported SOFT_RESET supported
CONT_READ	26	0 1	Continue Read not supported Continue Read supported
REP_START	25	0 1	Repeated start not supported Repeated start supported
CLK_STRETCHING	24	0 1	Clock stretching not supported Clock stretching supported
PRESENT_LAYER	23	0 1	Presentation Layer not supported Presentation Layer supported

10.1 Infineon I2C Protocol Variations

To fit best to application specific requirements the protocol might be tailored by specifying a couple of parameters which is described in the following table.

Table 21 List of Protocol Variations

Parameter	Default Value	Description
MAX_PACKET_SIZE	0x110	Maximum packet size accepted by the receiver. The protocol limits this value to 0xFFFF, but there might be project specific requirements to reduce the transport buffers size for the sake of less RAM footprint in the communication stack. If shortened, it could be statically defined or negotiated at the physical layer.
WIN_SIZE	1	Window size of the sliding windows algorithm. The value could be 1 up to 2.
MAX_NET_CHAN	1	Maximum number of network channels. The value could be 1 up to 16. One indicates the OSI Layer 3 is not used and the CHAN field of the PCTR must be set to 0000.
CHAINING	TRUE	Chaining on the transport layer is supported (TRUE) or not (FALSE)
TRANS_TIMEOUT	10 ms	(Re) transmission timeout specifies the number of milliseconds to be elapsed until the transmitter considers a frame

OPTIGA™ Trust Charge

Appendix A – Infineon I2C Protocol Registry Map

Parameter	Default Value	Description
		<p>transmission is lost and retransmits the non-acknowledged frame. The Timer gets started as soon as the complete frame is transmitted. The value could be 1 up to 1000. However, the higher the number, the longer it takes to recover from a frame transmission error.</p> <p><i>Note: The acknowledge timeout on the receiver side must be shorter than the retransmission timeout to avoid unnecessary frame repetitions.</i></p>
TRANS_REPEAT	3	Number of transmissions to be repeated until the transmitter considers the connection is lost and starts a re-synchronization with the receiver. The value could be 1 up to 4.
BASE_ADDR	0x30	I2C (base) address. This address could be statically defined or dynamically negotiated by the physical layer.
MAX_SCL_FREQU	1000 kHz	Maximum SCL clock frequency in kHz.
GUARD_TIME	50 μ s	<p>Minimum time to be elapsed at the I2C master measured from read data (STOP condition) until the next write data (Start condition) is allowed to happen.</p> <p><i>Note 1: For two consecutive accesses on the same device GUARD_TIME re-specifies the value of t_{BUF} as specified by [I2Cbus].</i></p> <p><i>Note 2: Even if another I2C address is accessed in between GUARD_TIME has to be respected for two consecutive accesses on the same device.</i></p>
SOFT_RESET	1	Any write attempt to the SOFT_RESET register will trigger a warm reset (reset w/o power cycle). This register is optional and its presence is indicated by the I2C_STATE register's "SOFT_RESET" flag.
PRESENT_LAYER	1	This flag at the I2C_STATE register indicates the optional availability of the presentation layer, which is providing confidentiality and integrity protection of payloads (APDUs) transferred across the I2C interface. The presentation layer is used as part of Shielded Connection.

OPTIGA™ Trust Charge

Appendix B - OPTIGA™ Trust Charge Command/Response I2C Sample Logs

11 Appendix B - OPTIGA™ Trust Charge Command/Response I2C Sample Logs

The default I2C slave address for the OPTIGA™ Trust Charge is 0x30 [I2C_ADDR]. All the values in this section are specified in decimal form unless stated otherwise.

11.1 Sequence of commands to read Coprocessor UID from OPTIGA™ Trust Charge

Pre-requisites

1. Ensure that the security device is powered up
2. The OPTIGA™ Trust Charge will not acknowledge the slave address sent by a host if it is either busy or in idle state. Hence the host must retry or repeat the transaction until it is successful or timed out for 100 milliseconds (extreme case).
3. The specified guard time must be applied between each attempt of write / read operation by the Host I2C driver.
4. The log information for OPTIGA™ Trust Charge commands specified in below Tables contains the [IFX I2C] protocol information which comprises sequence numbers and checksum of the transactions.
 - a. A sequence of commands must be strict for the OPTIGA™ Trust Charge (e.g. OpenApplication followed by GetDataObject to read a Coprocessor UID)
 - b. A checksum in the data depends on the data received or sent via write/read operations. So any data change in the transaction is reflected in the check sum. Otherwise the write data transaction will not be accepted/acknowledged by the OPTIGA™ Trust Charge.
5. The logs specified below are without the presentation layer (used for the Shielded Connection) of [IFX I2C]

11.1.1 Check the status [I2C_STATE]

This is a very basic register read operation which ensures the behavior of the read/write operations of the local host I2C driver.

Table 22 Check I2C_STATE Register of OPTIGA™ Trust Charge

I2C_ADDR	Transaction Type	Data [values in hexadecimal]
30	Write [01 Bytes]	82
30	Read [04 Bytes]	08 80 00 00

11.1.2 Issue OpenApplication command

Before issuing any application specific command; e.g. read Coprocessor UID using GetDataObject, it is a must to send the OpenApplication command to initialize the application on the OPTIGA™ Trust Charge as shown below.

Table 23 OpenApplication on OPTIGA™ Trust Charge

I2C_ADDR	Transaction Type	Data [values in hexadecimal]
Step 1: Send OpenApplication command to initiate the application context on the OPTIGA™ Trust Charge		

12 Appendix C – Power Management

When operating, the power consumption of OPTIGA™ Trust Charge is limited to meet the requirements regarding the power limitation set by the Host. The power limitation is implemented by utilizing the current limitation feature of the underlying hardware device in steps of 1mA from 6mA to 15 mA with a precision of ±5%.

12.1 Hibernation

This maximizes power saving (zero power consumption¹), while the I2C bus stays connected. In this case OPTIGA™ Trust Charge saves the application context before power-off (switching off V_{CC}) and restores it after power-up. After power-up the application continues seamlessly from the state before hibernate.

12.2 Low Power Sleep Mode

The OPTIGA™ Trust Charge automatically enters a low-power mode after a configurable delay. Once it has entered Sleep mode, the OPTIGA™ Trust Charge resumes normal operation as soon as its address is detected on the I2C bus.

In case no command is sent to the OPTIGA™ Trust Charge it behaves as shown in Figure 13.

1. As soon as the OPTIGA™ Trust Charge is idle it starts to count down the “delay to sleep” time (t_{SDY}).
2. In case this time elapses the device enters the “go to sleep” procedure.
3. The “go to sleep” procedure waits until all idle tasks are finished (e.g. counting down the SEC). In case all idle tasks are finished and no command is pending, the OPTIGA™ Trust Charge enters sleep mode.

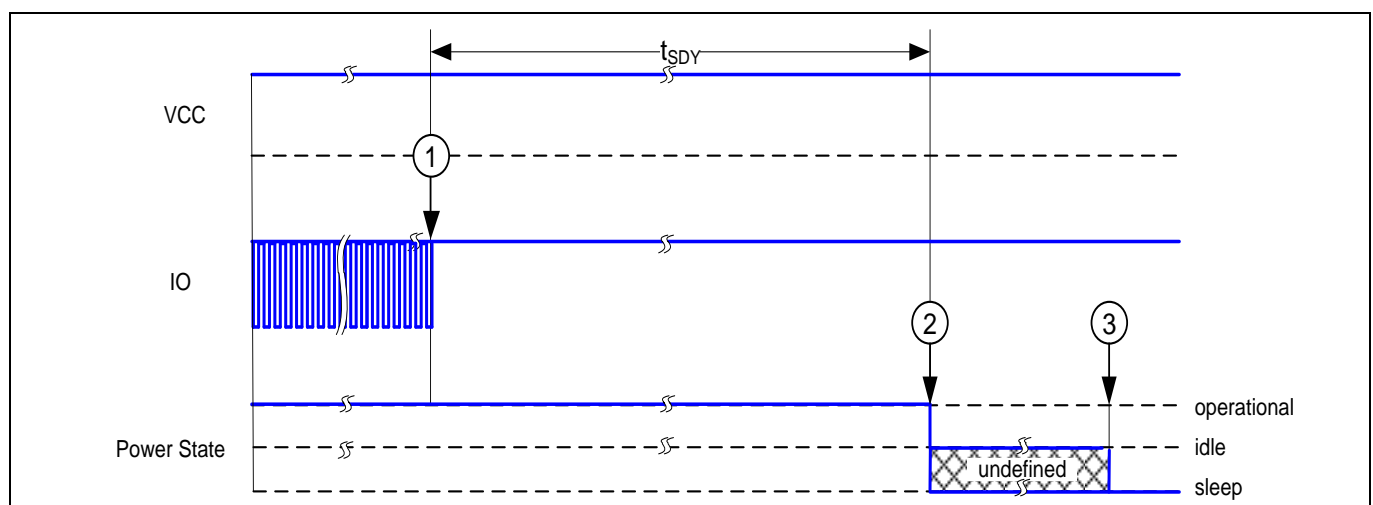

Figure 13 Go-to-Sleep Diagram

¹ Leakage current < 2.5µA

OPTIGA™ Trust Charge

Revision history

Revision history

Document version	Date of release	Description of changes
1.30	2020-07-27	Engineering Sample Release Version
1.00	2020-05-22	Initial Version
0.71	2020-03-19	Draft Version, Document security state updated and lccavg value corrected.
0.70	2020-01-27	Product renamed and image added
0.60	2019-12-06	Incorporated review comments
0.50	2019-12-05	Initial Version (Internal release)