

Three Phase Rectifier Bridge

$I_{dAV} = 58 \text{ A}$
 $V_{RRM} = 800-1800 \text{ V}$

V_{RSM} V	V_{RRM} V	Type
900	800	VUO 50-08NO3
1300	1200	VUO 50-12NO3
1500	1400	VUO 50-14NO3
1700	1600	VUO 50-16NO3
1900	1800	VUO 50-18NO3*

* delivery time on request

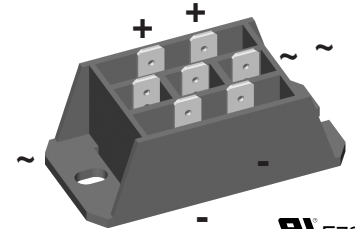
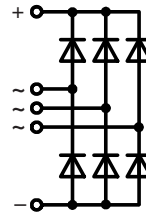

E72873

Symbol	Conditions	Maximum Ratings	
I_{dAV} ①	$T_C = 85^\circ\text{C}$, module	58	A
I_{dAVM} ①	module	75	A
I_{FSM}	$T_{VJ} = 45^\circ\text{C}$; $V_R = 0$	$t = 10 \text{ ms}$ (50 Hz), sine	500 A
		$t = 8.3 \text{ ms}$ (60 Hz), sine	525 A
I^2t	$T_{VJ} = T_{VJM}$; $V_R = 0$	$t = 10 \text{ ms}$ (50 Hz), sine	415 A
		$t = 8.3 \text{ ms}$ (60 Hz), sine	440 A
I^2t	$T_{VJ} = 45^\circ\text{C}$; $V_R = 0$	$t = 10 \text{ ms}$ (50 Hz), sine	1250 A ² s
		$t = 8.3 \text{ ms}$ (60 Hz), sine	1160 A ² s
T_{VJ}	$T_{VJ} = T_{VJM}$; $V_R = 0$	$t = 10 \text{ ms}$ (50 Hz), sine	860 A ² s
		$t = 8.3 \text{ ms}$ (60 Hz), sine	810 A ² s
T_{VJ}		-40...+125	°C
T_{VJM}		125	°C
T_{stg}		-40...+125	°C
V_{ISOL}	50/60 Hz, RMS $I_{ISOL} \leq 1 \text{ mA}$	$t = 1 \text{ min}$	3000 V~
		$t = 1 \text{ s}$	3600 V~
M_d	Mounting torque (M5) (10-32 UNF)		2-2.5 Nm
			18-22 lb.in.
Weight	typ.		50 g

Features

- Package with DCB ceramic base plate
- Isolation voltage 3600 V~
- Planar passivated chips
- Blocking voltage up to 1800 V
- low forward voltage drop
- ¼" fast-on terminals
- UL registered E 72873

Applications

- Supplies for DC power equipment
- Input rectifiers for PWM inverter
- Battery DC power supplies
- Rectifier for DC motors field current

Advantages

- Easy to mount with two screws
- Space and weight savings
- Improved temperature and power cycling

Dimensions in mm (1 mm = 0.0394")

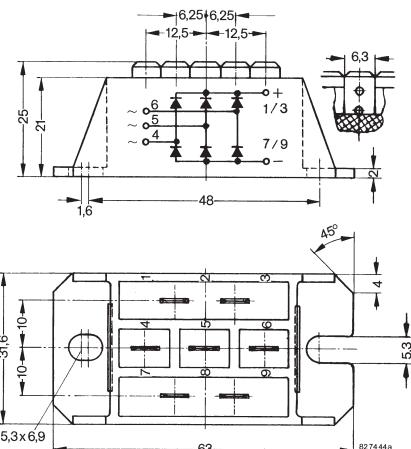

Symbol	Conditions	Characteristic Values	
I_R	$V_R = V_{RRM}$; $V_R = V_{RRM}$;	$T_{VJ} = 25^\circ\text{C}$	0.3 mA
		$T_{VJ} = T_{VJM}$	5 mA
V_F	$I_F = 150 \text{ A}$;	$T_{VJ} = 25^\circ\text{C}$	1.9 V
V_{T0}	For power-loss calculations only		0.9 V
r_T			6.0 mΩ
R_{thJC}	per diode, DC current		1.62 K/W
	per module		0.27 K/W
R_{thJH}	per diode, DC current		2.22 K/W
	per module		0.37 K/W
d_S	Creeping distance on surface	10	mm
d_A	Creepage distance in air	9.4	mm
a	Max. allowable acceleration	50	m/s ²

Data according to IEC 60747 and refer to a single diode unless otherwise stated.

① for resistive load at bridge output

Use output terminals in parallel connection!

IXYS reserves the right to change limits, test conditions and dimensions.

20080527a

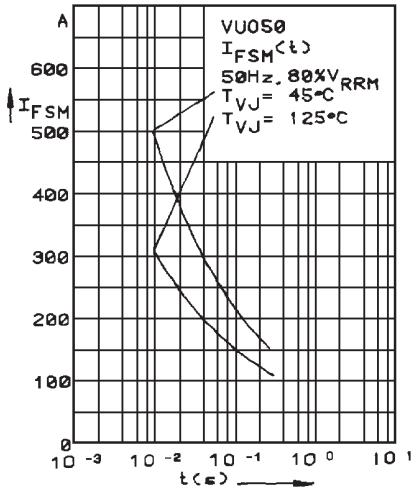

Fig. 1 Surge overload current
 I_{FSM} : Crest value, t : duration

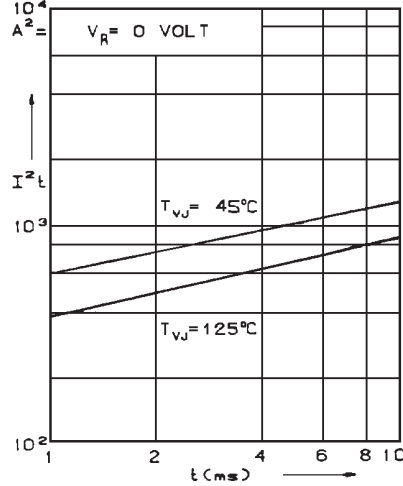

Fig. 2 I^2t versus time (1-10 ms)

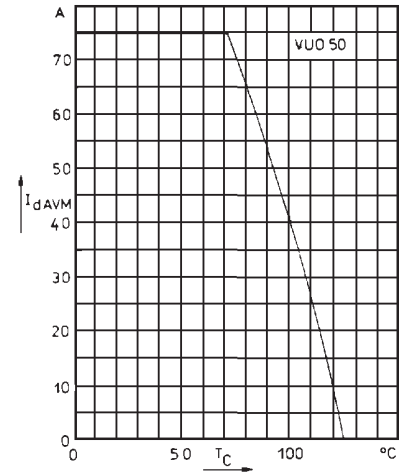

Fig. 3 Max. forward current at case temperature

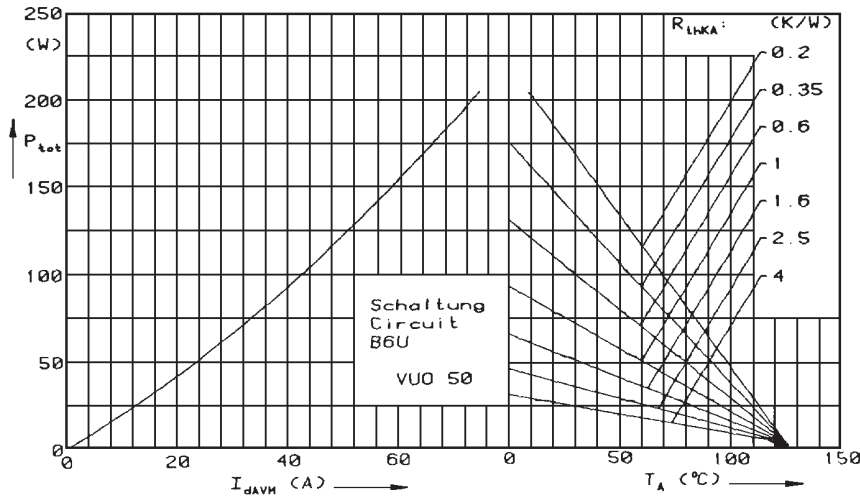

Fig. 4 Power dissipation versus forward current and ambient temperature

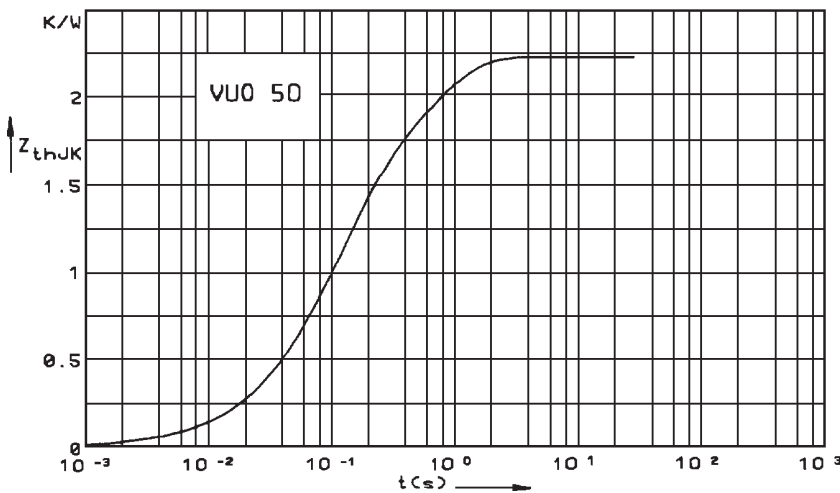

Fig. 5 Transient thermal impedance junction to heatsink per diode

Constants for Z_{thJK} calculation:

i	R_{thi} (K/W)	t_i (s)
1	1.21	0.1015
2	0.1339	0.1026
3	0.2763	0.4919