

# High Voltage Power MOSFETs

**IXTA/IXTP 3N120**  
**IXTA/IXTP 3N110**

N-Channel Enhancement Mode  
Avalanche Rated, High dv/dt

Preliminary Data Sheet

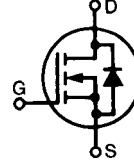

$V_{DSS}$	$I_{D25}$	$R_{DS(on)}$
1200 V	3 A	4.5 $\Omega$
1100 V	3 A	4.0 $\Omega$

Symbol	Test Conditions	Maximum Ratings		
$V_{DSS}$	$T_J = 25^\circ\text{C to } 150^\circ\text{C}$	3N120	1200	V
		3N110	1100	V
$V_{DGR}$	$T_J = 25^\circ\text{C to } 150^\circ\text{C}; R_{GS} = 1 \text{ M}\Omega$	3N120	1200	V
		3N110	1100	V
$V_{GS}$	Continuous		$\pm 20$	V
$V_{GSM}$	Transient		$\pm 30$	V
$I_{D25}$	$T_C = 25^\circ\text{C}$		3	A
$I_{DM}$	$T_C = 25^\circ\text{C}$ , pulse width limited by $T_{JM}$		12	A
$I_{AR}$	$T_C = 25^\circ\text{C}$		3	A
$E_{AR}$	$T_C = 25^\circ\text{C}$		20	mJ
$E_{AS}$			700	mJ
$dv/dt$	$I_S \leq I_{DM}$ , $di/dt \leq 100 \text{ A}/\mu\text{s}$ , $V_{DD} \leq V_{DSS}$ , $T_J \leq 150^\circ\text{C}$ , $R_G = 2 \Omega$		5	V/ns
$P_D$	$T_C = 25^\circ\text{C}$		150	W
$T_J$			-55 to +150	$^\circ\text{C}$
$T_{JM}$			150	$^\circ\text{C}$
$T_{stg}$			-55 to +150	$^\circ\text{C}$
$T_L$	1.6 mm (0.063 in) from case for 10 s		300	$^\circ\text{C}$
$M_d$	Mounting torque (TO-220)		1.13/10	Nm/lb.in.
<b>Weight</b>	TO-220		4	g
	TO-263		2	g

## TO-220 (IXTP)

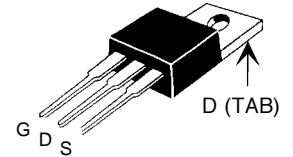

## TO-263 (IXTA)

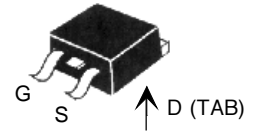

G = Gate      D = Drain  
S = Source    TAB = Drain

## Features

- International standard packages
- Low  $R_{DS(on)}$
- Rated for unclamped Inductive load Switching (UIS)
- Molding epoxies meet UL 94 V-0 flammability classification

## Advantages

- Easy to mount
- Space savings
- High power density

Symbol	Test Conditions	Characteristic Values ( $T_J = 25^\circ\text{C}$ , unless otherwise specified)		
		min.	typ.	max.
$V_{DSS}$	$V_{GS} = 0 \text{ V}$ , $I_D = 1 \text{ mA}$	3N120	1200	V
		3N110	1100	V
$V_{GS(th)}$	$V_{DS} = V_{GS}$ , $I_D = 250 \mu\text{A}$		2.5	4.5 V
$I_{GSS}$	$V_{GS} = \pm 20 V_{DC}$ , $V_{DS} = 0$			$\pm 100 \text{ nA}$
$I_{DSS}$	$V_{DS} = 0.8 V_{DSS}$ , $V_{GS} = 0 \text{ V}$	$T_J = 25^\circ\text{C}$		25 $\mu\text{A}$
		$T_J = 125^\circ\text{C}$		1 mA
$R_{DS(on)}$	$V_{GS} = 10 \text{ V}$ , $I_D = 0.5 I_{D25}$ Note 1	3N120		4.5 $\Omega$
		3N110		4.0 $\Omega$

Symbol	Test Conditions	Characteristic Values			
		(T <sub>J</sub> = 25°C, unless otherwise specified)			
		min.	typ.	max.	
<b>g<sub>fs</sub></b>	V <sub>DS</sub> = 10 V; I <sub>D</sub> = 0.5 • I <sub>D25</sub> , Note 1	1.5	2.2		S
<b>C<sub>iss</sub></b>	V <sub>GS</sub> = 0 V, V <sub>DS</sub> = 25 V, f = 1 MHz		1050	1300	pF
<b>C<sub>oss</sub></b>			100	125	pF
<b>C<sub>rss</sub></b>			25	50	pF
<b>t<sub>d(on)</sub></b>	V <sub>GS</sub> = 10 V, V <sub>DS</sub> = 0.5 • V <sub>DSS</sub> , I <sub>D</sub> = 0.5 • I <sub>D25</sub> R <sub>G</sub> = 4.7 Ω (External),		17		ns
<b>t<sub>r</sub></b>			15		ns
<b>t<sub>d(off)</sub></b>			32		ns
<b>t<sub>f</sub></b>			18		ns
<b>Q<sub>g(on)</sub></b>	V <sub>GS</sub> = 10 V, V <sub>DS</sub> = 0.5 • V <sub>DSS</sub> , I <sub>D</sub> = 0.5 • I <sub>D25</sub>		39		nC
<b>Q<sub>gs</sub></b>			9		nC
<b>Q<sub>gd</sub></b>			22		nC
<b>R<sub>thJC</sub></b>	(TO-220)			0.8	KW
<b>R<sub>thCK</sub></b>			0.25		KW

Symbol	Test Conditions	Characteristic Values			
		(T <sub>J</sub> = 25°C, unless otherwise specified)			
		min.	typ.	max.	
<b>I<sub>S</sub></b>	V <sub>GS</sub> = 0 V			3	A
<b>I<sub>SM</sub></b>	Repetitive; pulse width limited by T <sub>JM</sub>			12	A
<b>V<sub>SD</sub></b>	I <sub>F</sub> = I <sub>S</sub> , V <sub>GS</sub> = 0 V, Note 1			1.5	V
<b>t<sub>rr</sub></b>	I <sub>F</sub> = I <sub>S</sub> , -di/dt = 100 A/μs, V <sub>R</sub> = 100 V		700		ns

Notes: 1. Pulse test, t ≤ 300 μs, duty cycle d ≤ 2 %

### TO-220 (IXTP) Outline

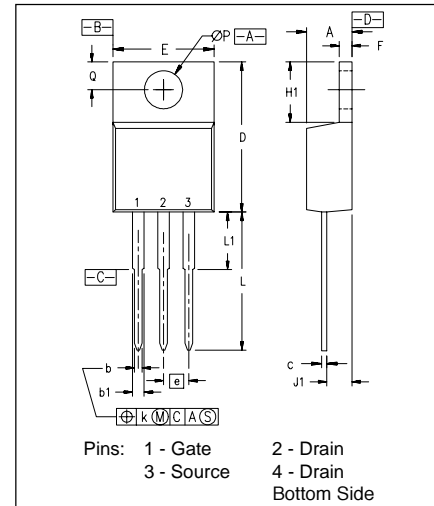

SYM	INCHES		MILLIMETERS	
	MIN	MAX	MIN	MAX
A	.170	.190	4.32	4.83
b	.025	.040	0.64	1.02
b1	.045	.065	1.15	1.65
c	.014	.022	0.35	0.56
D	.580	.630	14.73	16.00
E	.390	.420	9.91	10.66
e	.100 BSC		2.54 BSC	
F	.045	.055	1.14	1.40
H1	.230	.270	5.85	6.85
J1	.090	.110	2.29	2.79
k	0	.015	0	0.38
L	.500	.550	12.70	13.97
L1	.110	.230	2.79	5.84
ØP	.139	.161	3.53	4.08
Q	.100	.125	2.54	3.18

NOTE: This drawing will meet all dimensions requirement of JEDEC outline TO-220 AB.

### TO-263 (IXTA) Outline

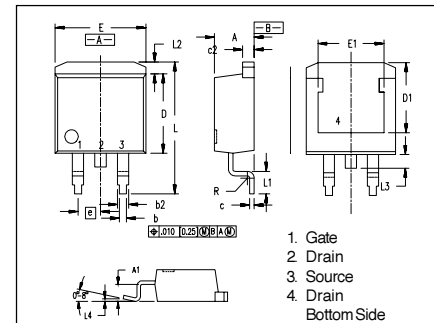

Dim.	Millimeter		Inches	
	Min.	Max.	Min.	Max.
A	4.06	4.83	.160	.190
A1	2.03	2.79	.080	.110
b	0.51	0.99	.020	.039
b2	1.14	1.40	.045	.055
c	0.46	0.74	.018	.029
c2	1.14	1.40	.045	.055
D	8.64	9.65	.340	.380
D1	7.11	8.13	.280	.320
E	9.65	10.29	.380	.405
E1	6.86	8.13	.270	.320
e	2.54	BSC	.100	BSC
L	14.61	15.88	.575	.625
L1	2.29	2.79	.090	.110
L2	1.02	1.40	.040	.055
L3	1.27	1.78	.050	.070
L4	0	0.38	0	.015
R	0.46	0.74	.018	.029

IXYS reserves the right to change limits, test conditions, and dimensions.

IXYS MOSFETS and IGBTs are covered by one or more of the following U.S. patents: 4,835,592 4,881,106 5,017,508 5,049,961 5,187,117 5,486,715  
4,850,072 4,931,844 5,034,796 5,063,307 5,237,481 5,381,025

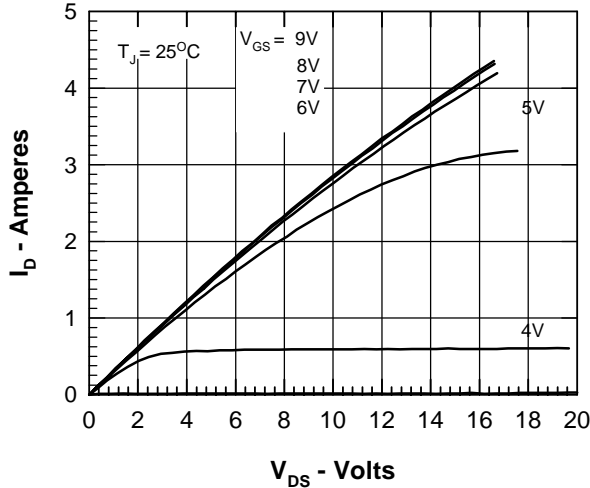

Fig.1 Output Characteristics @  $T_j = 25^\circ\text{C}$

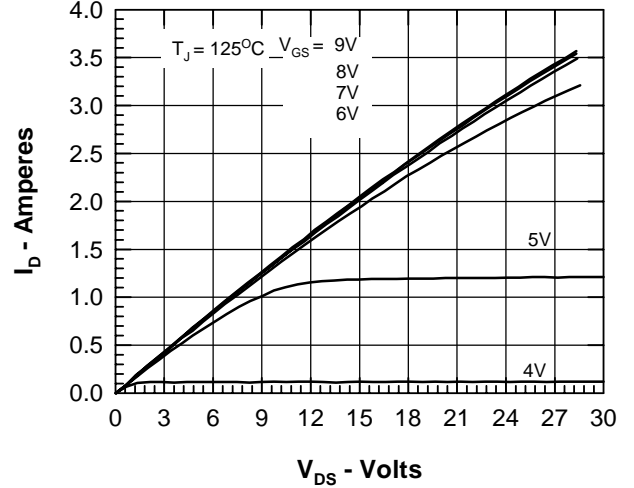

Fig. 2 Output Characteristics @  $T_j = 125^\circ\text{C}$

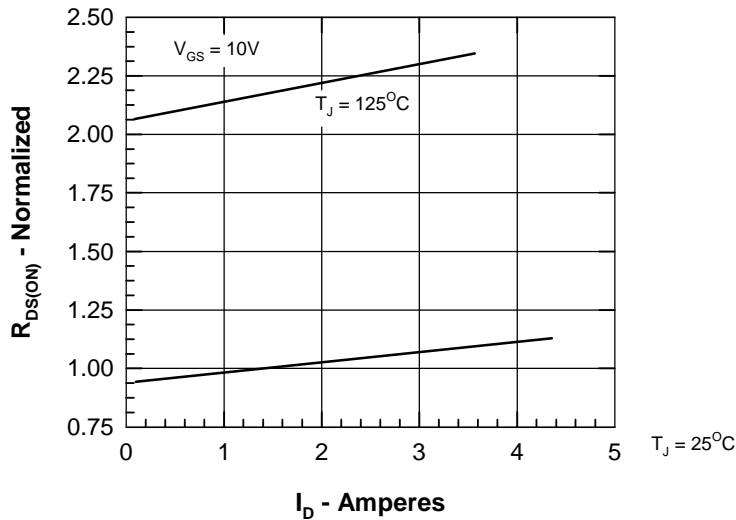

Fig. 3  $R_{DS(on)}$  vs. Drain Current

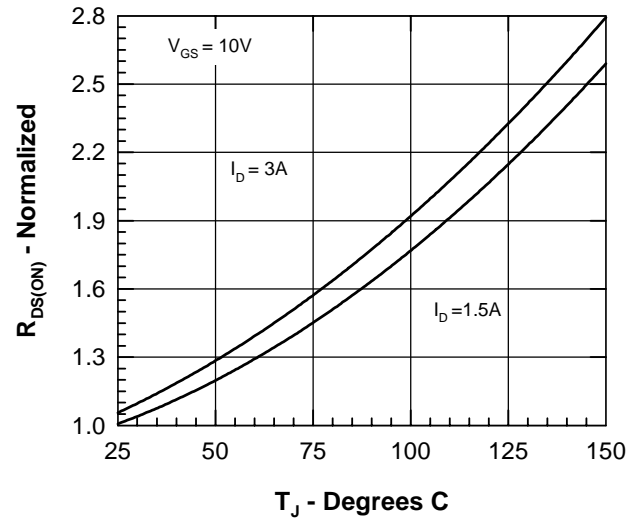

Fig. 4 Temperature Dependence of Drain to Source Resistance

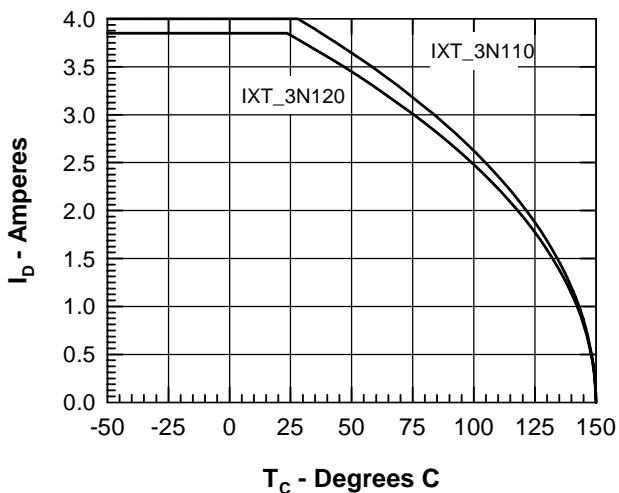

Fig. 5 Drain Current vs. Case Temperature

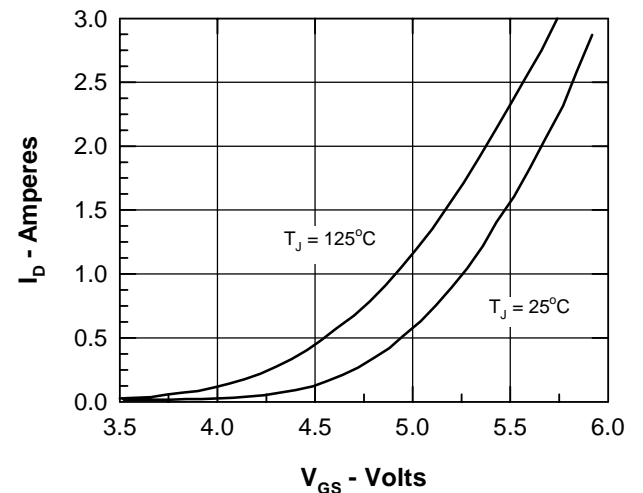

Fig. 6 Drain Current vs. Gate Source Voltage

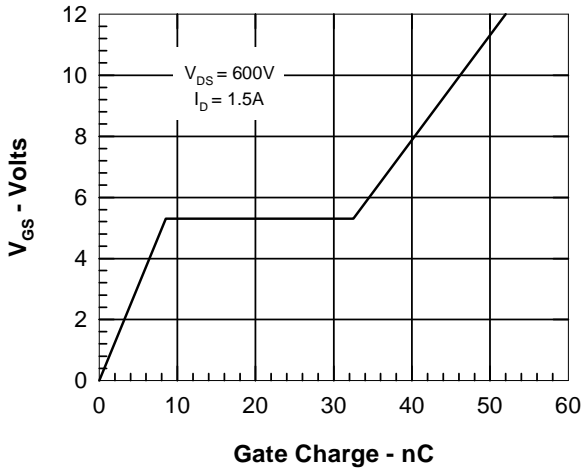

Fig. 7 Gate Charge Characteristic Curve

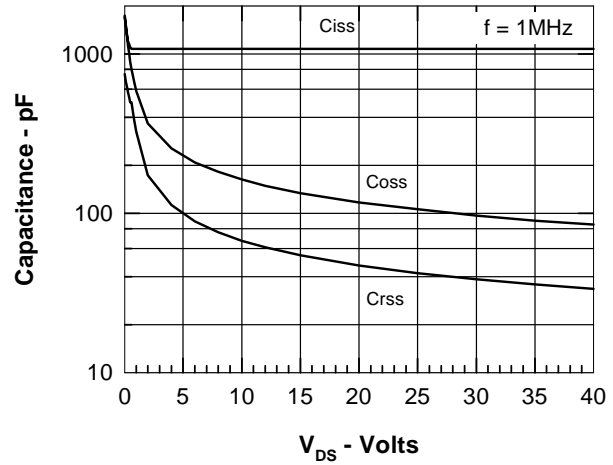

Fig. 8 Capacitance Curves

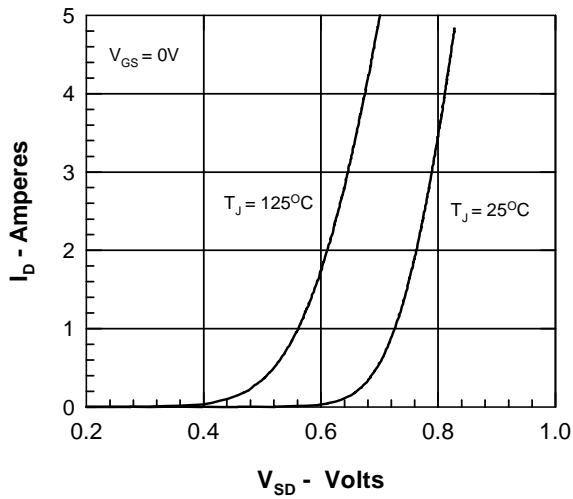

Fig. 9 Drain Current vs Drain to Source Voltage

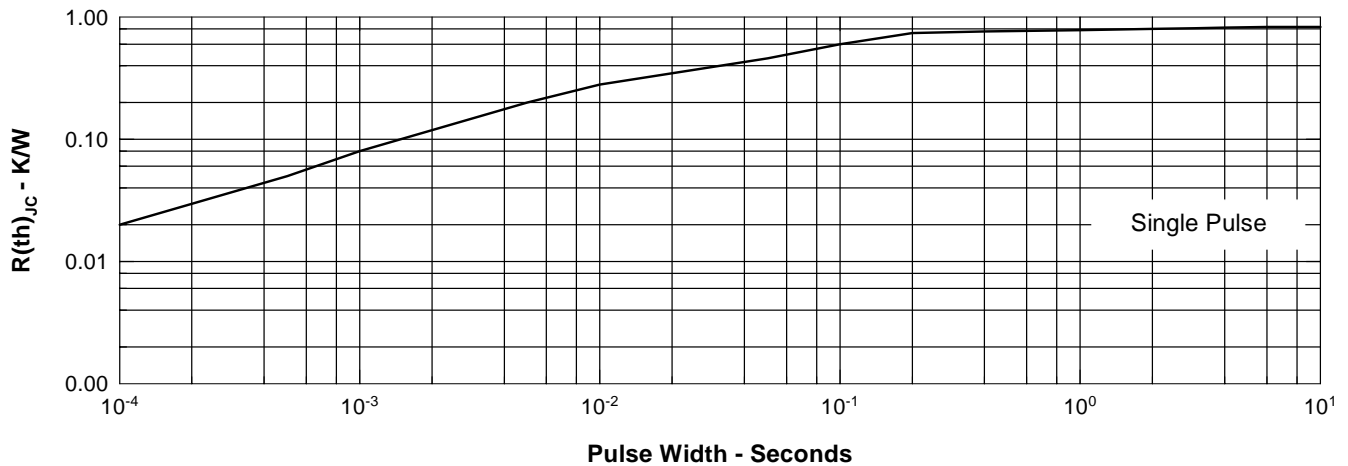

Fig.10 Transient Thermal Impedance

IXYS reserves the right to change limits, test conditions, and dimensions.

IXYS MOSFETS and IGBTs are covered by one or more of the following U.S. patents:

4,835,592	4,881,106	5,017,508	5,049,961	5,187,117	5,486,715
4,850,072	4,931,844	5,034,796	5,063,307	5,237,481	5,381,025