

# HiPerFET™ Power MOSFETs

IXFH/IXFT/IXFX14N100  
IXFH/IXFT/IXFX15N100

N-Channel Enhancement Mode  
High dv/dt, Low  $t_{rr}$ , HDMOS™ Family

$V_{DSS}$	$I_{D25}$	$R_{DS(on)}$
1000 V	14 A	0.75 $\Omega$
1000 V	15 A	0.70 $\Omega$

$t_{rr} \leq 200$  ns

Preliminary data sheet

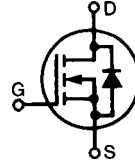

Symbol	Test Conditions	Maximum Ratings	
$V_{DSS}$	$T_J = 25^\circ\text{C}$ to $150^\circ\text{C}$	1000	V
$V_{DGR}$	$T_J = 25^\circ\text{C}$ to $150^\circ\text{C}$ ; $R_{GS} = 1$ M $\Omega$	1000	V
$V_{GS}$	Continuous	$\pm 20$	V
$V_{GSM}$	Transient	$\pm 30$	V
$I_{D25}$	$T_C = 25^\circ\text{C}$	14N100: 14 15N100: 15	A
$I_{DM}$	$T_C = 25^\circ\text{C}$ , pulse width limited by $T_{JM}$	14N100: 56 15N100: 60	A
$I_{AR}$	$T_C = 25^\circ\text{C}$	14N100: 14 15N100: 15	A
$E_{AR}$	$T_C = 25^\circ\text{C}$	45	mJ
dv/dt	$I_S \leq I_{DM}$ , $di/dt \leq 100$ A/ $\mu\text{s}$ , $V_{DD} \leq V_{DSS}$ , $T_J \leq 150^\circ\text{C}$ , $R_G = 2$ $\Omega$	5	V/ns
$P_D$	$T_C = 25^\circ\text{C}$	360	W
$T_J$		-55 ... +150	$^\circ\text{C}$
$T_{JM}$		150	$^\circ\text{C}$
$T_{stg}$		-55 ... +150	$^\circ\text{C}$
$T_L$	1.6 mm (0.062 in.) from case for 10 s	300	$^\circ\text{C}$
$M_d$	Mounting torque	1.13/10	Nm/lb.in.
Weight		6	g

TO-247 AD  
(IXFH)

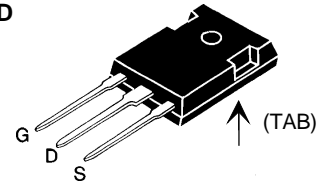

PLUS 247™  
(IXFX)

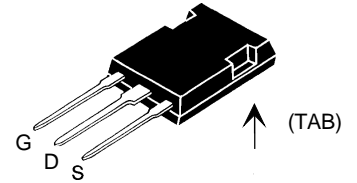

TO-268 (D3)  
(IXFT)

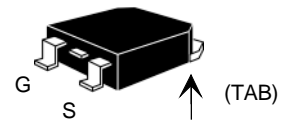

### Features

- International standard packages
- Low  $R_{DS(on)}$  HDMOS™ process
- Rugged polysilicon gate cell structure
- Unclamped Inductive Switching (UIS) rated
- Low package inductance
  - easy to drive and to protect
- Fast intrinsic Rectifier

### Applications

- DC-DC converters
- Battery chargers
- Switched-mode and resonant-mode power supplies
- DC choppers
- AC motor control
- Temperature and lighting controls

### Advantages

- Easy to mount with 1 screw (TO-247) (isolated mounting screw hole) or mounting clip or spring (PLUS 247™)
- High power surface mountable package
- High power density

Symbol	Test Conditions	Characteristic Values ( $T_J = 25^\circ\text{C}$ , unless otherwise specified)		
		min.	typ.	max.
$V_{DSS}$	$V_{GS} = 0$ V, $I_D = 1$ mA	1000		V
$V_{GS(th)}$	$V_{DS} = V_{GS}$ , $I_D = 4$ mA	2.5		V
$I_{GSS}$	$V_{GS} = \pm 20$ V <sub>DC</sub> , $V_{DS} = 0$			$\pm 100$ nA
$I_{DSS}$	$V_{DS} = 0.8 \cdot V_{DSS}$ , $T_J = 25^\circ\text{C}$ $V_{GS} = 0$ V, $T_J = 125^\circ\text{C}$			250 $\mu\text{A}$ 1 mA
$R_{DS(on)}$	$V_{GS} = 10$ V, $I_D = 0.5 \cdot I_{D25}$ Pulse test, $t \leq 300$ $\mu\text{s}$ , duty cycle $d \leq 2$ %	14N100: 0.75 15N100: 0.70		$\Omega$

Symbol	Test Conditions	Characteristic Values ( $T_J = 25^\circ\text{C}$ , unless otherwise specified)		
		min.	typ.	max.
$g_{fs}$	$V_{DS} = 10\text{ V}; I_D = 0.5 \cdot I_{D25}$ , pulse test	6	10	S
$C_{iss}$ $C_{oss}$ $C_{rss}$	$V_{GS} = 0\text{ V}, V_{DS} = 25\text{ V}, f = 1\text{ MHz}$		4500	pF
			430	pF
			150	pF
$t_{d(on)}$ $t_r$ $t_{d(off)}$ $t_f$	$V_{GS} = 10\text{ V}, V_{DS} = 0.5 \cdot V_{DSS}, I_D = 0.5 \cdot I_{D25}$ $R_G = 2\ \Omega$ (External),		27	ns
			30	ns
			120	ns
			30	ns
$Q_{g(on)}$ $Q_{gs}$ $Q_{gd}$	$V_{GS} = 10\text{ V}, V_{DS} = 0.5 \cdot V_{DSS}, I_D = 0.5 \cdot I_{D25}$		220	nC
			30	nC
			85	nC
$R_{thJC}$ $R_{thCK}$	(TO-247 Case Style)	0.25	0.35	K/W K/W

### TO-247 AD (IXFH) Outline

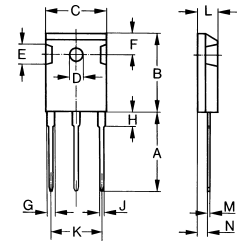

Dim.	Millimeter		Inches	
	Min.	Max.	Min.	Max.
A	19.81	20.32	0.780	0.800
B	20.80	21.46	0.819	0.845
C	15.75	16.26	0.610	0.640
D	3.55	3.65	0.140	0.144
E	4.32	5.49	0.170	0.216
F	5.4	6.2	0.212	0.244
G	1.65	2.13	0.065	0.084
H	-	4.5	-	0.177
J	1.0	1.4	0.040	0.055
K	10.8	11.0	0.426	0.433
L	4.7	5.3	0.185	0.209
M	0.4	0.8	0.016	0.031
N	1.5	2.49	0.087	0.102

Symbol	Test Conditions	Characteristic Values ( $T_J = 25^\circ\text{C}$ , unless otherwise specified)		
		min.	typ.	max.
$I_S$	$V_{GS} = 0\text{ V}$	14N100 15N100		14 A 15 A
$I_{SM}$	Repetitive; pulse width limited by $T_{JM}$	14N100 15N100		56 A 60 A
$V_{SD}$	$I_F = I_S, V_{GS} = 0\text{ V}$ , Pulse test, $t \leq 300\ \mu\text{s}$ , duty cycle $d \leq 2\%$			1.5 V
$t_{rr}$ $Q_{RM}$ $I_{RM}$	$I_F = I_S$ $-di/dt = 100\text{ A}/\mu\text{s}$ , $V_R = 100\text{ V}$	$T_J = 25^\circ\text{C}$ $T_J = 125^\circ\text{C}$ $T_J = 25^\circ\text{C}$ $T_J = 125^\circ\text{C}$ $T_J = 25^\circ\text{C}$ $T_J = 125^\circ\text{C}$		200 ns 350 ns
			1	$\mu\text{C}$
			2	$\mu\text{C}$
			10 15	A A

### PLUS247™ (IXFX) Outline

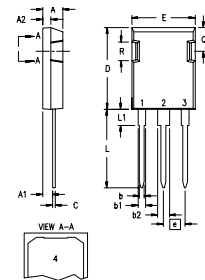

Dim.	Millimeter		Inches	
	Min.	Max.	Min.	Max.
A	4.83	5.21	.190	.205
A <sub>1</sub>	2.29	2.54	.090	.100
A <sub>2</sub>	1.91	2.16	.075	.085
b	1.14	1.40	.045	.055
b <sub>1</sub>	1.91	2.13	.075	.084
b <sub>2</sub>	2.92	3.12	.115	.123
C	0.61	0.80	.024	.031
D	20.80	21.34	.819	.840
E	15.75	16.13	.620	.635
e	5.45 BSC		.215 BSC	
L	19.81	20.32	.780	.800
L <sub>1</sub>	3.81	4.32	.150	.170
Q	5.59	6.20	.220	.244
R	4.32	4.83	.170	.190

### TO-268AA (D<sup>3</sup> PAK)

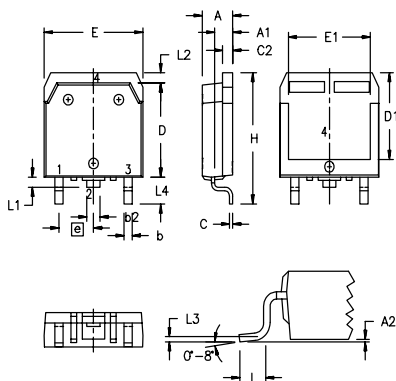

Dim.	Millimeter		Inches	
	Min.	Max.	Min.	Max.
A	4.9	5.1	.193	.201
A <sub>1</sub>	2.7	2.9	.106	.114
A <sub>2</sub>	.02	.25	.001	.010
b	1.15	1.45	.045	.057
b <sub>2</sub>	1.9	2.1	.75	.83
C	.4	.65	.016	.026
D	13.80	14.00	.543	.551
E	15.85	16.05	.624	.632
E <sub>1</sub>	13.3	13.6	.524	.535
e	5.45 BSC		.215 BSC	
H	18.70	19.10	.736	.752
L	2.40	2.70	.094	.106
L <sub>1</sub>	1.20	1.40	.047	.055
L <sub>2</sub>	1.00	1.15	.039	.045
L <sub>3</sub>	0.25 BSC		.010 BSC	
L <sub>4</sub>	3.80	4.10	.150	.161

### Min. Recommended Footprint

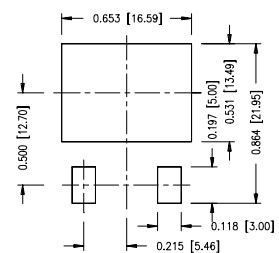

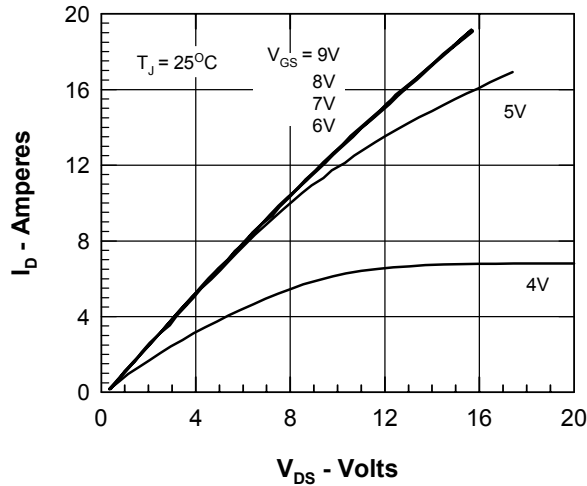

Fig.1 Output Characteristics

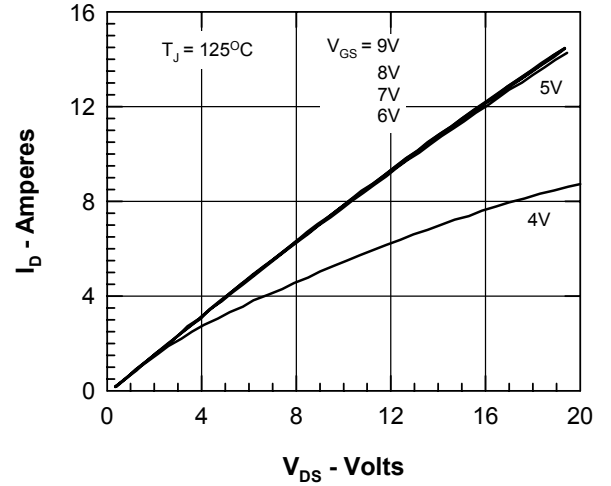

Fig.2 Output characteristics at elevated temperature

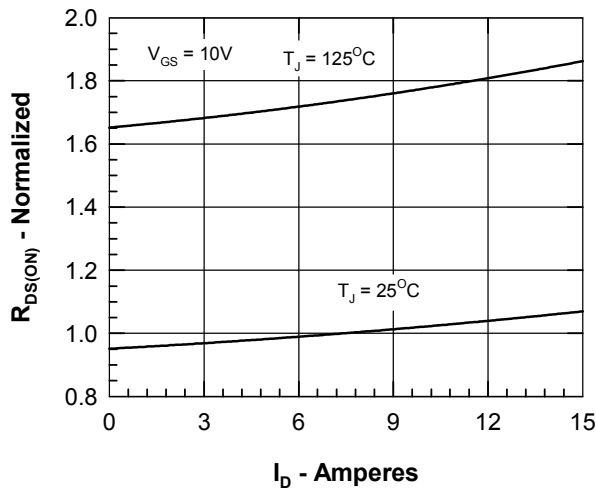
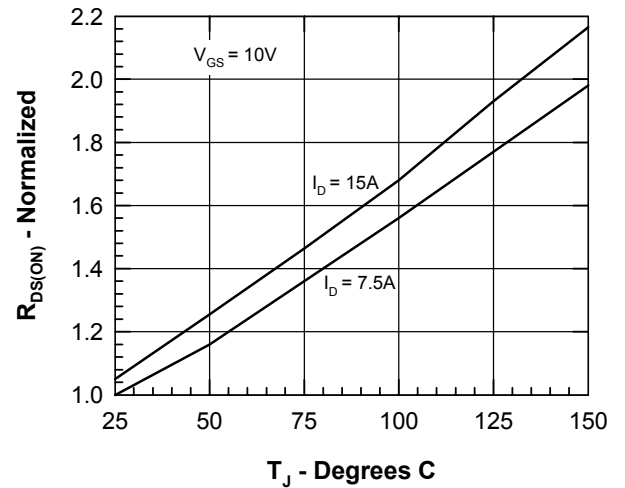

 Fig.3  $R_{DS(on)}$  vs. Drain Current

Fig.4 Temperature Dependence of Drain to Source Resistance

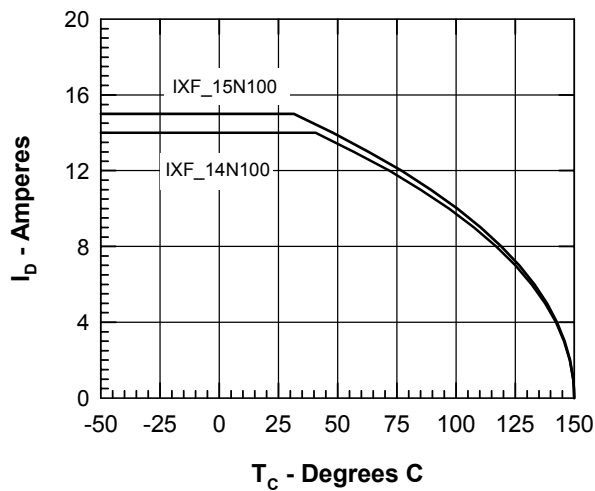

Fig.5 Drain Current vs. Case Temperature

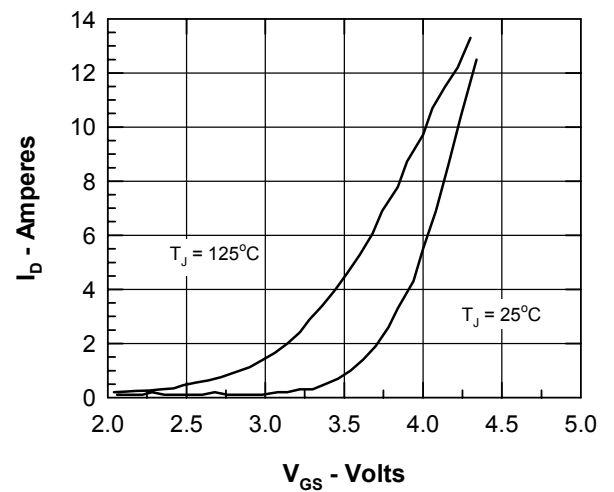

Fig.6 Input admittance

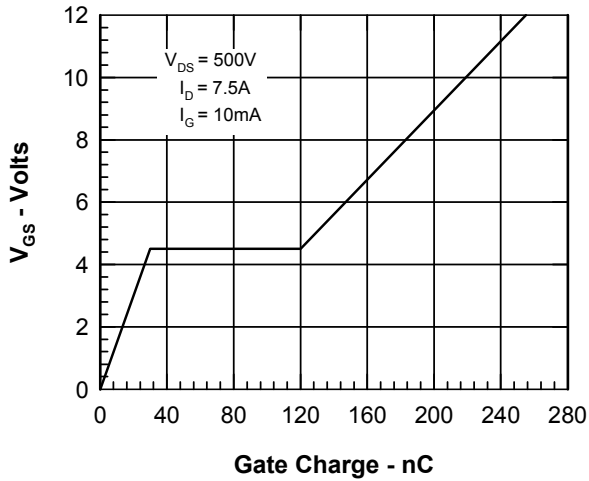

Fig.7 Gate Charge Characteristic Curve

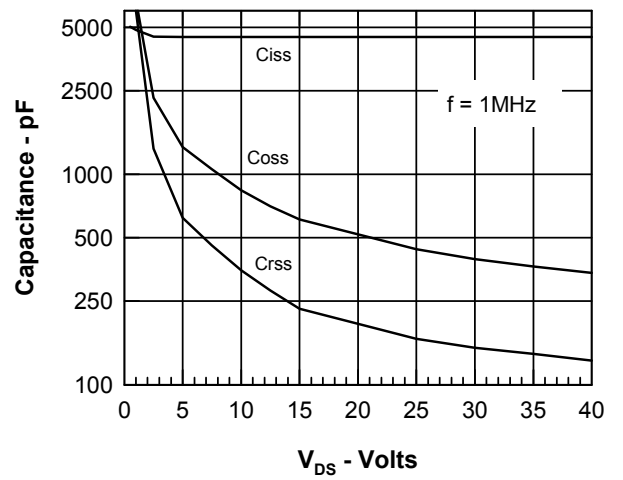

Fig.8 Capacitance Curves

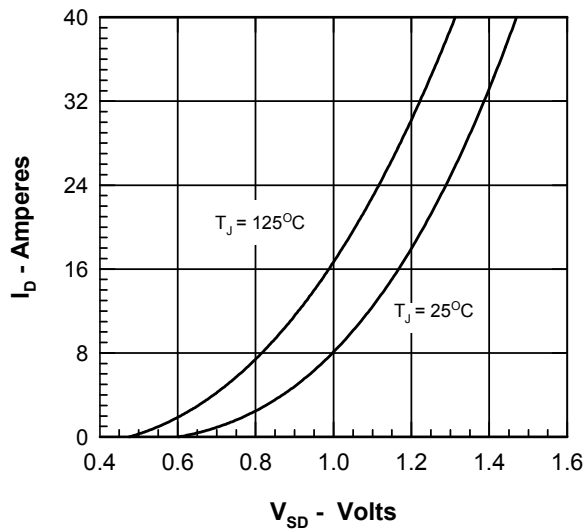

Fig.9 Source current vs Source drain voltage.

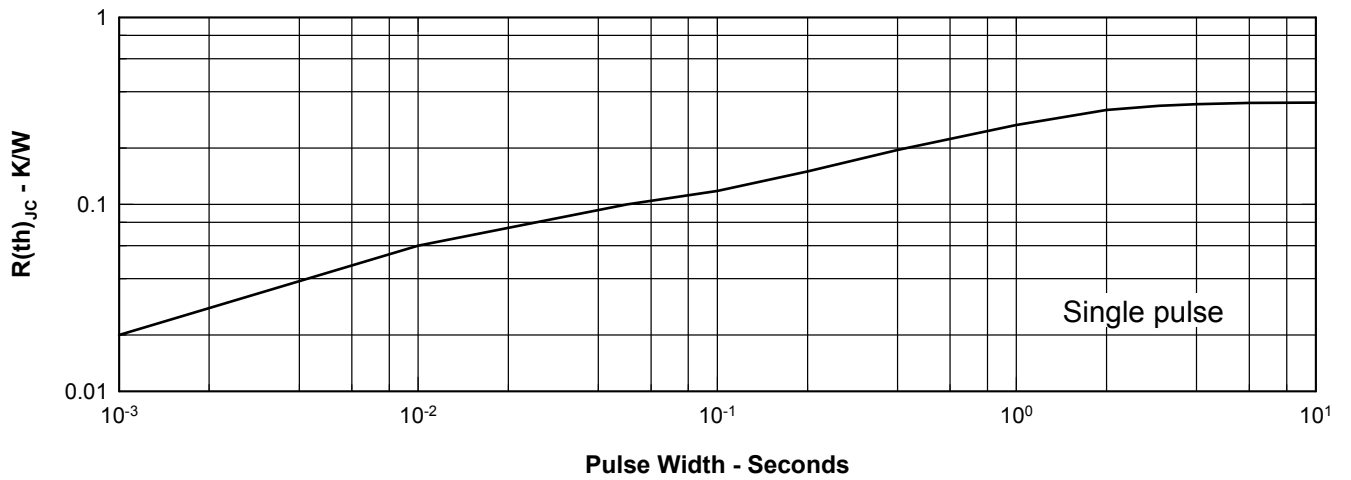

Fig.10 Transient Thermal Impedance