

5

4

3

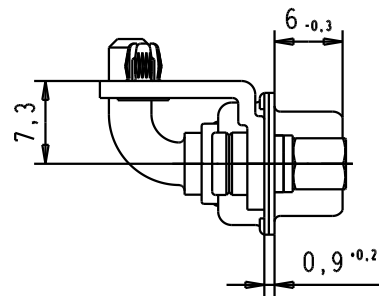
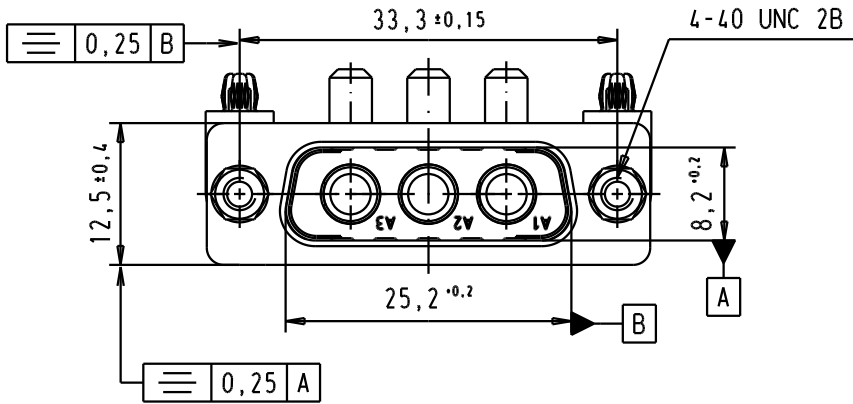

2

1

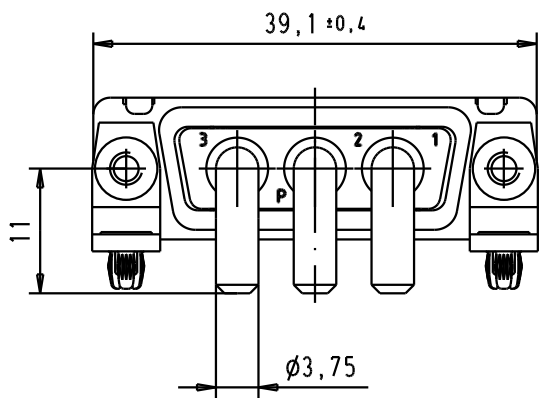
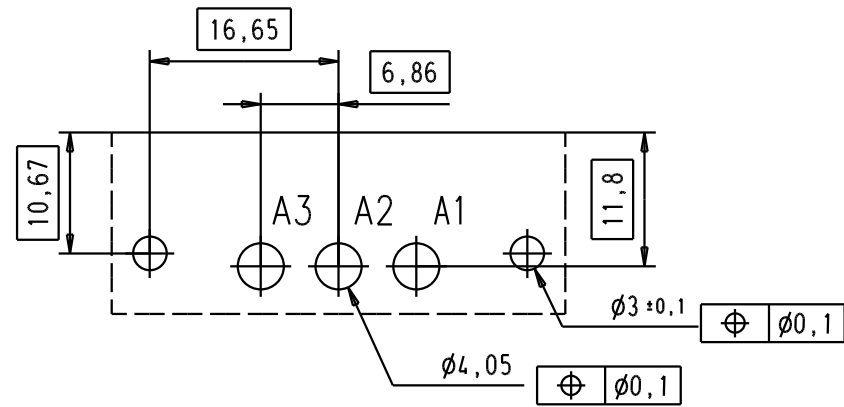
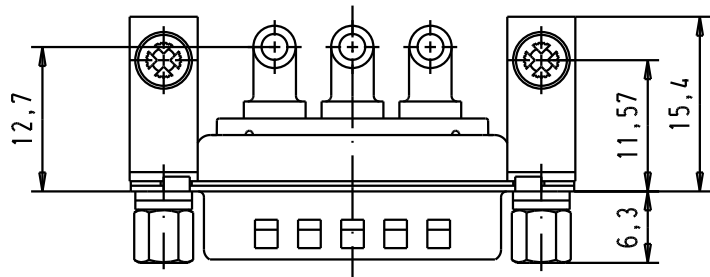

PCB lay out, component side,
PCB thickness 1,6 mm

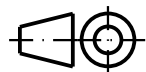

						 All Dim. in mm Orig. Size DIN A 4	D-sub, male, angled, 3W3 - 40 Amp, solder pins, tin plated shell with dimples, screw lock, nut and board lock	Maßstab/ Scale 1,5:1
			Det.	13/04/04	JH			
			Insp.					
			Stand.					
31886	13/04/04	JH	HARTING EURL F-95972 Paris				TB 09 69 200 9100	Blatt / Page 1 / 1
Mod.	Det.	Name					Sub.	