

## MPSH11

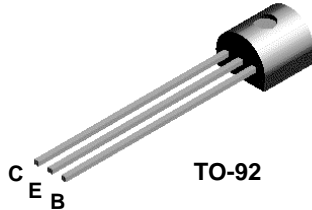

## MMBTH11

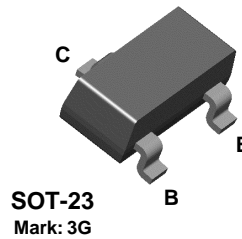

### NPN RF Transistor

This device is designed for common-emitter low noise amplifier and mixer applications with collector currents in the 100  $\mu$ A to 10 mA range to 300 MHz, and low frequency drift common-base VHF oscillator applications with high output levels for driving FET mixers. Sourced from Process 47.

#### Absolute Maximum Ratings\*

TA = 25°C unless otherwise noted

Symbol	Parameter	Value	Units
V <sub>CEO</sub>	Collector-Emitter Voltage	25	V
V <sub>CBO</sub>	Collector-Base Voltage	30	V
V <sub>EBO</sub>	Emitter-Base Voltage	3.0	V
I <sub>C</sub>	Collector Current - Continuous	50	mA
T <sub>J</sub> , T <sub>stg</sub>	Operating and Storage Junction Temperature Range	-55 to +150	°C

\*These ratings are limiting values above which the serviceability of any semiconductor device may be impaired.

#### NOTES:

- 1) These ratings are based on a maximum junction temperature of 150 degrees C.
- 2) These are steady state limits. The factory should be consulted on applications involving pulsed or low duty cycle operations.

#### Thermal Characteristics

TA = 25°C unless otherwise noted

Symbol	Characteristic	Max		Units
		MPSH11	*MMBTH11	
P <sub>D</sub>	Total Device Dissipation	350	225	mW
	Derate above 25°C	2.8	1.8	mW/°C
R <sub>θJC</sub>	Thermal Resistance, Junction to Case	125		°C/W
R <sub>θJA</sub>	Thermal Resistance, Junction to Ambient	357	556	°C/W

\*Device mounted on FR-4 PCB 1.6" X 1.6" X 0.06."

# NPN RF Transistor

(continued)

MPSH11 / MMBTH11

## Electrical Characteristics

TA = 25°C unless otherwise noted

Symbol	Parameter	Test Conditions	Min	Max	Units
<b>OFF CHARACTERISTICS</b>					
$V_{(BR)CEO}$	Collector-Emitter Sustaining Voltage*	$I_C = 1.0 \text{ mA}, I_B = 0$	25		V
$V_{(BR)CBO}$	Collector-Base Breakdown Voltage	$I_C = 100 \text{ } \mu\text{A}, I_E = 0$	30		V
$V_{(BR)EBO}$	Emitter-Base Breakdown Voltage	$I_E = 10 \text{ } \mu\text{A}, I_C = 0$	3.0		V
$I_{CBO}$	Collector Cutoff Current	$V_{CB} = 25 \text{ V}, I_E = 0$		100	nA
$I_{EBO}$	Emitter Cutoff Current	$V_{EB} = 2.0 \text{ V}, I_C = 0$		100	nA

## ON CHARACTERISTICS

$h_{FE}$	DC Current Gain	$I_C = 4.0 \text{ mA}, V_{CE} = 10 \text{ V}$	60		
$V_{CE(sat)}$	Collector-Emitter Saturation Voltage	$I_C = 4.0 \text{ mA}, I_B = 0.4 \text{ mA}$		0.5	V
$V_{BE(on)}$	Base-Emitter On Voltage	$I_C = 4.0 \text{ mA}, V_{CE} = 10 \text{ V}$		0.95	V

## SMALL SIGNAL CHARACTERISTICS

$f_T$	Current Gain - Bandwidth Product	$I_C = 4.0 \text{ mA}, V_{CE} = 10 \text{ V}, f = 100 \text{ MHz}$	650		MHz
$C_{cb}$	Collector-Base Capacitance	$V_{CB} = 10 \text{ V}, I_E = 0, f = 1.0 \text{ MHz}$		0.7	pF
$C_{rb}$	Common-Base Feedback Capacitance	$V_{CB} = 10 \text{ V}, I_E = 0, f = 1.0 \text{ MHz}$	0.6	0.9	pF
$r_{b\frac{1}{\beta}C}$	Collector Base Time Constant	$I_C = 4.0 \text{ mA}, V_{CB} = 10 \text{ V}, f = 31.8 \text{ MHz}$		9.0	pS

\*Pulse Test: Pulse Width  $\leq 300 \text{ } \mu\text{s}$ , Duty Cycle  $\leq 2.0\%$

## Typical Characteristics

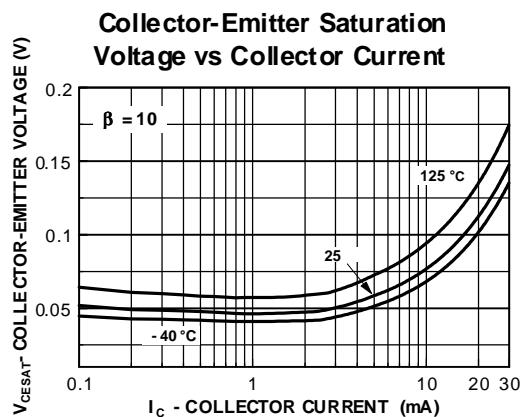
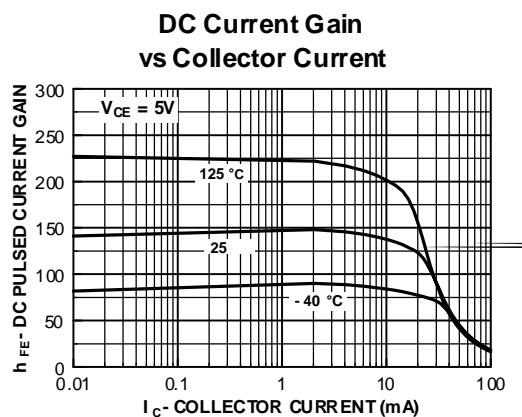

Typical Characteristics (continued)

Base-Emitter Saturation Voltage vs Collector Current

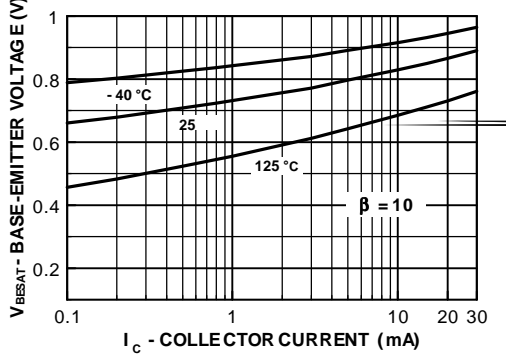

Base-Emitter ON Voltage vs Collector Current

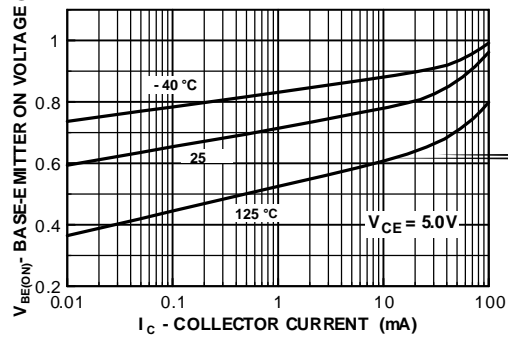

Collector Cut-Off Current vs Ambient Temperature

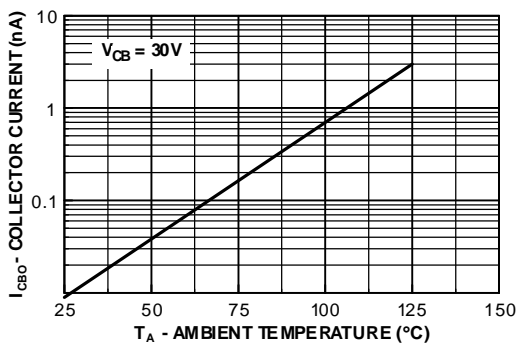

Power Dissipation vs Ambient Temperature

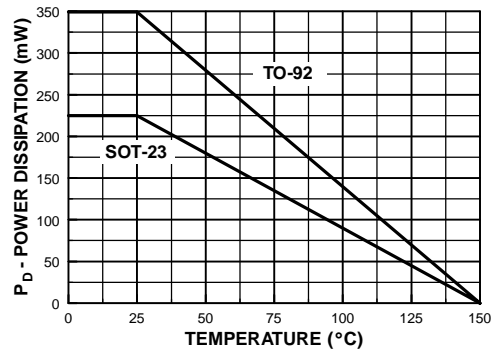

Capacitance vs Reverse Bias Voltage

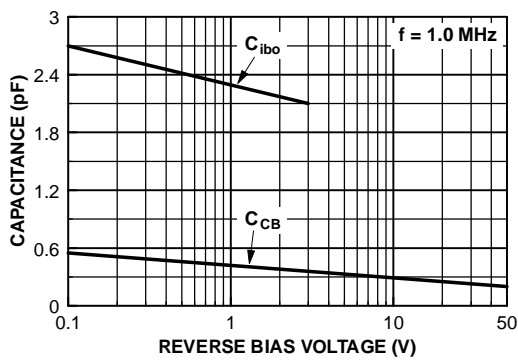

Contours of Constant Gain Bandwidth Product ( $f_T$ )

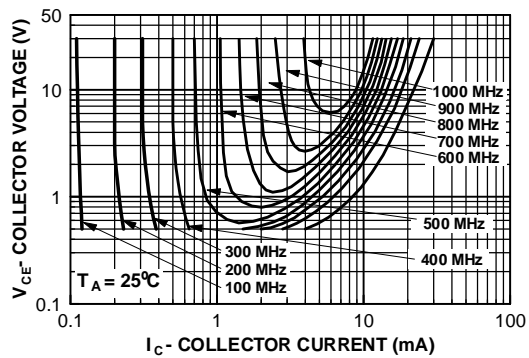

**NPN RF Transistor**  
(continued)

**Common Emitter Y Parameters**

**Input Admittance vs Collector Current**

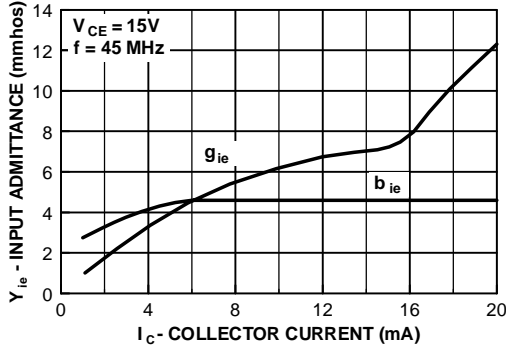

**Input Admittance vs Collector Current**

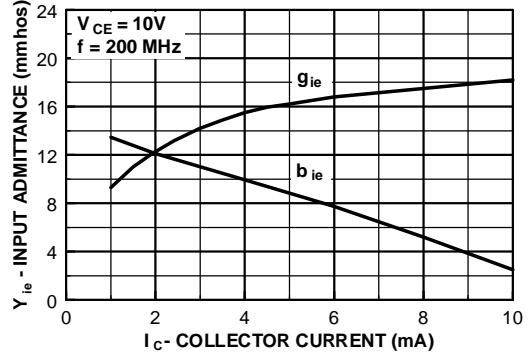

**Input Admittance vs Collector Voltage**

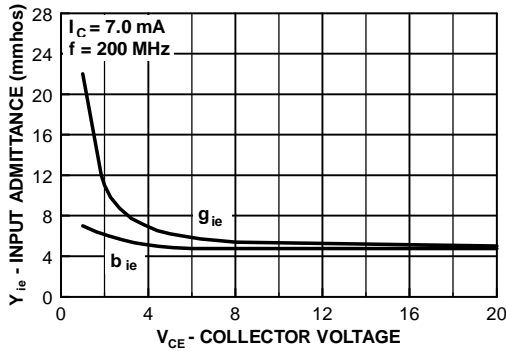

**Input Admittance vs Frequency**

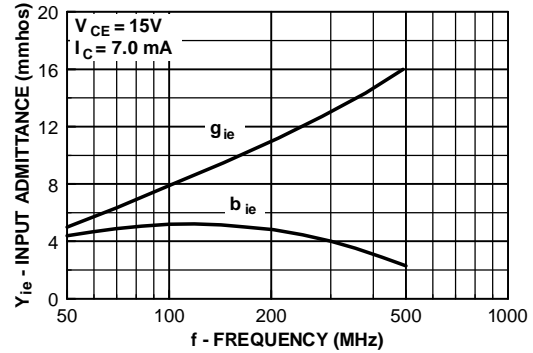

**Forward Transfer Admittance vs Collector Current**

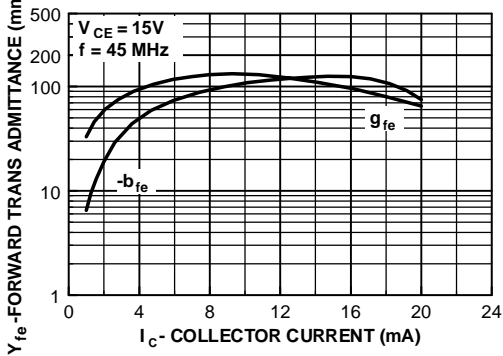

**Forward Transfer Admittance vs Collector Current**

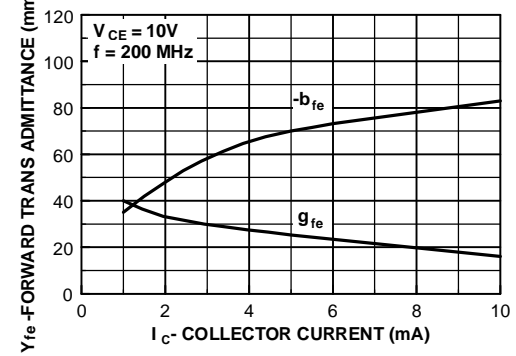

Common Emitter Y Parameters (continued)

Forward Transfer Admittance vs Collector Voltage

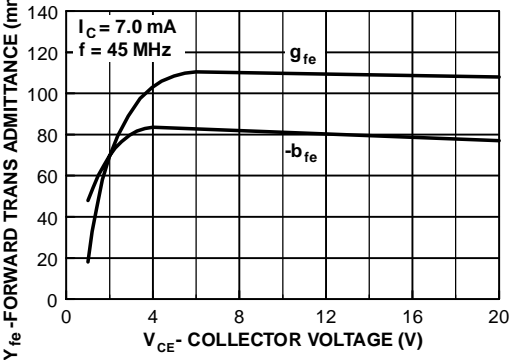

Forward Transfer Admittance vs Frequency

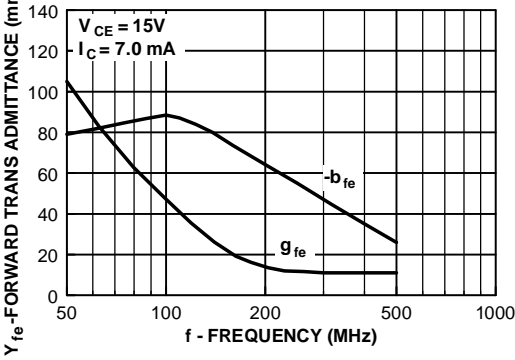

Reverse Transfer Admittance vs Collector Current

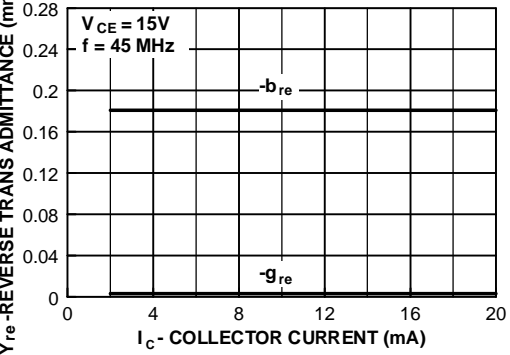

Reverse Transfer Admittance vs Collector Current

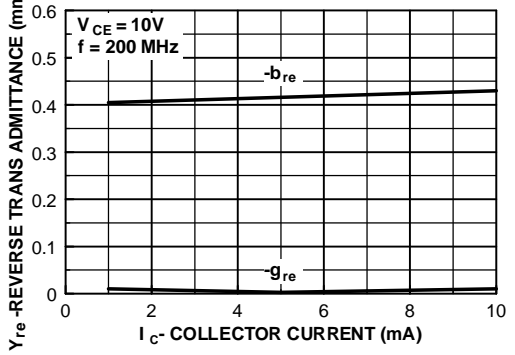

Reverse Transfer Admittance vs Collector Voltage

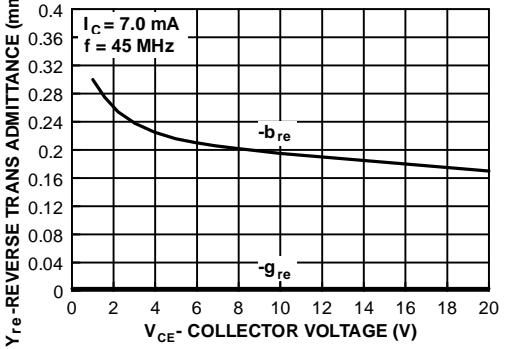

Reverse Transfer Admittance vs Frequency

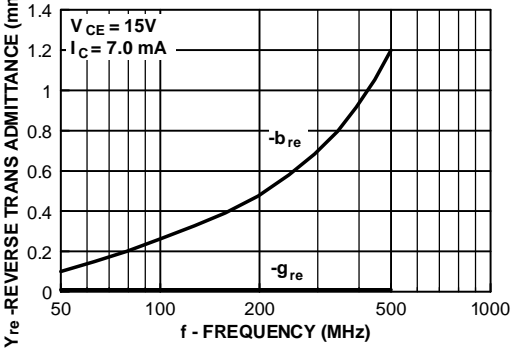

Common Emitter Y Parameters (continued)

Output Admittance vs Collector Current

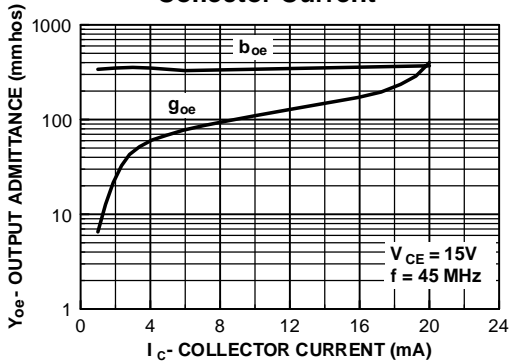

Output Admittance vs Collector Current

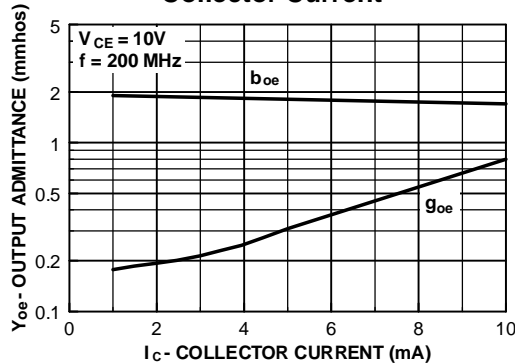

Output Admittance vs Collector Voltage

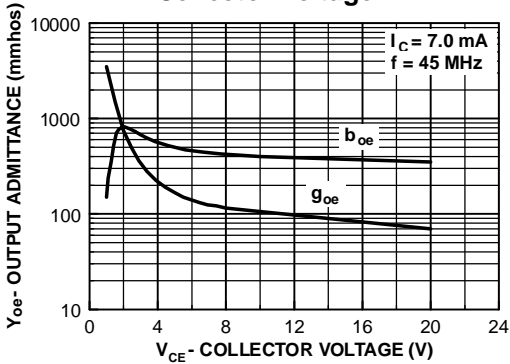

Output Admittance vs Frequency

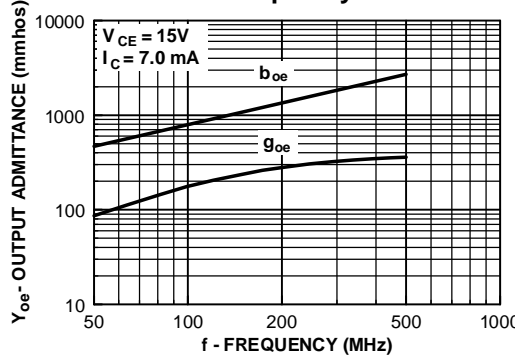

Power Gain and Noise Figure vs Collector Current

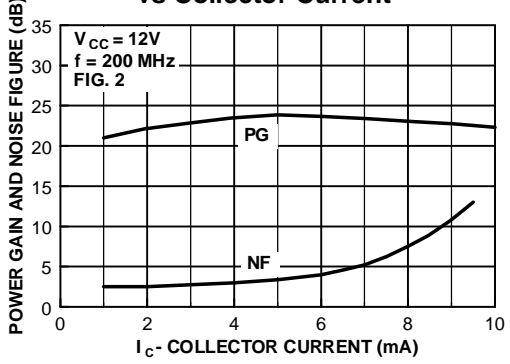

Conversion Gain vs Collector Current

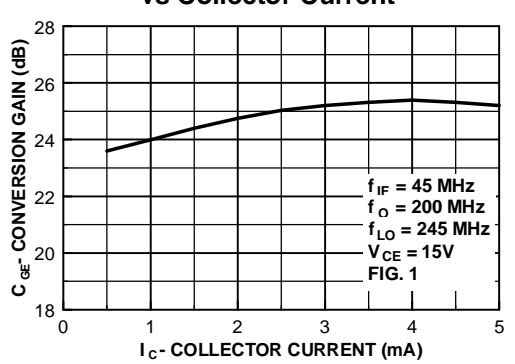

Test Circuits

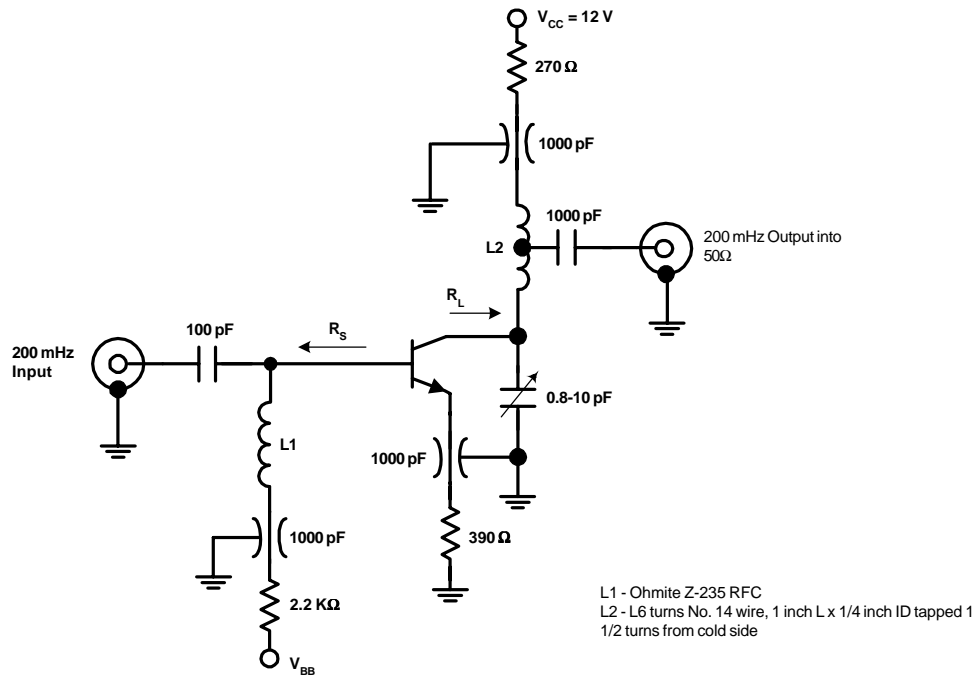

FIGURE 1: Unneutralized 200 MHz PG and NF Test Circuit

Test Circuits (continued)

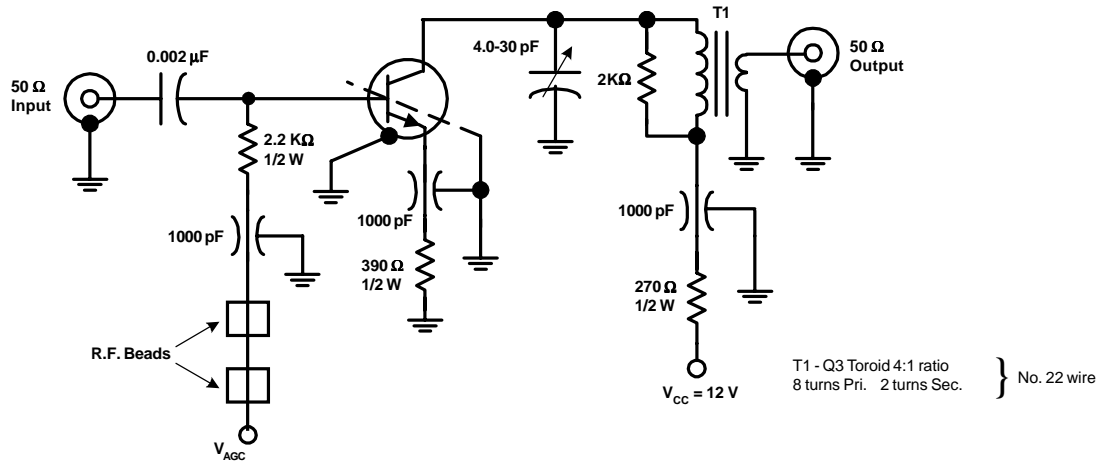

FIGURE 2: 45 MHz Power Gain Circuit

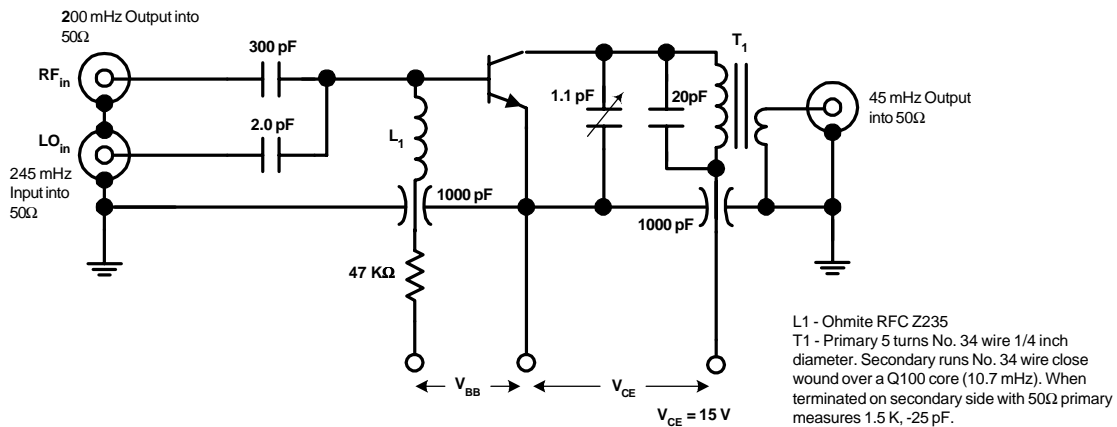

FIGURE 3: 200 MHz Conversion Gain Test Circuit