

**J309
J310**

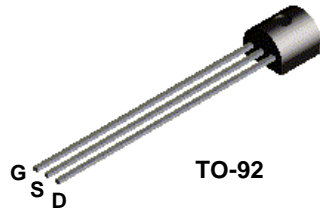

**MMBFJ309
MMBFJ310**



N-Channel RF Amplifier

This device is designed for VHF/UHF amplifier, oscillator and mixer applications. As a common gate amplifier, 16 dB at 100 MHz and 12 dB at 450 MHz can be realized. Sourced from Process 92.

Absolute Maximum Ratings*

TA = 25°C unless otherwise noted

| Symbol | Parameter | Value | Units |
|-----------------------------------|--------------------------------------------------|-------------|-------|
| V _{DS} | Drain-Source Voltage | 25 | V |
| V _{GS} | Gate-Source Voltage | - 25 | V |
| I _{GF} | Forward Gate Current | 10 | mA |
| T _J , T _{stg} | Operating and Storage Junction Temperature Range | -55 to +150 | °C |

*These ratings are limiting values above which the serviceability of any semiconductor device may be impaired.

NOTES:

- 1) These ratings are based on a maximum junction temperature of 150 degrees C.
- 2) These are steady state limits. The factory should be consulted on applications involving pulsed or low duty cycle operations.

Thermal Characteristics

TA = 25°C unless otherwise noted

| Symbol | Characteristic | Max | | Units |
|------------------|-----------------------------------------|-------------|-----------|-------|
| | | J309 / J310 | *MMBFJ309 | |
| P _D | Total Device Dissipation | 350 | 225 | mW |
| | Derate above 25°C | 2.8 | 1.8 | mW/°C |
| R _{θJC} | Thermal Resistance, Junction to Case | 125 | | °C/W |
| R _{θJA} | Thermal Resistance, Junction to Ambient | 357 | 556 | °C/W |

* Device mounted on FR-4 PCB 1.6" X 1.6" X 0.06."

N-Channel RF Amplifier

(continued)

Electrical Characteristics

TA = 25°C unless otherwise noted

| Symbol | Parameter | Test Conditions | Min | Typ | Max | Units |
|----------------------------|-------------------------------|---------------------------------------------------------------------------------|--------------|-----|--------------|---------------|
| OFF CHARACTERISTICS | | | | | | |
| $V_{(BR)GSS}$ | Gate-Source Breakdown Voltage | $I_G = -1.0 \mu A, V_{DS} = 0$ | -25 | | | V |
| I_{GSS} | Gate Reverse Current | $V_{GS} = -15 V, V_{DS} = 0$ $V_{GS} = -15 V, V_{DS} = 0, T_A = 125^\circ C$ | | | -1.0 -1.0 | nA μA |
| $V_{GS(off)}$ | Gate-Source Cutoff Voltage | $V_{DS} = 10 V, I_D = 1.0 nA$ | -1.0 -2.0 | | -4.0 -6.5 | V V |

ON CHARACTERISTICS

| | | | | | | |
|-------------|----------------------------------|-----------------------------|----------------------------|----------|----------|----------|
| I_{DSS} | Zero-Gate Voltage Drain Current* | $V_{DS} = 10 V, V_{GS} = 0$ | J309 J310 | 12 24 | 30 60 | mA mA |
| $V_{GS(f)}$ | Gate-Source Forward Voltage | $V_{DS} = 0, I_G = 1.0 mA$ | | | 1.0 | V |

SMALL SIGNAL CHARACTERISTICS

| | | | | | | |
|--------------|----------------------------------------------|------------------------------------------------|----------------------------|----------------|------------------|----------------------------------------------|
| $Re(Y_{is})$ | Common-Source Input Conductance | $V_{DS} = 10, I_D = 10 mA, f = 100 MHz$ | J309 J310 | | 0.7 0.5 | mmhos mmhos |
| $Re(Y_{os})$ | Common-Source Output Conductance | $V_{DS} = 10, I_D = 10 mA, f = 100 MHz$ | | | 0.25 | mmhos |
| G_{pg} | Common-Gate Power Gain | $V_{DS} = 10, I_D = 10 mA, f = 100 MHz$ | | | 16 | dB |
| $Re(Y_{fs})$ | Common-Source Forward Transconductance | $V_{DS} = 10, I_D = 10 mA, f = 100 MHz$ | | | 12 | mmhos |
| $Re(Y_{ig})$ | Common-Gate Input Conductance | $V_{DS} = 10, I_D = 10 mA, f = 100 MHz$ | | | 12 | mmhos |
| g_{fs} | Common-Source Forward Transconductance | $V_{DS} = 10, I_D = 10 mA, f = 1.0 kHz$ | J309 J310 | 10,000 8000 | | 20,000 18,000 $\mu mhos$ $\mu mhos$ |
| g_{os} | Common-Source Output Conductance | $V_{DS} = 10, I_D = 10 mA, f = 1.0 kHz$ | | | | 150 $\mu mhos$ |
| g_{fg} | Common-Gate Forward Conductance | $V_{DS} = 10, I_D = 10 mA, f = 1.0 kHz$ | J309 J310 | | 13,000 12,000 | $\mu mhos$ $\mu mhos$ |
| g_{og} | Common-Gate Output Conductance | $V_{DS} = 10, I_D = 10 mA, f = 1.0 kHz$ | J309 J310 | | 100 150 | $\mu mhos$ $\mu mhos$ |
| C_{dg} | Drain-Gate Capacitance | $V_{DS} = 0, V_{GS} = -10, f = 1.0 MHz$ | | | 2.0 | 2.5 pF |
| C_{sg} | Source-Gate Capacitance | $V_{DS} = 0, V_{GS} = -10, f = 1.0 MHz$ | | | 4.1 | 5.0 pF |
| NF | Noise Figure | $V_{DS} = 10 V, I_D = 10 mA,$ $f = 450 MHz$ | | | 3.0 | dB |
| e_n | Equivalent Short-Circuit Input Noise Voltage | $V_{DS} = 10 V, I_D = 10 mA,$ $f = 100 Hz$ | | | 6.0 | nV/ \sqrt{Hz} |

*Pulse Test: Pulse Width $\leq 300 ms$, Duty Cycle $\leq 2.0\%$

J309 / J310 / MMBFJ309 / MMBFJ310

Typical Characteristics

Transfer Characteristics

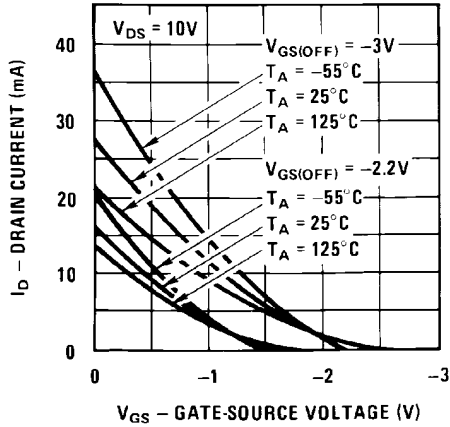

Transfer Characteristics

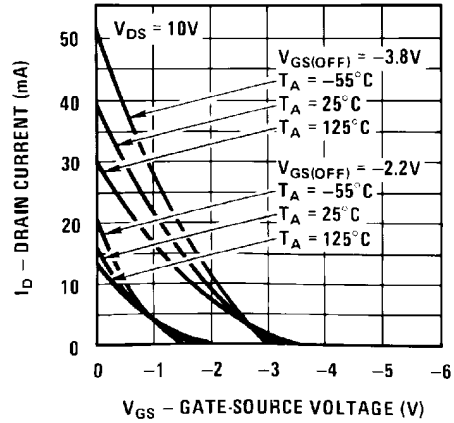

Transfer Characteristics

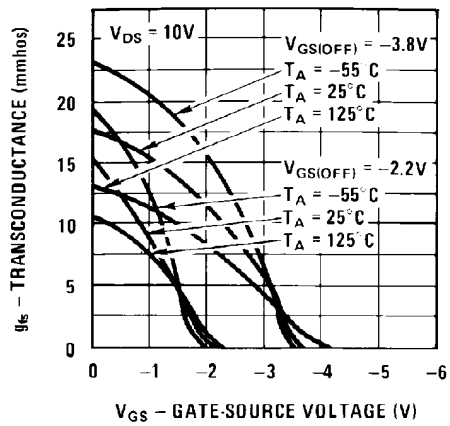

Transfer Characteristics

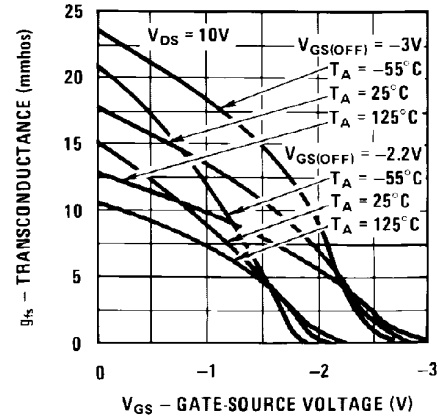

Input Admittance

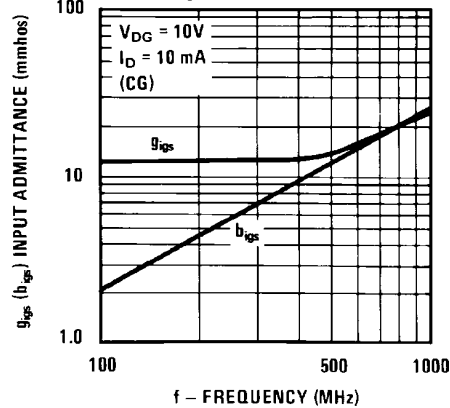

Forward Transadmittance

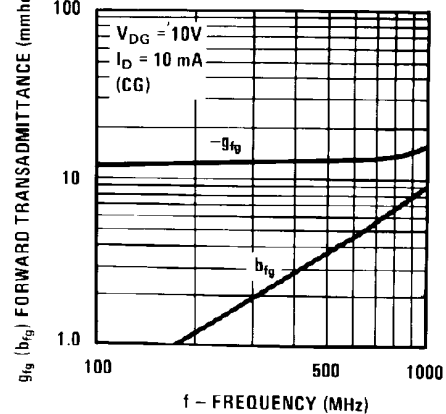

Typical Characteristics (continued)

Common Drain-Source

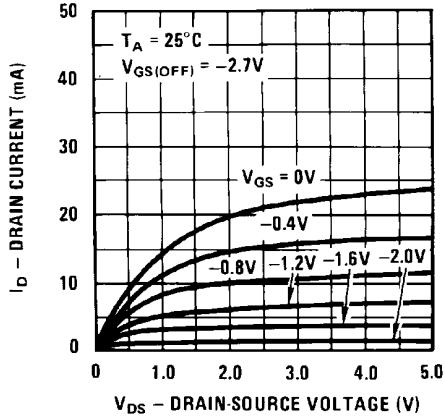

Output Conductance vs. Drain Current

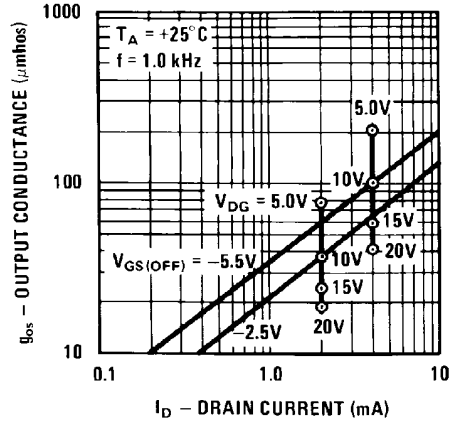

Output Admittance

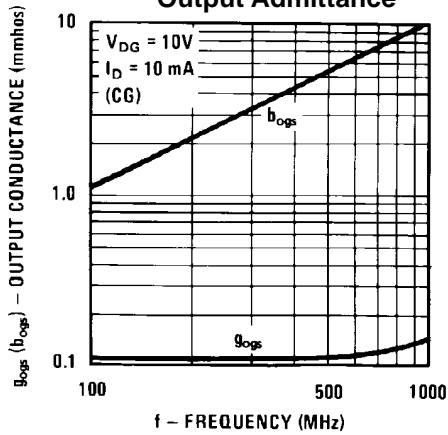

Capacitance vs. Voltage

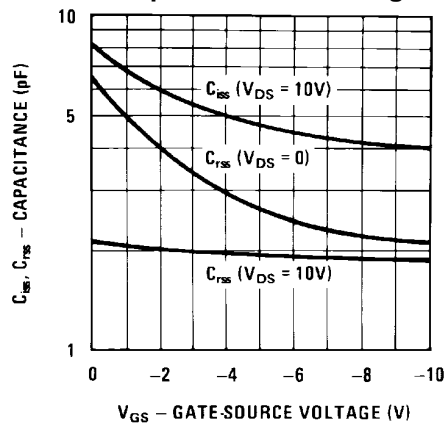

Noise Voltage vs. Frequency

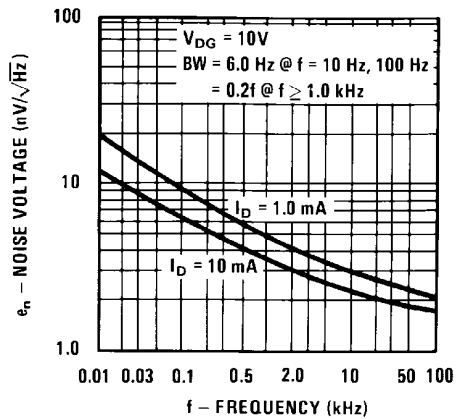

Reverse Transadmittance

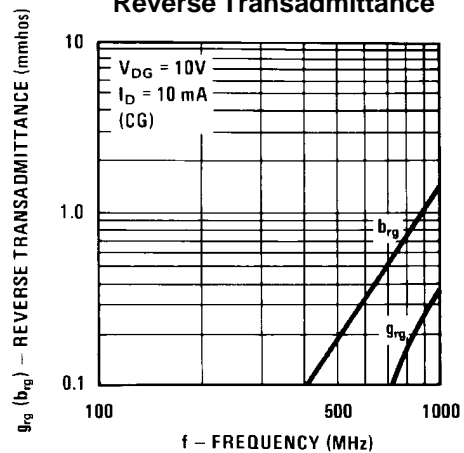

Typical Characteristics (continued)

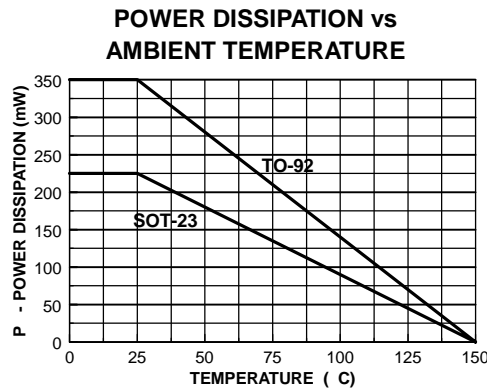
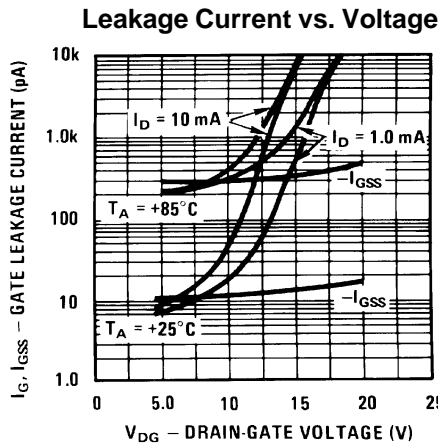
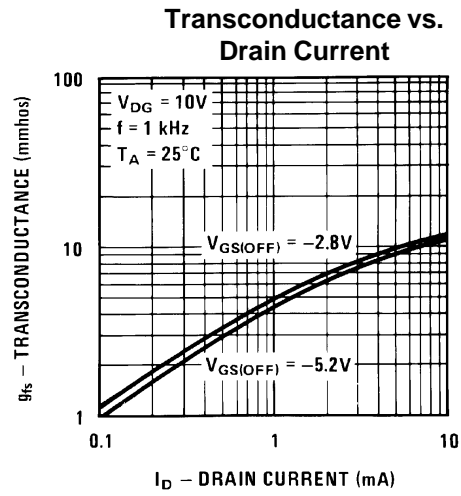
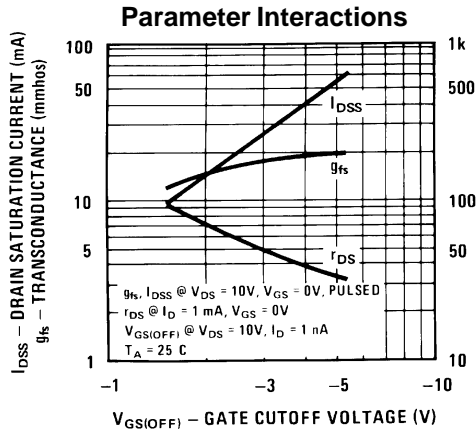

TO-92 Tape and Reel Data and Package Dimensions



TO-92 Packaging Configuration: Figure 1.0

FSCINT Label sample



F63TNR Label sample

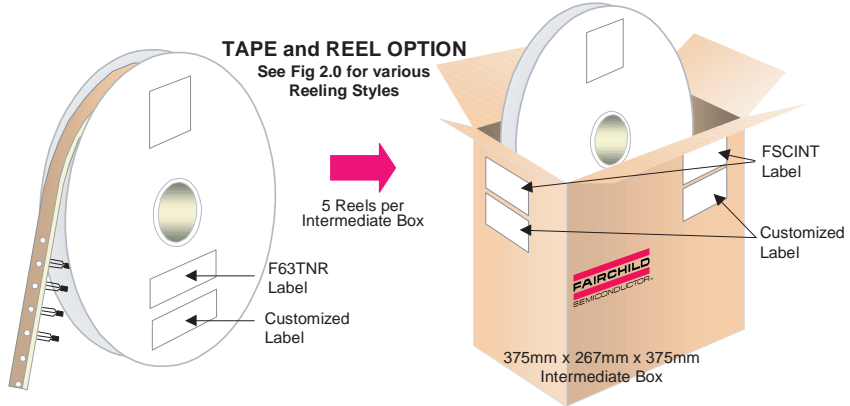

TO-92 TNR/AMMO PACKING INFORMATION

| Packing | Style | Quantity | EOL code |
|---------|-------|----------|----------|
| Reel | A | 2,000 | D26Z |
| | E | 2,000 | D27Z |
| Ammo | M | 2,000 | D74Z |
| | P | 2,000 | D75Z |

Unit weight = 0.22 gm
 Reel weight with components = 1.04 kg
 Ammo weight with components = 1.02 kg
 Max quantity per intermediate box = 10,000 units

AMMO PACK OPTION

See Fig 3.0 for 2 Ammo Pack Options

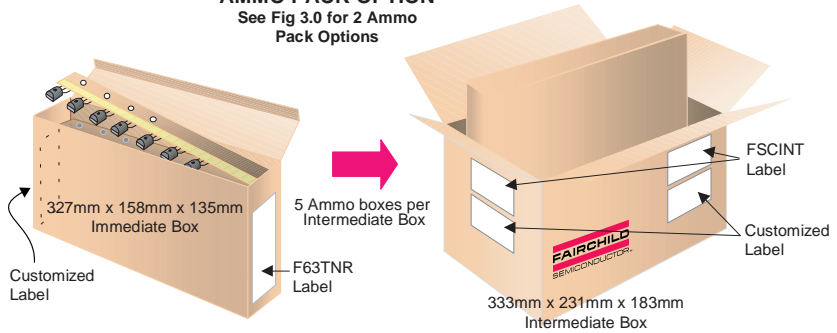

(TO-92) BULK PACKING INFORMATION

| EOL CODE | DESCRIPTION | LEADCLIP DIMENSION | QUANTITY |
|-------------|-------------------------|--------------------|-------------|
| J18Z | TO-18 OPTION STD | NO LEAD CLIP | 2.0 K / BOX |
| J05Z | TO-5 OPTION STD | NO LEAD CLIP | 1.5 K / BOX |
| NO EOL CODE | TO-92 STANDARD STRAIGHT | NO LEADCLIP | 2.0 K / BOX |

BULK OPTION

See Bulk Packing Information table

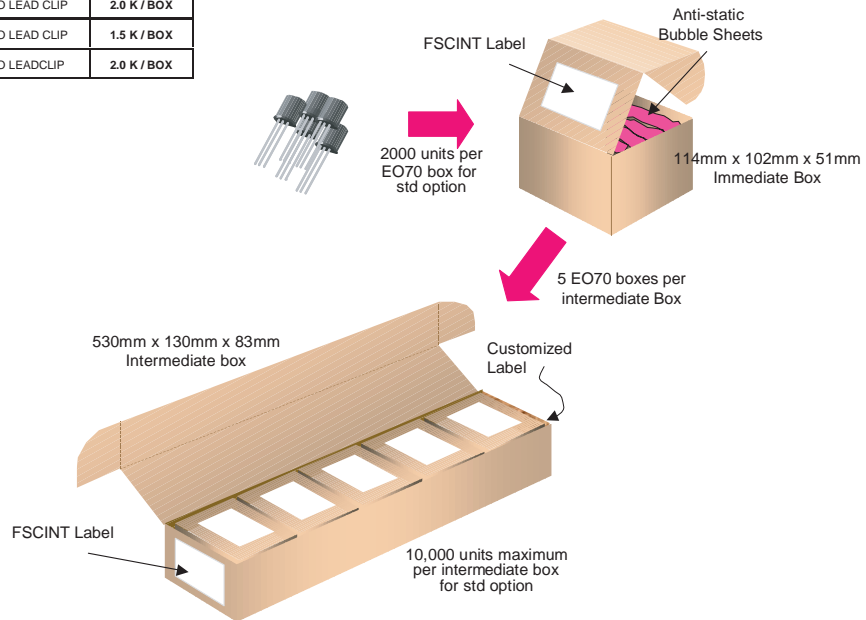

TO-92 Tape and Reel Data and Package Dimensions, continued

TO-92 Reeling Style

Configuration: Figure 2.0

Machine Option "A" (H)

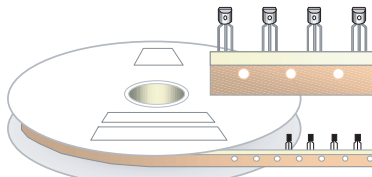

Style "A", D26Z, D70Z (s/h)

Machine Option "E" (J)

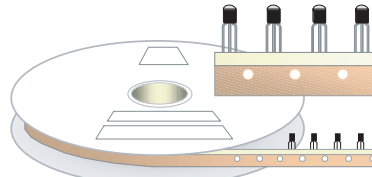

Style "E", D27Z, D71Z (s/h)

TO-92 Radial Ammo Packaging

Configuration: Figure 3.0

FIRST WIRE OFF IS COLLECTOR
ADHESIVE TAPE IS ON THE TOP SIDE
FLAT OF TRANSISTOR IS ON TOP

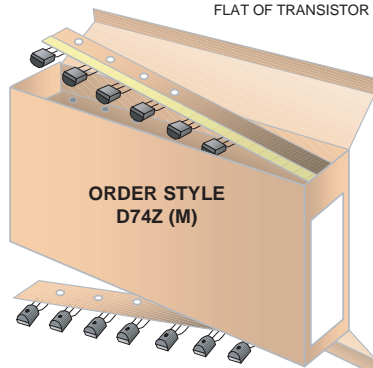

ORDER STYLE
D74Z (M)

FIRST WIRE OFF IS EMITTER (ON PKG. 92)
ADHESIVE TAPE IS ON BOTTOM SIDE
FLAT OF TRANSISTOR IS ON BOTTOM

FIRST WIRE OFF IS EMITTER
ADHESIVE TAPE IS ON THE TOP SIDE
FLAT OF TRANSISTOR IS ON BOTTOM

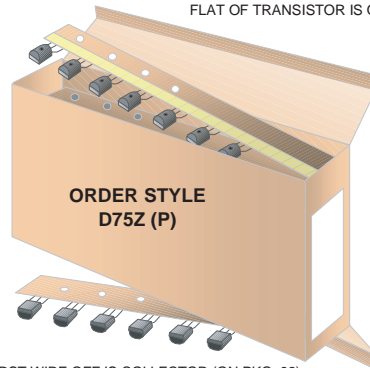

ORDER STYLE
D75Z (P)

FIRST WIRE OFF IS COLLECTOR (ON PKG. 92)
ADHESIVE TAPE IS ON BOTTOM SIDE
FLAT OF TRANSISTOR IS ON TOP

TO-92 Tape and Reel Data and Package Dimensions, continued

**TO-92 Tape and Reel Taping
Dimension Configuration: Figure 4.0**

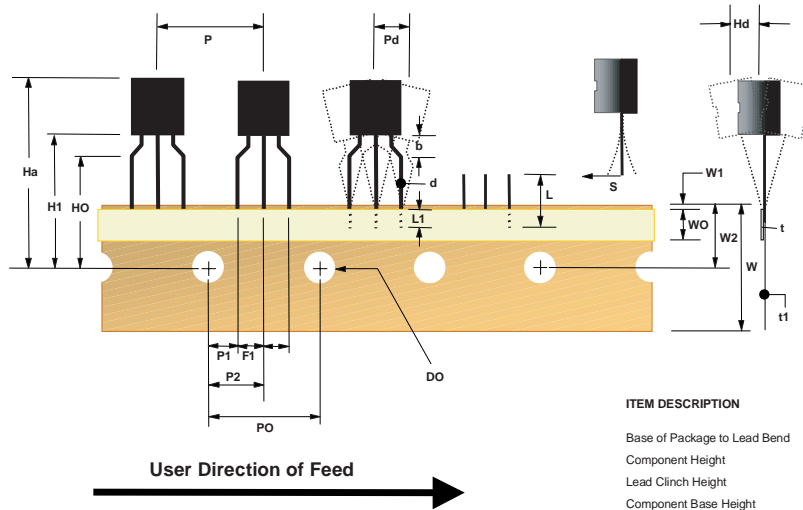

| ITEM DESCRIPTION | SYMBOL | DIMENSION |
|------------------------------------|--------|------------------------|
| Base of Package to Lead Bend | b | 0.098 (max) |
| Component Height | Ha | 0.928 (+/- 0.025) |
| Lead Clinch Height | HO | 0.630 (+/- 0.020) |
| Component Base Height | H1 | 0.748 (+/- 0.020) |
| Component Alignment (side/side) | Pd | 0.040 (max) |
| Component Alignment (front/back) | Hd | 0.031 (max) |
| Component Pitch | P | 0.500 (+/- 0.020) |
| Feed Hole Pitch | PO | 0.500 (+/- 0.008) |
| Hole Center to First Lead | P1 | 0.150 (+0.009, -0.010) |
| Hole Center to Component Center | P2 | 0.247 (+/- 0.007) |
| Lead Spread | F1/F2 | 0.104 (+/- 0.010) |
| Lead Thickness | d | 0.018 (+0.002, -0.003) |
| Cut Lead Length | L | 0.429 (max) |
| Taped Lead Length | L1 | 0.209 (+0.051, -0.052) |
| Taped Lead Thickness | t | 0.032 (+/- 0.006) |
| Carrier Tape Thickness | t1 | 0.021 (+/- 0.006) |
| Carrier Tape Width | W | 0.708 (+0.020, -0.019) |
| Hold - down Tape Width | WO | 0.236 (+/- 0.012) |
| Hold - down Tape position | W1 | 0.035 (max) |
| Feed Hole Position | W2 | 0.360 (+/- 0.025) |
| Sprocket Hole Diameter | DO | 0.157 (+0.008, -0.007) |
| Lead Spring Out | S | 0.004 (max) |

Note : All dimensions are in inches.

**TO-92 Reel
Configuration: Figure 5.0**

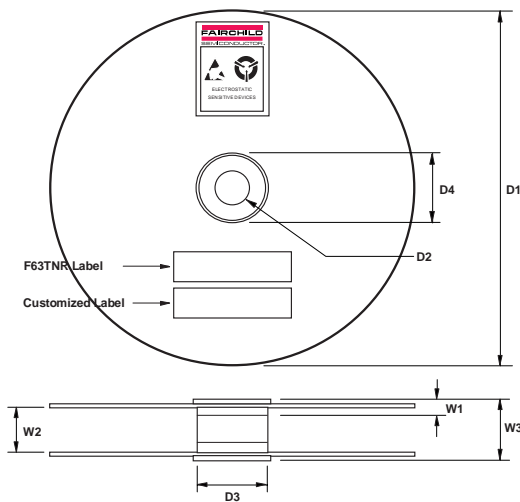

| ITEM DESCRIPTION | SYMBOL | MINIMUM | MAXIMUM |
|--------------------------------|--------|---------|---------|
| Reel Diameter | D1 | 13.975 | 14.025 |
| Arbor Hole Diameter (Standard) | D2 | 1.160 | 1.200 |
| (Small Hole) | D2 | 0.650 | 0.700 |
| Core Diameter | D3 | 3.100 | 3.300 |
| Hub Recess Inner Diameter | D4 | 2.700 | 3.100 |
| Hub Recess Depth | W1 | 0.370 | 0.570 |
| Flange to Flange Inner Width | W2 | 1.630 | 1.690 |
| Hub to Hub Center Width | W3 | | 2.090 |

Note: All dimensions are in inches

TO-92 Tape and Reel Data and Package Dimensions, continued

TO-92 (FS PKG Code 92, 94, 96)

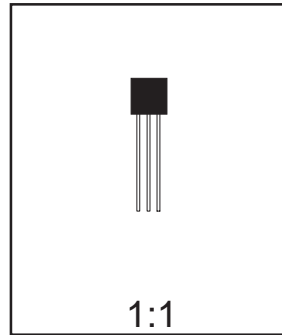
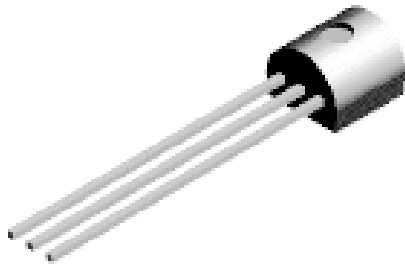

Scale 1:1 on letter size paper

Dimensions shown below are in:
inches [millimeters]

Part Weight per unit (gram): 0.1977

TO-92 (92,94,96)

| PIN | 92 | | 94 | | 96 | |
|-----|----|---|----|---|----|---|
| | B | F | B | F | B | F |
| 1 | E | D | E | D | B | S |
| 2 | B | S | C | G | E | D |
| 3 | C | G | B | S | C | G |

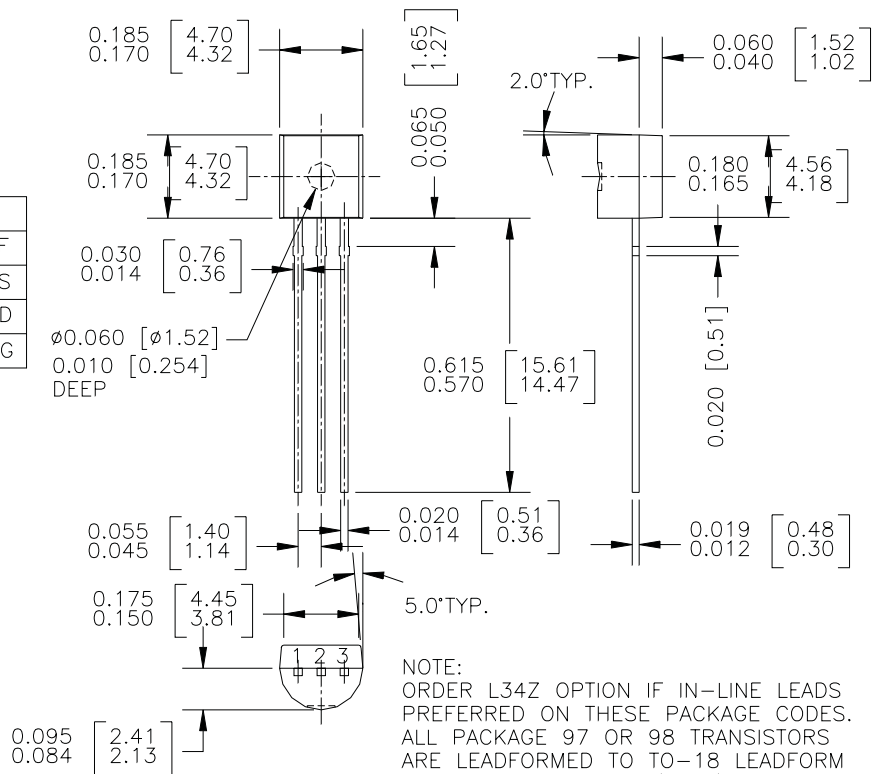

NOTE:
ORDER L34Z OPTION IF IN-LINE LEADS
PREFERRED ON THESE PACKAGE CODES.
ALL PACKAGE 97 OR 98 TRANSISTORS
ARE LEADFORMED TO TO-18 LEADFORM
REV.* CONFIGURATION (J35Z) PRIOR TO
BULK SHIPMENT.

SOT-23 Tape and Reel Data and Package Dimensions



SOT-23 Packaging Configuration: Figure 10

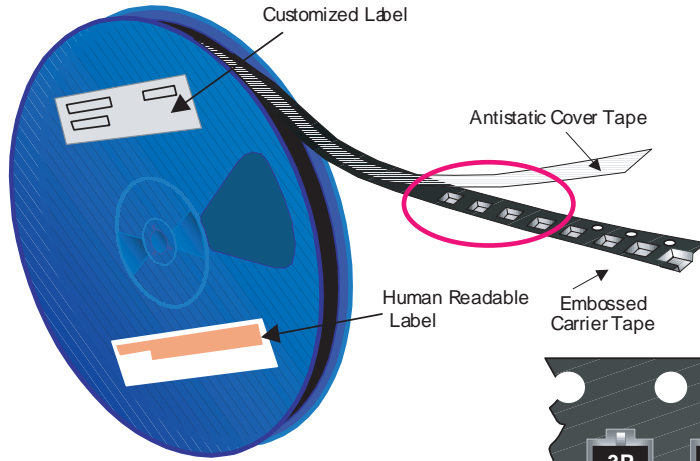

Packaging Description:

SOT-23 parts are shipped in tape. The carrier tape is made from a dissipative (carbon filled) polycarbonate resin. The cover tape is a multilayer film (Heat Activated Adhesive in nature) primarily composed of polyester film, adhesive layer, sealant, and anti-static sprayed agent. These reeled parts in standard option are shipped with 3,000 units per 7" or 177mm diameter reel. The reels are dark blue in color and is made of polystyrene plastic (anti-static coated). Other option comes in 10,000 units per 13" or 330mm diameter reel. This and some other options are described in the Packaging Information table.

These full reels are individually labeled and placed inside a standard intermediate made of recyclable corrugated brown paper with a Fairchild logo printing. One pizza box contains eight reels maximum. And these intermediate boxes are placed inside a labeled shipping box which comes in different sizes depending on the number of parts shipped.

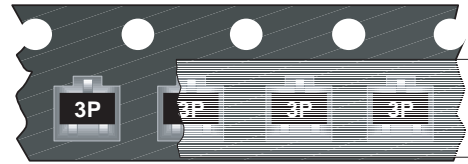

| SOT-23 Packaging Information | | |
|------------------------------|-------------------------|------------|
| Packaging Option | Standard (no flow code) | D87Z |
| Packaging type | TNR | TNR |
| Qty per Reel/Tube/Bag | 3,000 | 10,000 |
| Reel Size | 7" Dia | 13" |
| Box Dimension (mm) | 187x107x183 | 343x343x64 |
| Max qty per Box | 24,000 | 30,000 |
| Weight per unit (gm) | 0.0082 | 0.0082 |
| Weight per Reel (kg) | 0.1175 | 0.4006 |
| Note/Comments | | |

SOT-23 Unit Orientation

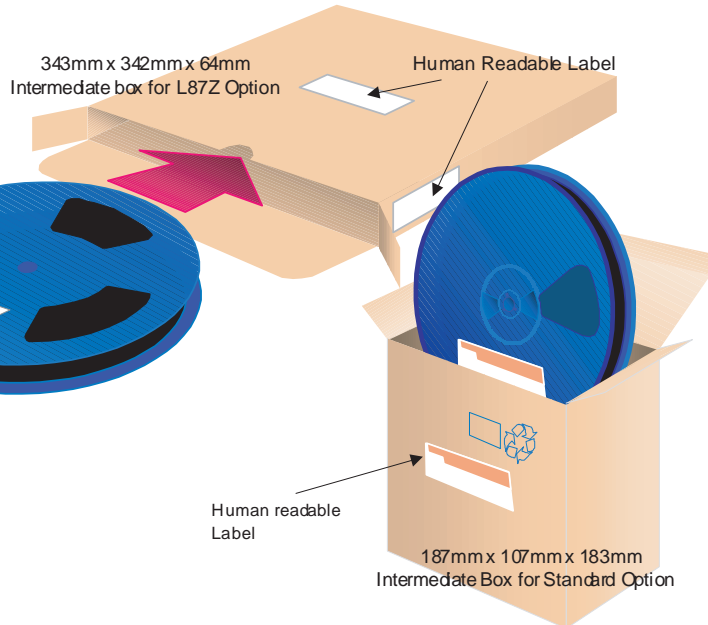

Human Readable Label sample



SOT-23 Tape Leader and Trailer Configuration: Figure 20

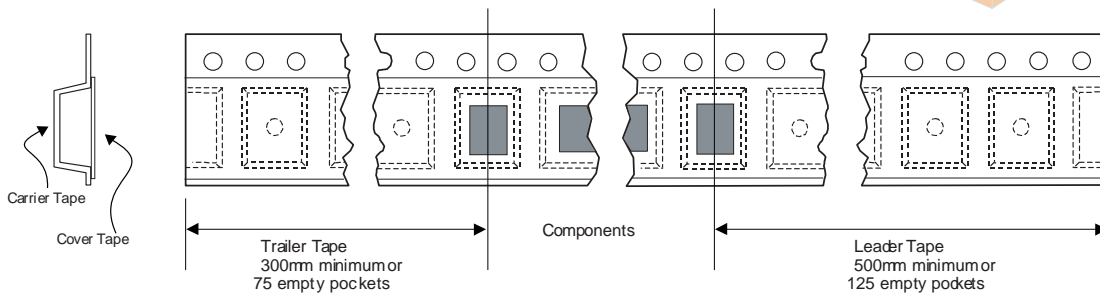

SOT-23 Tape and Reel Data and Package Dimensions, continued

SOT-23 Embossed Carrier Tape Configuration: Figure 3.0

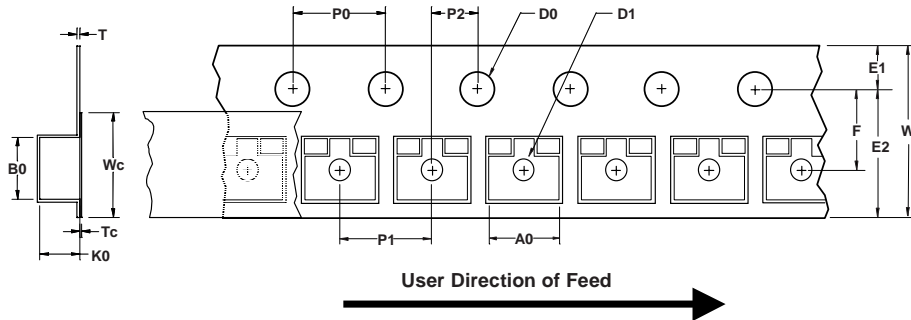

| Dimensions are in millimeter | | | | | | | | | | | | | | |
|------------------------------|---------------|---------------|-------------|---------------|-----------------|---------------|-------------|---------------|-------------|-------------|---------------|-----------------|-------------|---------------|
| Pkg type | A0 | B0 | W | D0 | D1 | E1 | E2 | F | P1 | P0 | K0 | T | Wc | Tc |
| SOT-23 (8mm) | 3.15 ±0.10 | 2.77 ±0.10 | 8.0 ±0.3 | 1.55 ±0.05 | 1.125 ±0.125 | 1.75 ±0.10 | 6.25 min | 3.50 ±0.05 | 4.0 ±0.1 | 4.0 ±0.1 | 1.30 ±0.10 | 0.228 ±0.013 | 5.2 ±0.3 | 0.06 ±0.02 |

Notes: A0, B0, and K0 dimensions are determined with respect to the EIA/Jedec RS-481 rotational and lateral movement requirements (see sketches A, B, and C).

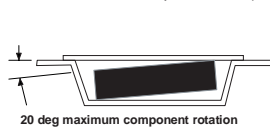

Sketch A (Side or Front Sectional View)
Component Rotation

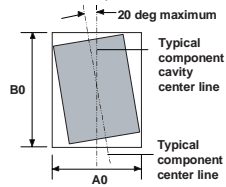

Sketch B (Top View)
Component Rotation

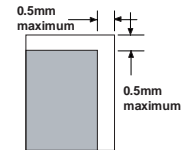

Sketch C (Top View)
Component lateral movement

SOT-23 Reel Configuration: Figure 4.0

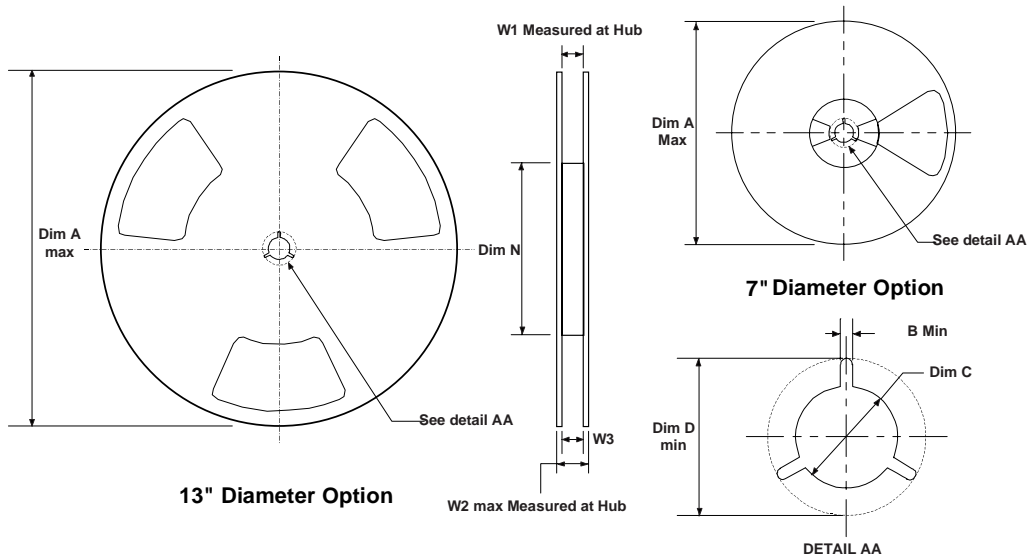

| Dimensions are in inches and millimeters | | | | | | | | | |
|------------------------------------------|-------------|---------------|--------------|-----------------------------------|---------------|-------------|-----------------------------------|---------------|----------------------------|
| Tape Size | Reel Option | Dim A | Dim B | Dim C | Dim D | Dim N | Dim W1 | Dim W2 | Dim W3 (LSL-USL) |
| 8mm | 7" Dia | 7.00 177.8 | 0.059 1.5 | 512 +0.020/-0.008 13 +0.5/-0.2 | 0.795 20.2 | 2.165 55 | 0.331 +0.059/-0.000 8.4 +1.5/0 | 0.567 14.4 | 0.311 -0.429 7.9 - 10.9 |
| 8mm | 13" Dia | 13.00 330 | 0.059 1.5 | 512 +0.020/-0.008 13 +0.5/-0.2 | 0.795 20.2 | 4.00 100 | 0.331 +0.059/-0.000 8.4 +1.5/0 | 0.567 14.4 | 0.311 -0.429 7.9 - 10.9 |

SOT-23 Tape and Reel Data and Package Dimensions, continued

SOT-23 (FS PKG Code 49)

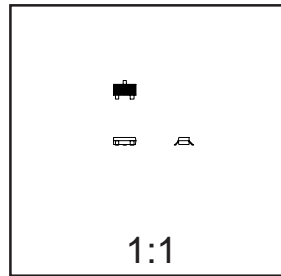
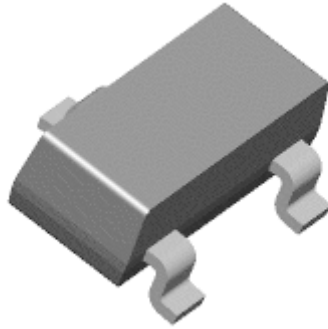

Scale 1:1 on letter size paper

Dimensions shown below are in:
inches [millimeters]

Part Weight per unit (gram): 0.0082

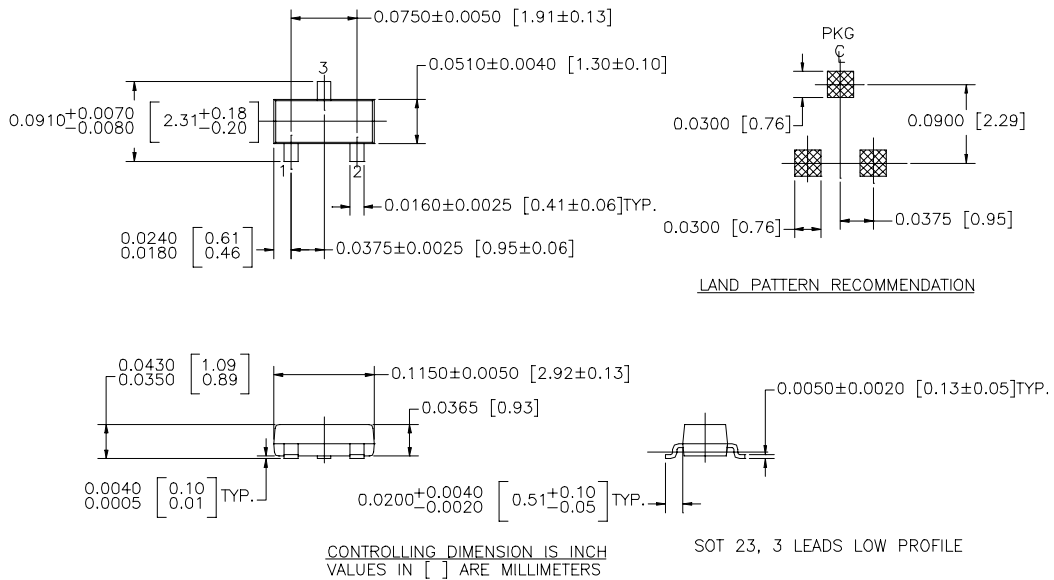

NOTE : UNLESS OTHERWISE SPECIFIED

- STANDARD LEAD FINISH 150 MICROINCHES / 3.81 MICROMETERS
MINIMUM TIN / LEAD (SOLDER) ON ALLOY 42
- REFERENCE JEDEC REGISTRATION TO-236, VARIATION AB, ISSUE G, DATED JUL 1993

TRADEMARKS

The following are registered and unregistered trademarks Fairchild Semiconductor owns or is authorized to use and is not intended to be an exhaustive list of all such trademarks.

| | | |
|----------------------|---------------|------|
| ACEx™ | ISOPLANAR™ | UHC™ |
| CoolFET™ | MICROWIRE™ | VCX™ |
| CROSSVOLT™ | POP™ | |
| E ² CMOS™ | PowerTrench™ | |
| FACT™ | QST™ | |
| FACT Quiet Series™ | Quiet Series™ | |
| FAST® | SuperSOT™-3 | |
| FASTr™ | SuperSOT™-6 | |
| GTO™ | SuperSOT™-8 | |
| HiSeC™ | TinyLogic™ | |

DISCLAIMER

FAIRCHILD SEMICONDUCTOR RESERVES THE RIGHT TO MAKE CHANGES WITHOUT FURTHER NOTICE TO ANY PRODUCTS HEREIN TO IMPROVE RELIABILITY, FUNCTION OR DESIGN. FAIRCHILD DOES NOT ASSUME ANY LIABILITY ARISING OUT OF THE APPLICATION OR USE OF ANY PRODUCT OR CIRCUIT DESCRIBED HEREIN; NEITHER DOES IT CONVEY ANY LICENSE UNDER ITS PATENT RIGHTS, NOR THE RIGHTS OF OTHERS.

LIFE SUPPORT POLICY

FAIRCHILD'S PRODUCTS ARE NOT AUTHORIZED FOR USE AS CRITICAL COMPONENTS IN LIFE SUPPORT DEVICES OR SYSTEMS WITHOUT THE EXPRESS WRITTEN APPROVAL OF FAIRCHILD SEMICONDUCTOR CORPORATION. As used herein:

1. Life support devices or systems are devices or systems which, (a) are intended for surgical implant into the body, or (b) support or sustain life, or (c) whose failure to perform when properly used in accordance with instructions for use provided in the labeling, can be reasonably expected to result in significant injury to the user.
2. A critical component is any component of a life support device or system whose failure to perform can be reasonably expected to cause the failure of the life support device or system, or to affect its safety or effectiveness.

PRODUCT STATUS DEFINITIONS

Definition of Terms

| Datasheet Identification | Product Status | Definition |
|--------------------------|------------------------|-----------------------------------------------------------------------------------------------------------------------------------------------------------------------------------------------------------------------|
| Advance Information | Formative or In Design | This datasheet contains the design specifications for product development. Specifications may change in any manner without notice. |
| Preliminary | First Production | This datasheet contains preliminary data, and supplementary data will be published at a later date. Fairchild Semiconductor reserves the right to make changes at any time without notice in order to improve design. |
| No Identification Needed | Full Production | This datasheet contains final specifications. Fairchild Semiconductor reserves the right to make changes at any time without notice in order to improve design. |
| Obsolete | Not In Production | This datasheet contains specifications on a product that has been discontinued by Fairchild semiconductor. The datasheet is printed for reference information only. |