



# SP3070E - SP3078E Family

## ±15kV ESD-Protected, 3.3V, 1/8 Load, Failsafe RS-485/RS422 Transceivers

### FEATURES

- ±15kV ESD protection for RS485 pins
- 3.3V low-power operation
- Advanced Receiver-failsafe protection for open, shorted or terminated lines
- Up to 256 Transceivers may share Bus
- Very low load for 8x greater fanout
- Hot Swap glitch protection  $\overline{RE}$  and DE
- Thermal shutdown protects against driver contention
- Available in three industry standard footprints
  - SP3070E, 3073 and 3076 in Full-Duplex (14 pin)
  - SP3071E, 3074 and 3077 in Full-Duplex (8 pin)
  - SP3072E, 3075 and 3078 in Half-Duplex (8 pin)
- Three applications-optimized speed grades
  - SP3070E-72E: 250kbps slew-limited
  - SP3073E-75E: 500kbps slew-limited
  - SP3076E-78E: 16Mbps high speed
- Small form factor SO-narrow packages
- Industrial (-40 to +85°C) and Extended (-40 to +125°C) temperature grades

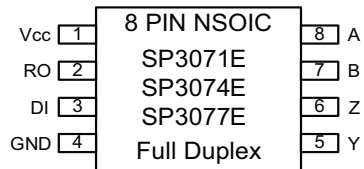
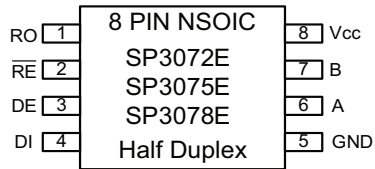

Now Available in Lead Free Packaging

### APPLICATIONS

- Industrial Control, Utility Meters Building Automation, Instrumentation, Point of Sale

### DESCRIPTION

The SP3070E-3078E differential line transceivers are suitable for bidirectional communication on balanced multipoint bus transmission lines and comply with both RS485 and RS422 EIA Standards. Each device consists of a differential driver and differential receiver. All devices operate from a 3.3V power supply.

High receiver input impedance allows a large number of transceivers to share a common data bus while maintaining signal margin and without excessive loading or use of expensive repeaters. The high impedance driver output is maintained over the entire common-mode voltage range from -7 to +12V. Receivers will failsafe to logic 1 output when inputs are open, shorted or terminated. Drivers include built-in short-circuit protection and a thermal-overload shutdown to protect against excessive power dissipation from bus contention or cable faults. All RS485 receiver inputs and driver outputs are ESD protected up to ±15kV (Air-Gap and Human Body Model) and up to ±8kV Contact discharge (IEC 61000-4-2). The SP3070E-SP3078E devices may not achieve optimal transmit performance if the connected receiver includes a biasing network to 5.0V without a termination resistor. Please see Exar Application Note ANI#21 for further details.

## DEVICE ARCHITECTURE AND BLOCK DIAGRAMS

Devices are available in three industry standard architectures and footprints. In each footprint there are three speed grades available.



### 14 Pin Full Duplex:

SP3070E, 250kbps slew limited

SP3073E, 500kbps slew limited

SP3076E, 16Mbps



### 8 Pin Full Duplex:

SP3071E, 250kbps slew limited

SP3074E, 500kbps slew limited

SP3077E, 16Mbps



### 8 Pin Half Duplex:

SP3072E, 250kbps slew limited

SP3075E, 500kbps slew limited

SP3078E, 16Mbps

## ABSOLUTE MAXIMUM RATINGS

These are stress ratings only and functional operation of the device at these ratings or any other above those indicated in the operation sections of the specifications below is not implied. Exposure to absolute maximum rating conditions for extended periods of time may affect reliability.

$V_{CC}$ .....	+6.0V
Input Voltage at control input pins ( $\overline{RE}$ , DE).....	-0.3V to 6V
Driver Input Voltage ( $\overline{RE}$ , DE).....	-0.3V to 6V
Driver Output Voltage (A, B, Y, & Z).....	-8V to +13V
Receiver Input Voltage (A, B).....	-8V to +13V
Continuous Power Dissipation at $T_A = 70^\circ\text{C}$	

8-pin SO (derate 5.88mW/ $^\circ\text{C}$ above $+70^\circ\text{C}$ ).....	471mW
14-pin SO (derate 8.33mW/ $^\circ\text{C}$ above $+70^\circ\text{C}$ ).....	667mW

Operating Temperature Ranges	
SP307XE_MN.....	-40 $^\circ\text{C}$ to +125 $^\circ\text{C}$
SP307XE_EN.....	-40 $^\circ\text{C}$ to +85 $^\circ\text{C}$
Junction Temperature.....	+150 $^\circ\text{C}$
Storage Temperature Range.....	-65 $^\circ\text{C}$ to +150 $^\circ\text{C}$
Lead Temperature (soldering, 10s).....	+300 $^\circ\text{C}$

## ELECTRICAL CHARACTERISTICS

Unless otherwise noted  $V_{CC} = +3.3 \pm 0.3\text{V}$ , ambient temperature  $T_{MIN} < T_A < T_{MAX}$ . Typical values are at  $V_{CC} = 3.3$ , ambient temperature  $T_A = +25^\circ\text{C}$ . The  $\diamond$  denotes the specifications which apply over the full operating range unless otherwise noted.

PARAMETER	SYM.	MIN.	TYP.	MAX.	UNITS	*	CONDITIONS	
Differential Driver Output	$V_{OD}$	2		$V_{CC}$	V		RL = 100 (RS-422), Figure 1	
		1.5		$V_{CC}$			RL = 54 (RS-485), Figure 1	
				$V_{CC}$			$\diamond$ No Load	
Change in Magnitude of Differential Output Voltage	$V_{OD}$			0.2	V	$\diamond$	RL = 54 or 100, Figure 1	
Driver Common Mode Output Voltage	$V_{OC}$		$V_{CC}/2$	3	V	$\diamond$	RL = 54 or 100, Figure 1	
Change in Magnitude of Common Mode Output Voltage	$ V_{OC} $			$\pm 0.2$	V		RL = 54 or 100, Figure 1	
Input High Voltage	$V_{IH}$	2			V	$\diamond$	DE, DI, $\overline{RE}$	
Input Low Voltage	$V_{IL}$			0.8	V		DE, DI, $\overline{RE}$	
Input Hysteresis	$V_{HYS}$		100		mV	$\diamond$	DE, DI, $\overline{RE}$	
Input Current	$I_{IN}$	-1		1	$\mu\text{A}$	$\diamond$	DE, DI, $\overline{RE}$	
Input Impedance First Transition (Hotswap)		1		10	k	$\diamond$	DE, $\overline{RE}$ First transition will draw more current (Hotswap)	
Output Leakage (Y and Z) Full Duplex (A and B)	$I_O$			+125	$\mu\text{A}$	$\diamond$	DE = GND	$V_{IN} = +12\text{V}$
		-100				$\diamond$	$V_{CC} = \text{GND or } 3.6\text{V}$	$V_{IN} = -7\text{V}$
Driver Short-Circuit Current	$I_{OSD}$	0		$\pm 250$	mA		-7V $V_{OUT}$ 12V, (Figure 4A)	
		-250		0				

## ELECTRICAL CHARACTERISTICS

Unless otherwise noted  $V_{CC} = +3.3 \pm 0.3V$ , ambient temperature  $T_{MIN} < T_A < T_{MAX}$ . Typical values are at  $V_{CC} = 3.3$ , ambient temperature  $T_A = +25^\circ C$ . The  $\diamond$  denotes the specifications which apply over the full operating range unless otherwise noted.

PARAMETERS	SYM	MIN	TYP	MAX	UNITS	*	CONDITIONS
Input Current (A and B) Half Duplex	$I_{A,B}$			125	$\mu A$	*	DE = GND $V_{CC} = GND$ or 3.6 $V_{IN} = +12V$ $V_{IN} = -7V$
		-100					
Thermal-Shutdown Threshold	$T_{TS}$		165		$^\circ C$	*	
Thermal Shutdown Hysteresis	$T_{TSH}$		15		$^\circ C$	*	
RECEIVER							
Receiver Differential Threshold (Sensitivity)	$V_{TH}$	-200	-125	-50	mV		-7V $V_{CM}$ 12V
Receiver Input Hysteresis	$V_{TH}$		15		mV	*	Va + Vb = 0V
RO Output High Voltage	$V_{OH}$	$V_{CC} - 0.6$			V	*	$I_O = -1mA$
RO Output Low Voltage	$V_{OL}$			0.4	V	*	$I_O = 1mA$
Tri-State Output Current at Receiver	$I_{OZR}$			+/-1	$\mu A$	*	0 $V_O$ $V_{CC}$
Receiver Input Resistance	$R_{IN}$	96			k	*	-7V $V_{CM}$ 12V
Receiver Output Short-Circuit Current	$I_{OZR}$			$\pm 60$	mA		0V $V_{RO}$ $V_{CC}$
SUPPLY CURRENT							
Supply Current	$I_{CC}$		0.8	1.5	mA	*	No Load, $\overline{RE} = 0$ , DE = $V_{CC}$
			0.8	1.5			No Load, $\overline{RE} = V_{CC}$ , DE = $V_{CC}$
			0.8	1.5			No Load, $\overline{RE} = 0$ , DE = 0
Supply Current in Shutdown mode	$I_{SHDN}$		0.05	3	$\mu A$		$\overline{RE} = V_{CC}$ , DE = GND
ESD PROTECTION							
ESD Protection for Y, Z, A, and B		$\pm 15$			kV	*	Human Body Model
		$\pm 15$					Air Gap (IEC 1000-4-2)
		$\pm 8$					Contact (IEC 1000-4-2)

## DRIVER SWITCHING CHARACTERISTICS

Unless otherwise noted  $V_{CC} = +3.3 \pm 0.3V$ , ambient temperature  $T_{MIN} < T_A < T_{MAX}$ . Typical values are at  $V_{CC} = 3.3$ , ambient temperature  $T_A = +25^\circ C$ .

SP3070E, SP3071E & SP3072E Driver Switching Characteristics					
DRIVER CHARACTERISTICS:	Conditions	Min.	Typ.	Max.	Unit
Data Signaling Rate	Duty Cycle 40 to 60%	250			Kbps
Driver Propagation Delay ( $t_{PHL}$ , $t_{PLH}$ )	$R_L = 54\Omega$ , $C_L = 50pF$ , Figure 2 & 3	250		1500	ns
Driver Output Rise/Fall Time ( $t_r$ , $t_f$ )		350		1600	ns
Driver Differential Skew ( $t_{PLH} - t_{PHL}$ )				200	ns
Driver Enable to Output High ( $t_{ZH}$ )	$R_L = 500\Omega$ , $C_L = 50pF$ , Figure 4 & 5			2500	ns
Driver Enable to Output Low ( $t_{ZL}$ )				2500	ns
Driver Disable from Output High ( $t_{HZ}$ )				100	ns
Driver Disable from Output Low ( $t_{LZ}$ )				100	ns
Driver Enable from Shutdown to Output High ( $t_{ZH(SHDN)}$ )	Figure 4			5500	ns
Driver Enable from Shutdown to Output Low ( $t_{ZL(SHDN)}$ )	Figure 5			5500	ns
Time to Shutdown ( $t_{SHDN}$ )		50	200	600	ns

## RECEIVER SWITCHING CHARACTERISTICS

Unless otherwise noted  $V_{CC} = +3.3 \pm 0.3V$ , ambient temperature  $T_{MIN} < T_A < T_{MAX}$ . Typical values are at  $V_{CC} = 3.3$ , ambient temperature  $T_A = +25^\circ C$ .

SP3070E, SP3071E & SP3072E Receiver Switching Characteristics					
RECEIVER CHARACTERISTICS:	Conditions	Min.	Typ.	Max.	Unit
Data Signaling Rate	Duty Cycle 40 to 60%	250			Kbps
Receiver Propagation Delay ( $t_{PLH}$ , $t_{PHL}$ )	$C_L = 15pF$ , Figure 6 & 7			200	ns
Propagation Delay Skew ( $t_{PLH}$ , $t_{PHL}$ )				30	ns
Receiver Enable to Output High ( $t_{ZH}$ )	Figure 8			50	ns
Receiver Enable to Output Low ( $t_{ZL}$ )	Figure 8			50	ns
Receiver Disable from Output High ( $t_{HZ}$ )	Figure 8			100	ns
Receiver Disable from Output Low ( $t_{LZ}$ )	Figure 8			200	ns
Receiver Enable from Shutdown to Output High	Figure 8			4000	ns
Receiver Enable from Shutdown to Output Low	Figure 8			4000	ns
Time to Shutdown ( $t_{SHDN}$ )		50	200	600	ns

## DRIVER SWITCHING CHARACTERISTICS

Unless otherwise noted  $V_{CC} = +3.3 \pm 0.3V$ , ambient temperature  $T_{MIN} < T_A < T_{MAX}$ . Typical values are at  $V_{CC} = 3.3$ , ambient temperature  $T_A = +25^\circ C$ .

SP3073E, SP3074E & SP3075E Driver Switching Characteristics					
DRIVER CHARACTERISTICS:	Conditions	Min.	Typ.	Max.	Unit
Data Signaling Rate	Duty Cycle 40 to 60%	500			Kbps
Driver Propagation Delay ( $t_{PHL}$ , $t_{PLH}$ )	$R_L = 54\Omega$ , $C_L = 50pF$ , Figure 2 & 3	180		800	ns
Driver Output Rise/Fall Time ( $t_R$ , $t_F$ )		200		800	ns
Driver Differential Skew ( $t_{PLH} - t_{PHL}$ )				100	ns
Driver Enable to Output High ( $t_{ZH}$ )	$R_L = 500\Omega$ , $C_L = 50pF$ , Figure 4 & 5			2500	ns
Driver Enable to Output Low ( $t_{ZL}$ )				2500	ns
Driver Disable from Output High ( $t_{HZ}$ )				100	ns
Driver Disable from Output Low ( $t_{LZ}$ )				100	ns
Driver Enable from Shutdown to Output High ( $t_{ZH(SHDN)}$ )	Figure 4			4500	ns
Driver Enable from Shutdown to Output Low ( $t_{ZL(SHDN)}$ )	Figure 5			4500	ns
Time to Shutdown ( $t_{SHDN}$ )		50	200	600	ns

## RECEIVER SWITCHING CHARACTERISTICS

Unless otherwise noted  $V_{CC} = +3.3 \pm 0.3V$ , ambient temperature  $T_{MIN} < T_A < T_{MAX}$ . Typical values are at  $V_{CC} = 3.3$ , ambient temperature  $T_A = +25^\circ C$ .

SP3073E, SP3074E & SP3075E Receiver Switching Characteristics					
RECEIVER CHARACTERISTICS:	Conditions	Min.	Typ.	Max.	Unit
Data Signaling Rate	Duty Cycle 40 to 60%	500			Kbps
Receiver Propagation Delay ( $t_{PLH}$ , $t_{PHL}$ )	$C_L = 15pF$ , Figure 6 & 7			200	ns
Propagation Delay Skew ( $t_{PLH}$ , $t_{PHL}$ )				30	ns
Receiver Enable to Output High ( $t_{ZH}$ )	Figure 8			50	ns
Receiver Enable to Output Low ( $t_{ZL}$ )	Figure 8			50	ns
Receiver Disable from Output High ( $t_{HZ}$ )	Figure 8			50	ns
Receiver Disable from Output Low ( $t_{LZ}$ )	Figure 8			50	ns
Receiver Enable from Shutdown to Output High	Figure 8			4000	ns
Receiver Enable from Shutdown to Output Low	Figure 8			4000	ns
Time to Shutdown ( $t_{SHDN}$ )		50	200	600	ns

## DRIVER SWITCHING CHARACTERISTICS

Unless otherwise noted  $V_{CC}=+3.3\pm 0.3V$ , ambient temperature  $T_{min} < T_a < T_{max}$ . Typical values are at  $V_{CC} = 3.3$ , ambient temperature  $T_a = +25^{\circ}C$

SP3076E, SP3077E & SP3078E Driver Switching Characteristics					
DRIVER CHARACTERISTICS:	Conditions	Min.	Typ.	Max.	Unit
Data Signaling Rate	Duty Cycle 40 to 60%	16			Mbps
Driver Propagation Delay ( $t_{PHL}$ , $t_{PLH}$ )	$R_L = 54\Omega$ , $C_L = 50pF$ , Figure 2 & 4			50	ns
Driver Output Rise/Fall Time ( $t_r$ , $t_f$ )				15	ns
Driver Differential Skew ( $t_{PLH} - t_{PHL}$ )				8	ns
Driver Enable to Output High ( $t_{ZH}$ )	$R_L = 500\Omega$ , $C_L = 50pF$ , Figure 4 & 5			150	ns
Driver Enable to Output Low ( $t_{ZL}$ )				150	ns
Driver Disable from Output High ( $t_{HZ}$ )				100	ns
Driver Disable from Output Low ( $t_{LZ}$ )				100	ns
Driver Enable from Shutdown to Output High ( $t_{ZH(SHDN)}$ )	Figure 4			1800	ns
Driver Enable from Shutdown to Output Low ( $t_{ZL(SHDN)}$ )	Figure 5			1800	ns
Time to Shutdown ( $t_{SHDN}$ )		50	200	600	ns

## RECEIVER SWITCHING CHARACTERISTICS

Unless otherwise noted  $V_{CC}=+3.3\pm 0.3V$ , ambient temperature  $T_{min} < T_a < T_{max}$ . Typical values are at  $V_{CC} = 3.3$ , ambient temperature  $T_a = +25^{\circ}C$

SP3076E, SP3077E & SP3078E Receiver Switching Characteristics					
RECEIVER CHARACTERISTICS:	Conditions	Min.	Typ.	Max.	Unit
Data Signaling Rate	Duty Cycle 40 to 60%	16			Mbps
Receiver Propagation Delay ( $t_{PLH}$ , $t_{PHL}$ )	$C_L=15pF$ , Figure 6 & 7, -40 to +85 °C		40	75	ns
Propagation Delay Skew ( $t_{PLH}$ , $t_{PHL}$ )				8	ns
Receiver Enable to Output High ( $t_{ZH}$ )	Figure 8			60	ns
Receiver Enable to Output Low ( $t_{ZL}$ )	Figure 8			60	ns
Receiver Disable from Output High ( $t_{HZ}$ )	Figure 8			50	ns
Receiver Disable from Output Low ( $t_{LZ}$ )	Figure 8			50	ns
Receiver Enable from Shutdown to Output High	Figure 8			3000	ns
Receiver Enable from Shutdown to Output Low	Figure 8			3000	ns
Time to Shutdown ( $t_{SHDN}$ )		50	200	600	ns

FIGURE 1. DRIVER DC TEST CIRCUIT

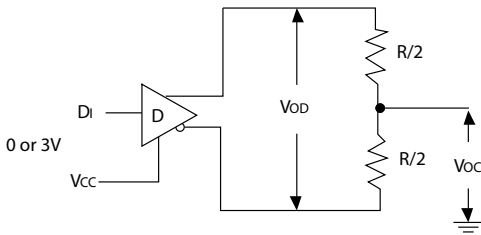

FIGURE 2. RECEIVER DC TEST CIRCUIT

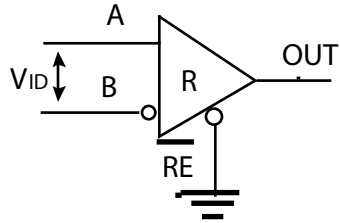
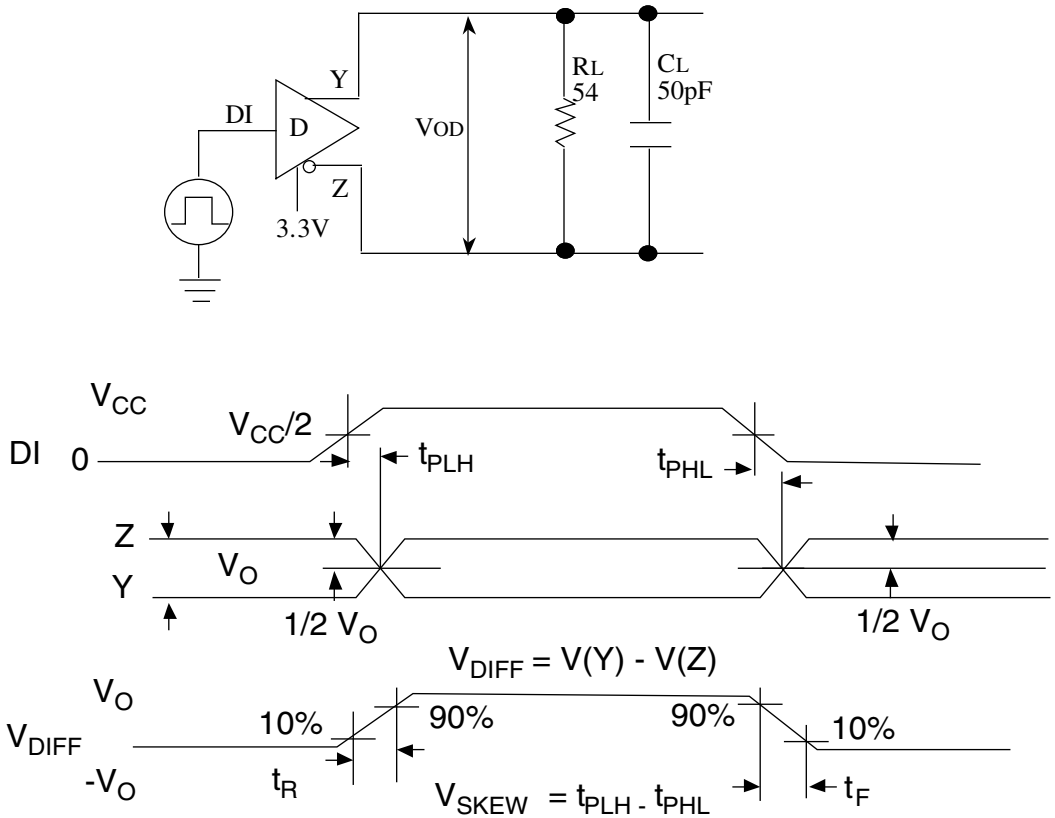

FIGURE 3. DRIVER PROPAGATION DELAY TIME TEST CIRCUIT AND TIMING DIAGRAM

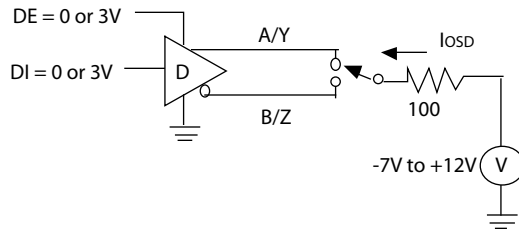



**FIGURE 4. DRIVER ENABLE & DISABLE TIMES TEST CIRCUIT & TIMING DIAGRAM**



**FIGURE 4A. DRIVER CONTENTION TEST**



**FIGURE 5. DRIVER ENABLE & DISABLE TIMES TEST CIRCUIT & TIMING DIAGRAM**



**FIGURE 6. RECEIVER PROPAGATION DELAY TEST CIRCUIT & TIMING DIAGRAM**



**FIGURE 7. RECEIVER ENABLE & DISABLE TIMES TEST CIRCUIT**

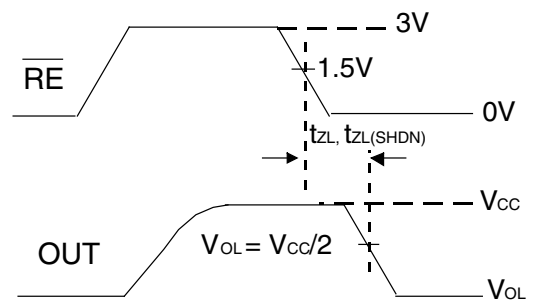

**FIGURE 8. RECEIVER ENABLE & DISABLE TIMING DIAGRAM**

S1 is open S2 is closed S3 = 1.5V



S1 is closed, S2 is open, S3 = -1.5V



S1 is open S2 is closed S3 = 1.5V



S1 is closed, S2 is open, S3 = -1.5V



**FUNCTION TABLES**

SP3070E, SP3073E, SP3076E (Full Duplex)				
TRANSMITTING				
Inputs			Outputs	
$\overline{RE}$	DE	DI	Z	Y
X	1	1	0	1
X	1	0	1	0
0	0	X	High-Z	
1	0	X	Shutdown	

SP3070E, SP3073E, SP3076E (Full Duplex)			
RECEIVING			
Inputs			Output
$\overline{RE}$	DE	A, B	RO
0	X	-50mV	1
0	X	-200mV	0
X	X	Open, Shorted	1
1	1	X	High-Z
1	0	X	Shutdown

SP3071E, SP3074E, SP3077E (Full Duplex)		
TRANSMITTING		
Inputs	Outputs	
DI	Z	Y
1	0	1
0	1	0

SP3071E, SP3074E, SP3077E (Full Duplex)	
RECEIVING	
Inputs	Output
A, B	RO
-50mV	1
-200mV	0
Open/shorted	1

SP3072E, SP3075E, SP3078E (Half Duplex)				
TRANSMITTING				
Inputs			Outputs	
$\overline{RE}$	DE	DI	B/Z	A/Y
X	1	1	0	1
X	1	0	1	0
0	0	X	High-Z	
1	0	X	Shutdown	

SP3072E, SP3075E, SP3078E (Half Duplex)			
RECEIVING			
Inputs			Output
$\overline{RE}$	DE	A, B	RO
0	X	-50mV	1
0	X	-200mV	0
X	X	Open/shorted	1
1	1	X	High-Z
1	0	X	Shutdown

FULL DUPLEX DEVICES		HALF DUPLEX DEVICES	PIN NAME	PIN FUNCTION
SP3070E	SP3071E	SP3072E		
SP3073E	SP3074E	SP3075E		
SP3076E	SP3077E	SP3078E		
PIN NUMBER				
2	2	1	RO	Receiver Output. When $\overline{RE}$ is low and if (A – B) < -50mV, RO is High. If (A – B) > -200mV, RO is low.
3	-	2	$\overline{RE}$	Receiver Output Enable. When $\overline{RE}$ is low, RO is enabled. When RE is high, RO is high impedance. RE should be high and DE low to enter shutdown mode. $\overline{RE}$ is a hot-swap input.
4	-	3	DE	Driver Output Enable. When DE is high, outputs are enabled. When DE is low, outputs are high impedance. DE should be low and $\overline{RE}$ high to enter shutdown mode. DE is a hot-swap input.
5	3	4	DI	Driver Input. With DE high, a low level on DI forces noninverting output low and inverting output high. Similarly, a high level on DI forces noninverting output high and inverting output low.
6, 7	4	5	GND	Ground
9	5	-	Y	Noninverting Driver Output
10	6	-	Z	Inverting Driver Output
11	7	-	B	Inverting Receiver Input
-	-	7	B	Inverting Receiver Input and Inverting Driver Output
12	8	-	A	Noninverting Receiver Input
-	-	6	A	Noninverting Receiver Input and Noninverting Driver Output
14	1	8	$V_{cc}$	Positive Supply $V_{cc}$ . Bypass $V_{cc}$ to GND with a 0.1uF capacitor.
1, 8, 13	-	-	NC	No Connect

**DETAILED DESCRIPTION**

The SP307XE family of high speed transceivers for RS-485/RS-422 communication contain one driver and one receiver. These devices feature fail-safe circuitry, which guarantees a logic-high receiver output when the receiver inputs are open or shorted, or when they are connected to a terminated transmission line with all drivers disabled. The SP3070E, SP3072E, SP3073E, SP3075E, SP3076E and SP3078E also feature a hotswap capability allowing live insertion without error data transfer. The SP3070E, SP3071E and SP3072E feature reduced slew-rate drivers that minimize EMI and reduce reflections caused by improperly terminated cables, allowing error-free data transmission up to 250kbps. The SP3073E, SP3074E and SP3075E also offer slew -rate limits allowing transmit speeds up to 500kbps. The SP3076E, SP3077E, SP3078E driver slew rates are not limited, making transmit speeds up to 16Mbps possible.

The SP3072E, SP3075E and SP3078E are half-duplex transceivers, while the SP3070E, SP3071E, SP3073E, SP3074E, SP3076E, and SP3077E are full duplex transceivers.

All devices operate from a single 3.3V supply. Drivers are output short-circuit current limited. Thermal-shutdown circuitry protects drivers against excessive power dissipation. When activated, the thermal-shutdown circuitry places the driver outputs into a high-impedance state.

**RECEIVER INPUT FILTERING**

SP3070E-SP3075E receivers incorporate input filtering in addition to input hysteresis. This filtering enhances noise immunity with differential signals that have very slow rise and fall times. Receiver propagation delay increases by 25% due to this filtering.

**FAIL SAFE**

The SP3070E family guarantees a logic-high receiver output when the receiver inputs are shorted, open, or when they are connected to a terminated transmission line with all drivers disabled. If A - B is less than or equal

to -200mV, RO is logic low. In the case of a terminated bus with all transmitters disabled the receiver's differential input voltage is pulled to ZeroV by the termination. With the receiver thresholds of the SP3070E family, this results in a logic high with a 50mV minimum noise margin. In compliance with the EIA/TIA-485 standard, the SP3070E family has a 50mV - 200mV threshold.

**HOT-SWAP CAPABILITY**

When circuit boards are inserted into a hot backplane, differential disturbances to the data bus can lead to data errors. Upon initial circuit board insertion, the data communication processor undergoes its own power-up sequence. During this period, the processor's logic-output drivers are high impedance and are unable to drive the DE and RE inputs of these devices to a defined logic level. Leakage currents up to 10 $\mu$ A from the high-impedance state of the processor's logic drivers could cause standard CMOS enable inputs of a transceiver to drift to an incorrect logic level. Additionally, parasitic circuit board capacitance could cause coupling of VCC or GND to the enable inputs. Without the hot-swap capability, these factors could improperly enable the transceiver's driver or receiver.

When VCC rises, an internal pulldown circuit holds DE low and RE high for approximately 10 microseconds. After the initial power-up sequence, the pulldown circuit becomes transparent, resetting the hot-swap tolerable input.

**15KV ESD PROTECTION**

As with all Exar devices, ESD-protection structures are incorporated on all pins to protect against electrostatic discharges encountered during handling and assembly. The driver output and receiver inputs of the SP3070E family of devices have extra protection against static electricity. Exar's engineering team have developed state of the art structures to protect these pins against ESD of 15kV without damage. The

ESD structures withstand high ESD in all states: normal operation, shutdown, and powered down. After an ESD event, the SP3070E - SP3078E keep working without latchup or damage.

ESD protection can be tested in various ways. The transmitter outputs and receiver inputs of the SP3070E - SP3078E are characterized for protection to the following limits:

- ±15kV using the Human Body Model
- ±8kV using the Contact Discharge method specified in IEC 61000-4-2
- ±15kV Airgap

### ESD TEST CONDITIONS

ESD performance depends on a variety of conditions. Contact Exar for a reliability report that documents test setup, methodology and results.

### IEC 61000-4-2

The IEC 61000-4-2 standard covers ESD testing and performance of finished equipment. However, it does not specifically refer to integrated circuits. The SP3070E family of devices helps you design equipment to meet IEC 61000-4-2, without the need for additional ESD-protection components.

The major difference between tests done using the Human Body Model and IEC 61000-4-2 is higher peak current in IEC 61000-4-2, because series resistance is lower in the IEC 1000-4-2 model. Hence, the ESD withstand voltage measured to EC 61000-4-2 is generally lower than that measured using the human body model.

The air-gap test involves approaching the device with a charged probe. The contact-discharge method connects the probe to the device before the probe is energized.

### MACHINE MODEL

The machine model for ESD tests all pins using a 200pF storage capacitor and zero discharge resistance. The objective is to emulate the stress caused when I/O pins are contacted by handling equipment during test and assembly.

### 256 TRANSCEIVERS ON THE BUS

The standard RS-485 receiver input impedance is 12k $\Omega$  (1 unit load), and the standard driver can drive up to 32 unit loads. The SP3070E family of transceivers has a 1/8-unit load receiver input impedance (96k $\Omega$ ), allowing up to 256 transceivers to be connected in parallel on one communication line. Any combination of these devices as well as other RS-485 transceivers with a total of 32 unit loads or fewer can be connected to the line.

### REDUCED EMI AND REFLECTIONS

The SP3070E, SP3071E and SP3072E feature reduced slew-rate drivers that minimize EMI and reduce reflections caused by improperly terminated cables, allowing error-free data transmission up to 250kbps. The SP3073E, SP3074E and SP3075E offer higher driver output slew-rate limits, allowing transmit speeds up to 500kbps.

### LOW POWER SHUTDOWN MODE

Low-power shutdown mode is initiated by bringing both  $\overline{RE}$  high and DE low. In shutdown, the devices typically draw only 50nA of supply current.

$\overline{RE}$  and DE can be driven simultaneously; the parts are guaranteed not to enter shutdown if  $\overline{RE}$  is high and DE is low for less than 50ns. If the inputs are in this state for at least 600ns, the parts are guaranteed to enter shutdown.

Enable times  $t_{ZH}$  and  $t_{ZL}$  assume the part was not in a low-power shutdown state. Enable times  $t_{ZH(SHDN)}$  and  $t_{ZL(SHDN)}$  assume the parts were shut down. It takes drivers and receivers longer to become enabled from low-power shutdown mode  $t_{ZH(SHDN)}$  and  $t_{ZL(SHDN)}$  than from driver/receiver-disable mode ( $t_{ZH}$ ,  $t_{ZL}$ )

### DRIVER OUTPUT PROTECTION

Two mechanisms prevent excessive output current and power dissipation caused by faults or by bus contention. First, current limit on the output stage, provides immediate protection against short circuits over the whole common-mode voltage range.

---

## DETAILED DESCRIPTION

Second, a thermal-shutdown circuit, forces the driver outputs into a high-impedance state if the die temperature becomes excessive.

### LINE LENGTH

The RS-485/RS422 standard covers line lengths up to 4000ft.

### TYPICAL APPLICATIONS

The SP3072E, SP3075E and SP3078E transceivers are designed for bidirectional data communications on multipoint bus transmission lines.

To minimize reflections, terminate the line at both ends in its characteristic impedance, and keep stub lengths off the main line as short as possible. The slew-rate-limited SP3070E - SP3075E are more tolerant of imperfect termination.

---

## PARTS SELECTOR GUIDE

PART NUMBER	Half/Full Duplex	Datarate Mbps	Shut-down	Receiver Driver Enable	Trans. On Bus	Pin Count	Industry Standard Pinout	Pin Compatible Upgrade from:
SP3070E	Full	0.25	Yes	Yes	256	14	MAX3070E, 75180	
SP3071E	Full	0.25	No	No	256	8	MAX 3071E, 75179	SP3493
SP3072E	Half	0.25	Yes	Yes	256	8	MAX 3072E, 75176	SP3483
SP3073E	Full	0.5	Yes	Yes	256	14	MAX 3073E, 75180	
SP3074E	Full	0.5	No	No	256	8	MAX 3074E, 75179	
SP3075E	Half	0.5	Yes	Yes	256	8	MAX 3075E, 75176	SP3494
SP3076E	Full	16	Yes	Yes	256	14	MAX 3076E, 75180	SP3491
SP3077E	Full	16	No	No	256	8	MAX3077E, 75179	SP3490
SP3078E	Half	16	Yes	Yes	256	8	MAX 3078E, 75176	SP3485, SP3481



REVISION HISTORY			
REV.	DESCRIPTION	DATE	APP'D
A	DRAWING ORIGINATOR	08/16/05	JL
B	DRAWING FORMAT MODIFICATION	07/19/06	JL
C	CHANGE DRAWING LOGO AND COMPANY NAME	11/16/07	JL

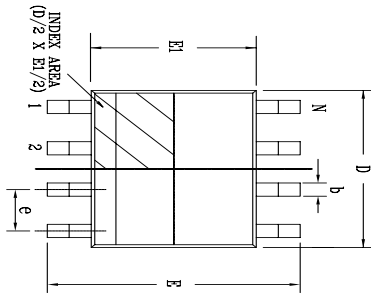

Top View

8 PIN SOICN JEDEC MS-012 Variation AA		DIMENSIONS IN MM (Control Unit)		DIMENSIONS IN INCH (Reference Unit)	
SYMBOLS	MIN	NOM	MAX	MIN	MAX
A	1.55	—	1.75	0.053	—
A1	0.10	—	0.25	0.004	—
A2	1.25	—	1.85	0.049	—
b	0.31	—	0.51	0.012	—
c	0.17	—	0.25	0.007	—
E	6.00	BSC	—	0.236	BSC
E1	3.90	BSC	—	0.154	BSC
e	1.27	BSC	—	0.050	BSC
h	0.25	—	0.50	0.010	—
L	0.40	—	1.27	0.016	—
L1	—	1.04	REF	—	0.041
L2	—	0.25	BSC	—	0.010
R	0.07	—	—	0.003	—
R1	0.07	—	—	0.003	—
θ	0°	—	—	8°	—
θ1	5°	—	—	15°	—
θ2	0°	—	—	0°	—
D	—	4.90	BSC	—	0.193
N	—	8	—	—	8

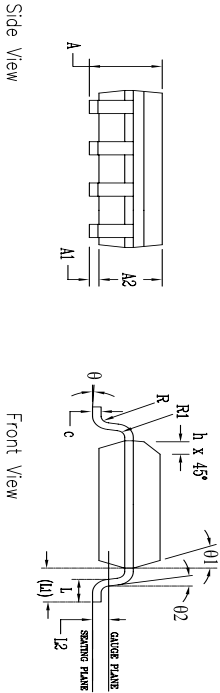

Side View

Front View

		<b>EXAR CORPORATION</b>	
		8 PIN SOICN PACKAGE OUTLINE	
Packaging Approval:	Drawing No:	8-PIN SOICN	
Br: JL Date: 11/16/07	Revision: C	Sheet: 1 OF 1	

REVISION HISTORY			
REV.	DESCRIPTION	DATE	APP'D
A	DRAWING ORIENTATION	04/17/06	JL
B	CHANGE DRAWING LOGO AND COMPANY NAME	11/27/07	JL

14 Pin SOICN		JEDEC MS-012		Variation AB		
SYMBOLS	DIMENSIONS IN MM (Control Unit)			DIMENSIONS IN INCH (Reference Unit)		
	MIN	NOM	MAX	MIN	NOM	MAX
A	1.35	—	1.75	0.053	—	0.069
A1	0.10	—	0.25	0.004	—	0.010
A2	1.25	—	1.65	0.049	—	0.065
b	0.31	—	0.51	0.012	—	0.020
c	0.17	—	0.25	0.007	—	0.010
E	6.00	BSC	—	0.236	BSC	—
E1	3.90	BSC	—	0.154	BSC	—
e	1.27	BSC	—	0.050	BSC	—
h	0.25	—	0.50	0.010	—	0.020
L	0.40	—	1.27	0.016	—	0.050
L1	—	1.04	REF	—	0.041	REF
L2	—	0.25	BSC	—	0.010	BSC
R	0.07	—	—	0.003	—	—
R1	0.07	—	—	0.003	—	—
θ	0°	—	8°	0°	—	8°
θ1	5°	—	15°	5°	—	15°
θ2	0°	—	—	0°	—	—
D	—	8.65	BSC	—	0.341	BSC
N	—	14	—	—	14	—



Top View

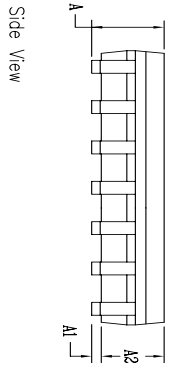

Side View



Front View

 EXAR CORPORATION Precision Components		EXAR CORPORATION 14 PIN SOICN PACKAGE OUTLINE	
Packaging Approval: JL Date: 11/21/07	Drawing No: B Revision: 1	14-PIN SOICN	Sheet: 1 of 1

Model	Temperature Range	Package
SP3070EEN-L	-40°C to +85°C	14-pin NSOIC
SP3070EEN-L/TR	-40°C to +85°C	14-pin NSOIC
SP3070EMN-L	-40°C to +125°C	14-pin NSOIC
SP3070EMN-L/TR	-40°C to +125°C	14-pin NSOIC
SP3071EEN-L	-40°C to +85°C	8-pin NSOIC
SP3071EEN-L/TR	-40°C to +85°C	8-pin NSOIC
SP3071EMN-L	-40°C to +125°C	8-pin NSOIC
SP3071EMN-L/TR	-40°C to +125°C	8-pin NSOIC
SP3072EEN-L	-40°C to +85°C	8-pin NSOIC
SP3072EEN-L/TR	-40°C to +85°C	8-pin NSOIC
SP3072EMN-L	-40°C to +125°C	8-pin NSOIC
SP3072EMN-L/TR	-40°C to +125°C	8-pin NSOIC
SP3073EEN-L	-40°C to +85°C	14-pin NSOIC
SP3073EEN-L/TR	-40°C to +85°C	14-pin NSOIC
SP3073EMN-L	-40°C to +125°C	14-pin NSOIC
SP3073EMN-L/TR	-40°C to +125°C	14-pin NSOIC
SP3074EEN-L	-40°C to +85°C	8-pin NSOIC
SP3074EEN-L/TR	-40°C to +85°C	8-pin NSOIC
SP3074EMN-L	-40°C to +125°C	8-pin NSOIC
SP3074EMN-L/TR	-40°C to +125°C	8-pin NSOIC
SP3075EEN-L	-40°C to +85°C	8-pin NSOIC
SP3075EEN-L/TR	-40°C to +85°C	8-pin NSOIC
SP3075EMN-L	-40°C to +125°C	8-pin NSOIC
SP3075EMN-L/TR	-40°C to +125°C	8-pin NSOIC
SP3076EEN-L	-40°C to +85°C	14-pin NSOIC
SP3076EEN-L/TR	-40°C to +85°C	14-pin NSOIC
SP3076EMN-L	-40°C to +125°C	14-pin NSOIC
SP3076EMN-L/TR	-40°C to +125°C	14-pin NSOIC
SP3077EEN-L	-40°C to +85°C	8-pin NSOIC
SP3077EEN-L/TR	-40°C to +85°C	8-pin NSOIC
SP3077EMN-L	-40°C to +125°C	8-pin NSOIC
SP3077EMN-L/TR	-40°C to +125°C	8-pin NSOIC
SP3078EEN-L	-40°C to +85°C	8-pin NSOIC
SP3078EEN-L/TR	-40°C to +85°C	8-pin NSOIC
SP3078EMN-L	-40°C to +125°C	8-pin NSOIC
SP3078EMN-L/TR	-40°C to +125°C	8-pin NSOIC

For availability of PDIP or other packaging contact factory.

Available in lead free packaging. To order add "-L" suffix to part number.

Example: SP3074EEN/TR = standard; SP3074EEN-L/TR = lead free

/TR = Tape and Reel

Pack quantity is 2,500 for NSOIC.

DATE	REVISION	DESCRIPTION
		Legacy Sipex Datasheet
06/10/09	1.0.0	Convert to Exar format, update ordering information, correct subscript on pages 5-7 and change revision to 1.0.0
09/30/10	1.0.1	Correct type error on page 7 on driver switching characteristics table. Change SP3076E,3077E and 3078E Receiver enable time from shutdown from 1800ns to 3000ns.
12/02/10	1.0.2	Add reference to Application Note ANI#21 and change ESD protection levels to IEC 61000-4-2.

---

Notice

EXAR Corporation reserves the right to make changes to any products contained in this publication in order to improve design, performance or reliability. EXAR Corporation assumes no representation that the circuits are free of patent infringement. Charts and schedules contained herein are only for illustration purposes and may vary depending upon a user's specific application. While the information in this publication has been carefully checked; no responsibility, however, is assumed for inaccuracies.

EXAR Corporation does not recommend the use of any of its products in life support applications where the failure or malfunction of the product can reasonably be expected to cause failure of the life support system or to significantly affect its safety or effectiveness. Products are not authorized for use in such applications unless EXAR Corporation receives, in writing, assurances to its satisfaction that: (a) the risk of injury or damage has been minimized ; (b) the user assumes all such risks; (c) potential liability of EXAR Corporation is adequately protected under the circumstances.

Copyright 2010 EXAR Corporation

Datasheet December 2010

For technical support please email Exar's Serial Technical Support group at: [serialtechsupport@exar.com](mailto:serialtechsupport@exar.com)

Reproduction, in part or whole, without the prior written consent of EXAR Corporation is prohibited.