

QTLP600C-RY Red/Yellow

QTLP600C-RAG Red/Yellow-Green

PACKAGE DIMENSIONS

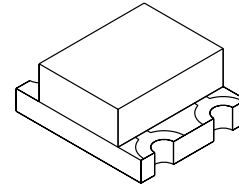
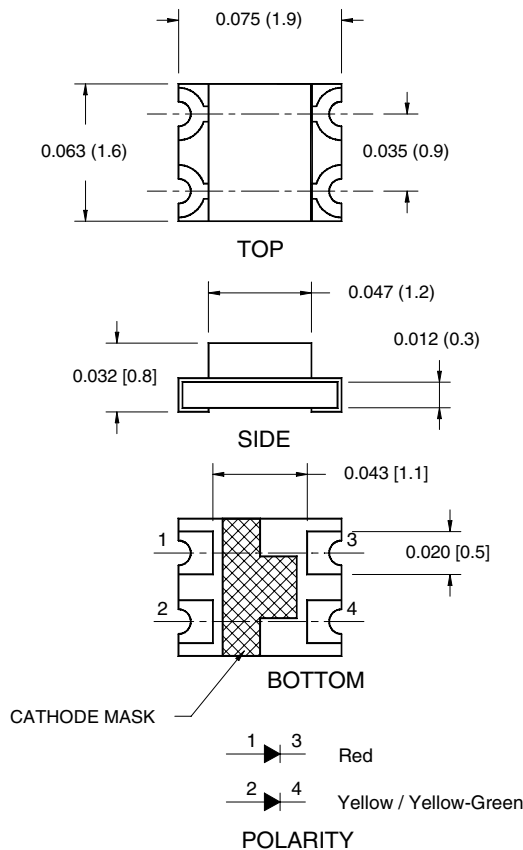

NOTE:

Dimensions for all drawings are in inches (mm).

APPLICATIONS

- Keypad backlighting
- Push-button backlighting
- LCD backlighting

DESCRIPTION

These super bright bi-color surface mount chip LEDs are designed to fit industry standard footprint. Small size, low profile and wide viewing angle make these LEDs ideal for backlighting applications and panel illumination.

FEATURES

- Miniature footprint - 1.9(L) X 1.6(W) X 0.8(H) mm
- AllnGaP technology
- Wide viewing angle of 130°
- Water clear optics
- Moisture-proof packaging
- Available in 0.315" (8mm) width tape on 7" (178mm) diameter reel; 2,000 units per reel

QTLP600C-RY Red/Yellow

QTLP600C-RAG Red/Yellow-Green

ABSOLUTE MAXIMUM RATINGS (T_A =25°C Unless otherwise specified)

Parameter	Symbol	QTLP600C		Units
		-RY	-RAG	
Continuous Forward Current	I _F	30 / 25	30 / 30	mA
Peak Forward Current (f = 1.0 KHz, Duty Factor = 1/10)	I _{FM}	160 / 120	160 / 160	mA
Reverse Voltage	V _R	5	5	V
Power Dissipation	P _D	72 / 60	72 / 72	mW
Operating Temperature	T _{OPR}	-40 to +85		°C
Storage Temperature	T _{STG}	-40 to +90		°C
Lead Soldering Time	T _{SOL}	260 for 5 sec		°C

ELECTRICAL / OPTICAL CHARACTERISTICS (T_A =25°C)

Parameter	Symbol	QTLP600C		Units
		-RY	-RAG	
Luminous Intensity (mcd)	I _V	10 / 10	10 / 8	I _F = 20mA
Minimum				
Typical		30 / 30	30 / 15	
Forward Voltage (V)	V _F	2.4 / 2.4	2.4 / 2.4	I _F = 20mA
Maximum				
Typical		2.0 / 2.0	2.0 / 2.0	
Wavelength (nm)	λ _P	630 / 590	630 / 575	I _F = 20mA
Peak				
Dominant	λ _D	624 / 589	624 / 573	
Spectral Line Half Width (nm)	Δλ	20 / 15	20 / 20	I _F = 20mA
Viewing Angle (°)	2Θ _{1/2}	130	130	I _F = 20mA

TYPICAL PERFORMANCE CURVES

Fig. 1 Forward Current vs. Forward Voltage

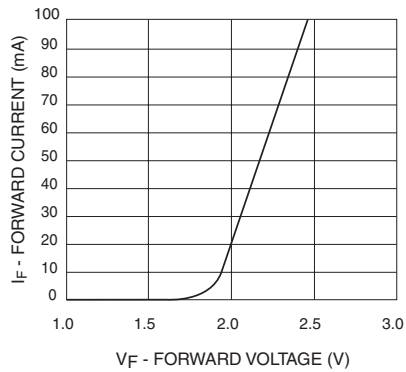

Fig. 2 Relative Luminous Intensity vs. DC Forward Current

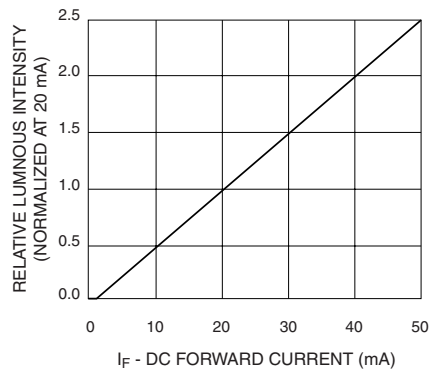

Fig. 3 Relative Intensity vs. Peak Wavelength

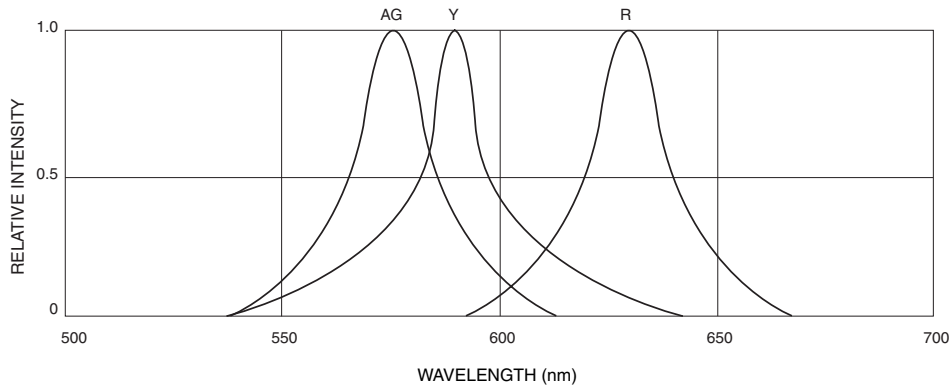

Fig.4 Radiation Diagram

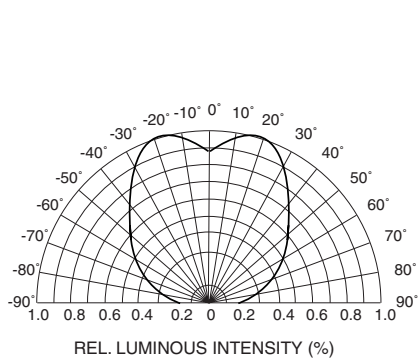
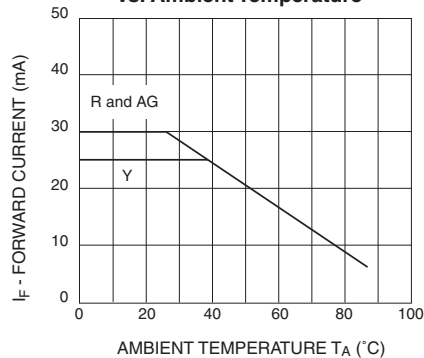

Fig.5 Maximum Forward Current vs. Ambient Temperature



QTLP600C-RY Red/Yellow

QTLP600C-RAG Red/Yellow-Green

RECOMMENDED PRINTED CIRCUIT BOARD PATTERN

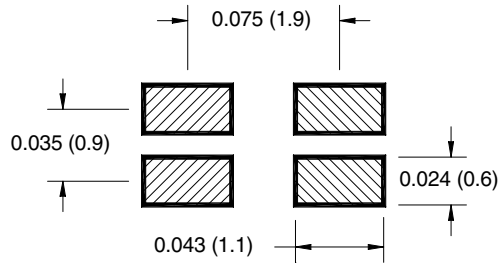

RECOMMENDED IR REFLOW SOLDERING PROFILE

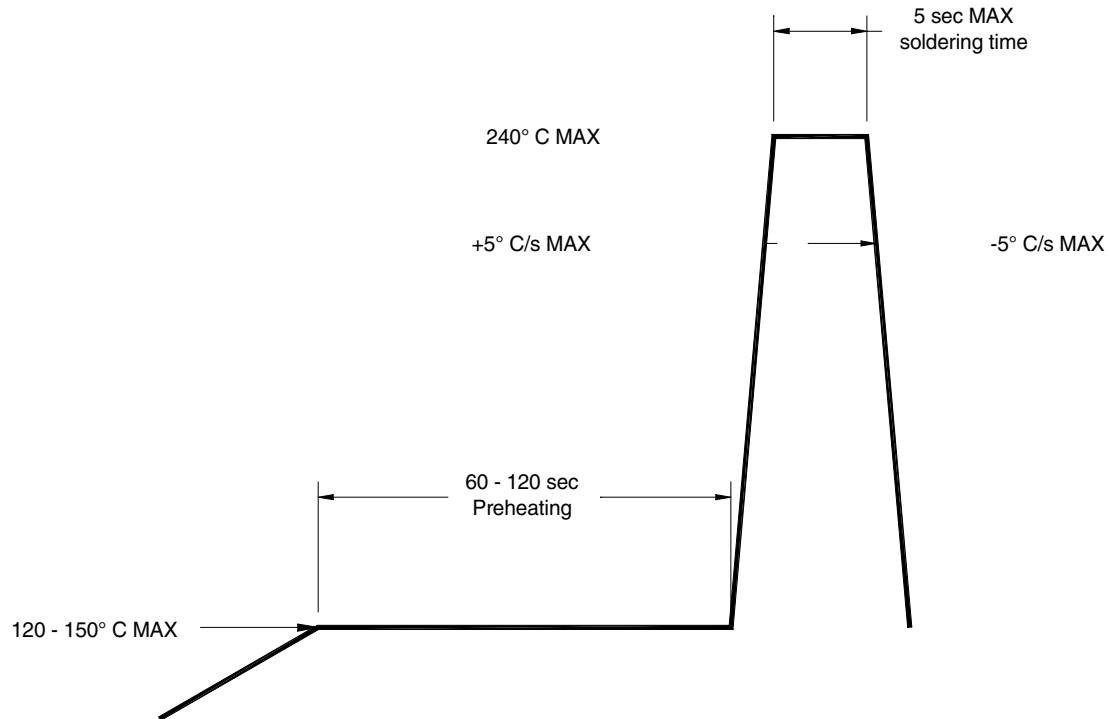

TAPE AND REEL DIMENSIONS

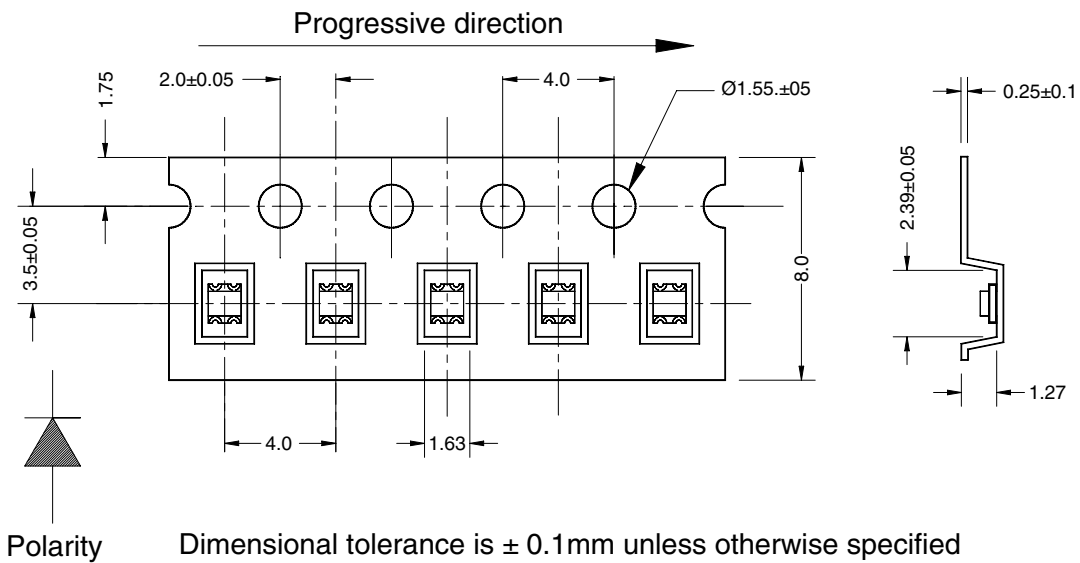
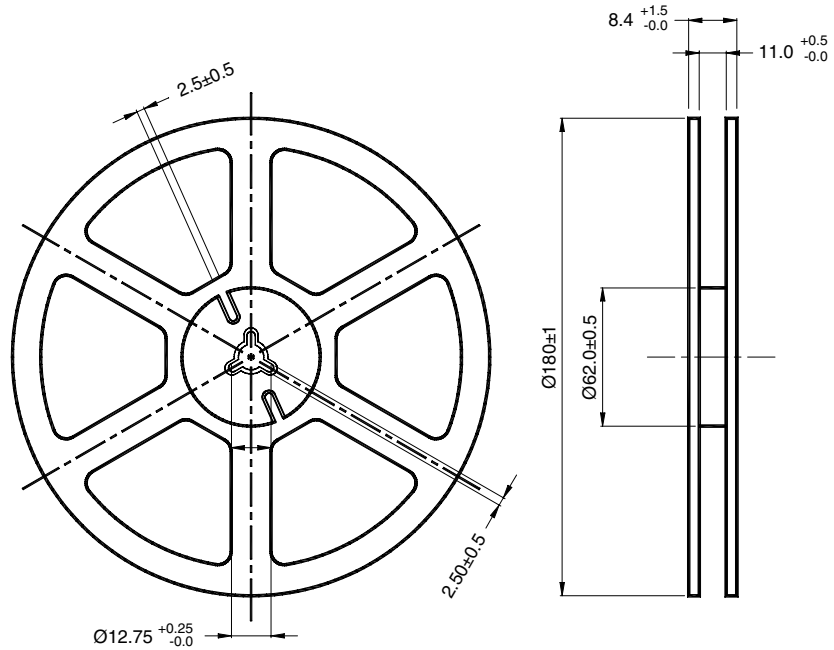

Polarity

Dimensional tolerance is ± 0.1 mm unless otherwise specified

Angle: ± 0.5

Unit: mm

QTLP600C-RY Red/Yellow

QTLP600C-RAG Red/Yellow-Green

DISCLAIMER

FAIRCHILD SEMICONDUCTOR RESERVES THE RIGHT TO MAKE CHANGES WITHOUT FURTHER NOTICE TO ANY PRODUCTS HEREIN TO IMPROVE RELIABILITY, FUNCTION OR DESIGN. FAIRCHILD DOES NOT ASSUME ANY LIABILITY ARISING OUT OF THE APPLICATION OR USE OF ANY PRODUCT OR CIRCUIT DESCRIBED HEREIN; NEITHER DOES IT CONVEY ANY LICENSE UNDER ITS PATENT RIGHTS, NOR THE RIGHTS OF OTHERS.

LIFE SUPPORT POLICY

FAIRCHILD'S PRODUCTS ARE NOT AUTHORIZED FOR USE AS CRITICAL COMPONENTS IN LIFE SUPPORT DEVICES OR SYSTEMS WITHOUT THE EXPRESS WRITTEN APPROVAL OF THE PRESIDENT OF FAIRCHILD SEMICONDUCTOR CORPORATION. As used herein:

1. Life support devices or systems are devices or systems which, (a) are intended for surgical implant into the body, or (b) support or sustain life, and (c) whose failure to perform when properly used in accordance with instructions for use provided in labeling, can be reasonably expected to result in a significant injury of the user.
2. A critical component in any component of a life support device or system whose failure to perform can be reasonably expected to cause the failure of the life support device or system, or to affect its safety or effectiveness.