

Technical Data Sheet

Full Color Top View LEDs

67-03/RSGHBHC-B06/1T

Features

- P-LCC-4 package.
- White package and black surface.
- Colorless clear window.
- Ideal for backlight and light pipe application.
- Inter reflector.
- Wide viewing angle.
- Suitable for vapor-phase reflow, Infrared reflow and wave solder processes.
- Computable with automatic placement equipment.
- Available on tape and reel (8mm Tape).
- Pb-free.
- The product itself will remain with RoHS compliant version

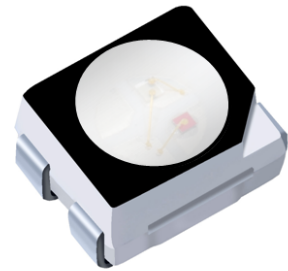

Descriptions

- The 67-03 series is available in soft orange, green, blue and yellow. Due to the package design, the LED has wide viewing angle and optimized light coupling by inter reflector. This feature makes the LED ideal for light pipe application. The low current requirement makes this device ideal for portable equipment or any other application where power is at a premium.

Applications

- Telecommunication: indicator and backlighting in telephone and fax.
- Flat backlight for LCD's, switches and symbols.
- Light pipe application.
- General use.

Device Selection Guide

Chip		Emitted Color	Resin Color
Type	Material		
RS	AlGaInP	Brilliant Red	Water Clear
GH	InGaN	Brilliant Green	
BH	InGaN	Blue	

Technical Data Sheet

Full Color Top View LEDs

67-03/RSGHBHC-B06/1T

Package Outline Dimensions

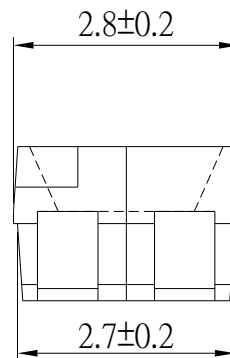
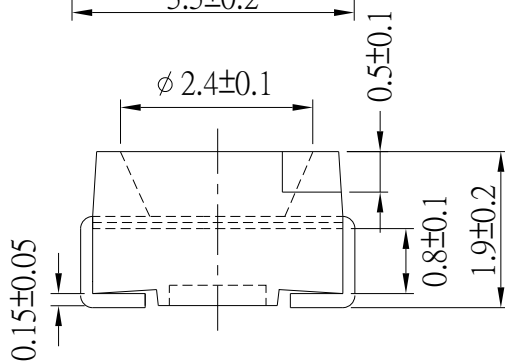
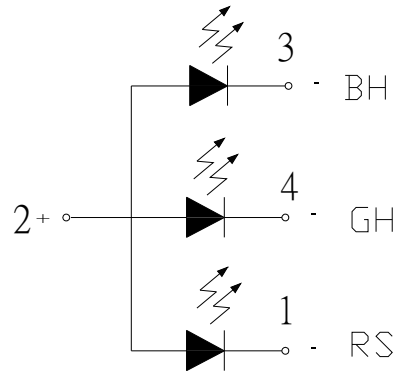
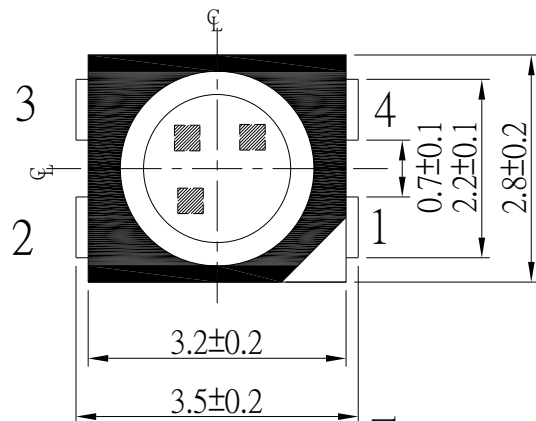

For reflow soldering(propose)

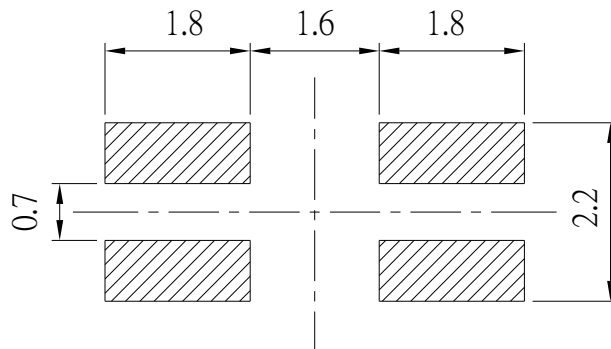
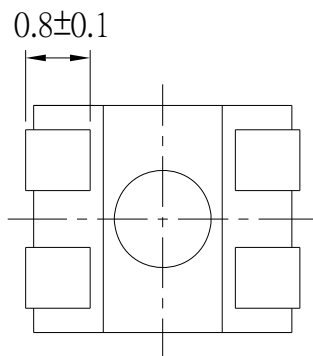

- Notes:** 1.All dimensions are in millimeters
2.Tolerances unless dimension = ±0.1mm

Technical Data Sheet

Full Color Top View LEDs

67-03/RSGHBHC-B06/1T

Absolute Maximum Ratings (Ta=25°C)

Parameter	Symbol	Rating	Unit
Reverse Voltage	V_R	5	V
Forward Current	I_F	RS	50
		GH	30
		BH	30
Peak Forward Current (Duty 1/10 @ 1KHz)	I_{FP}	RS	100
		GH	100
		BH	100
Power Dissipation	P_d	RS	120
		GH	110
		BH	110
Total Power Dissipation	P_{tot}	340	mw
Electrostatic Discharge(HBM)	ESD	RS	2000
		GH	1000
		BH	1000
Operating Temperature	T_{opr}	-40 ~ +85	°C
Storage Temperature	T_{stg}	-40~ +90	°C
Soldering Temperature	T_{sol}	Reflow Soldering : 260 °C for 10 sec. Hand Soldering : 350 °C for 3 sec.	

Technical Data Sheet
Full Color Top View LEDs
67-03/RSGHBHC-B06/1T
Electro-Optical Characteristics (Ta=25°C)

Parameter	Symbol	Min.	Typ.	Max.	Unit	Condition	
Luminous Intensity	I _v	RS	450	-----	715	mcd	I _F =20mA
		GH	900	-----	1420		
		BH	225	-----	450		
Viewing Angle	2θ _{1/2}	-----	120	-----	deg	I _F =20mA	
Peak Wavelength	λ _p	RS	-----	632	-----	nm	I _F =20mA
		GH	-----	518	-----		
		BH	-----	468	-----		
Dominant Wavelength	λ _d	RS	617	-----	627	nm	I _F =20mA
		GH	520	-----	530		
		BH	465	-----	470		
Spectrum Radiation Bandwidth	Δλ	RS	-----	20	-----	nm	I _F =20mA
		GH	-----	35	-----		
		BH	-----	35	-----		
Forward Voltage	V _F	RS	-----	2.0	2.4	V	I _F =20mA
		GH	-----	3.5	4.0		
		BH	-----	3.5	4.0		

Notes:

1. Tolerance of Luminous Intensity: ±11%
2. Tolerance of Dominant Wavelength: ±1 nm

Technical Data Sheet

Full Color Top View LEDs

67-03/RSGHBHC-B06/1T

Bin Range of Luminous Intensity

Symbol		Bin Code	Min.	Max.	Unit	Condition
I _v	RS	U1	450	565	mcd	I _F =20mA
		U2	565	715		
	GH	V2	900	1120		
		W1	1120	1420		
	BH	S2	225	285		
		T1	285	360		
		T2	360	450		

Bin Range of Dominant Wavelength

Symbol		Bin Code	Min.	Max.	Unit	Condition
λ _d	RS	1	617	622	nm	I _F =20mA
		2	622	627		
	GH	X	520	525		
		Y	525	530		
	BH	X	465	470		

Notes:

1. Tolerance of Luminous Intensity: ±11%
2. Tolerance of Dominant Wavelength: ±1 nm

Technical Data Sheet
Full Color Top View LEDs

67-03/RSGHBHC-B06/1T

Typical Electro-Optical Characteristics Curves (RS)

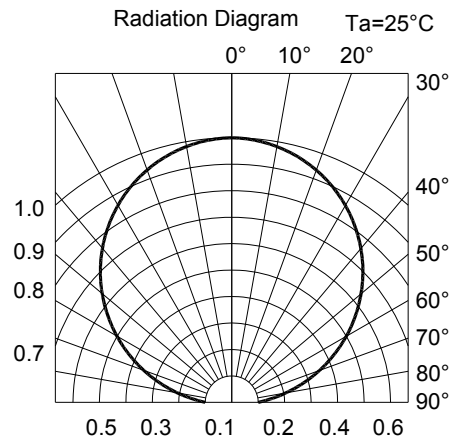
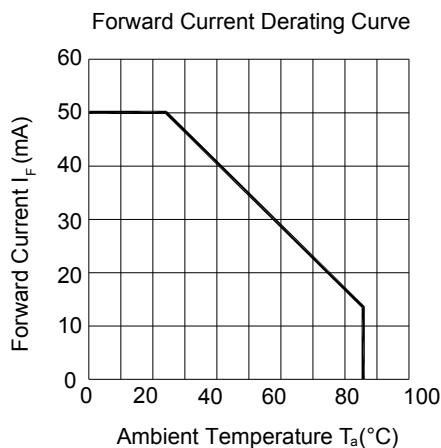
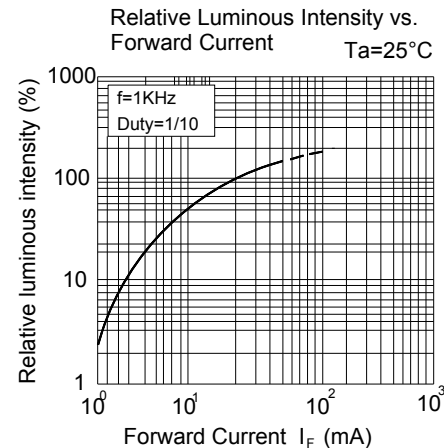
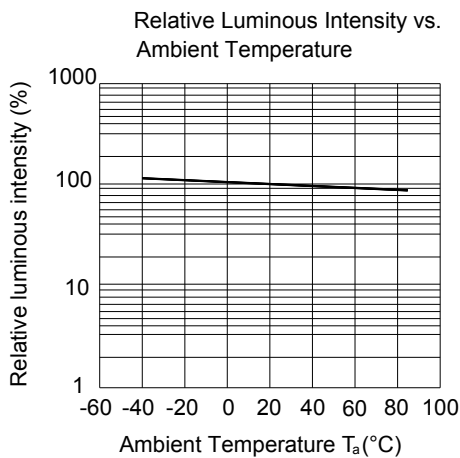
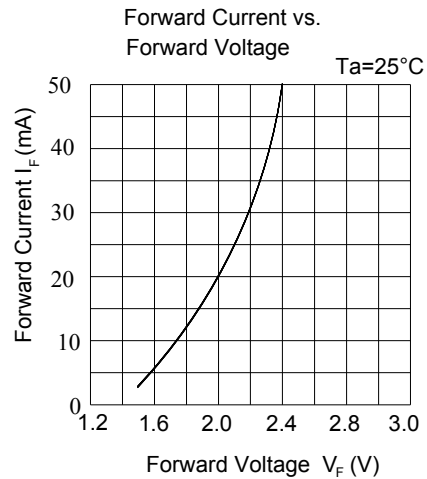
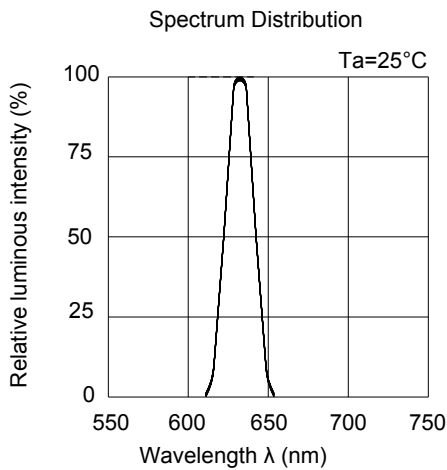

Technical Data Sheet
Full Color Top View LEDs

67-03/RSGHBHC-B06/1T

Typical Electro-Optical Characteristics Curves (GH)

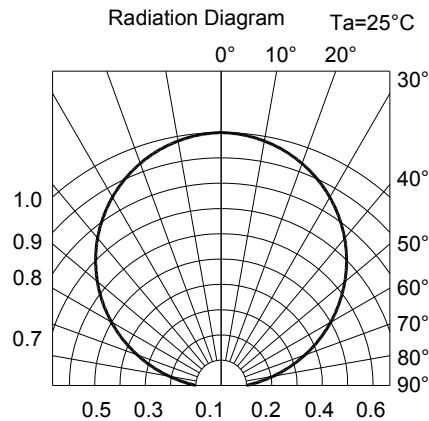
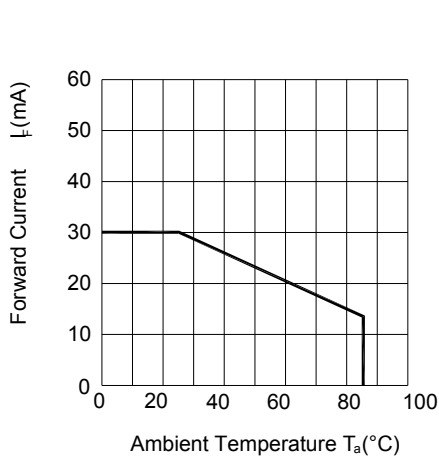
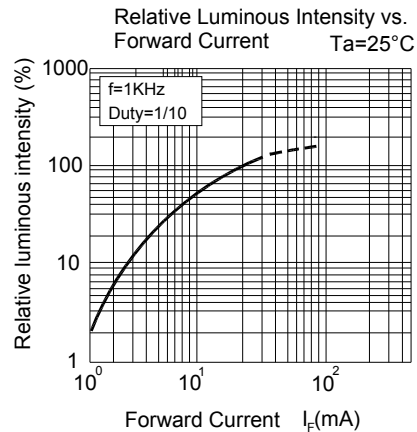
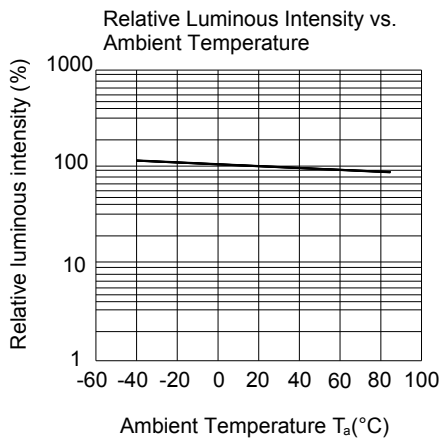
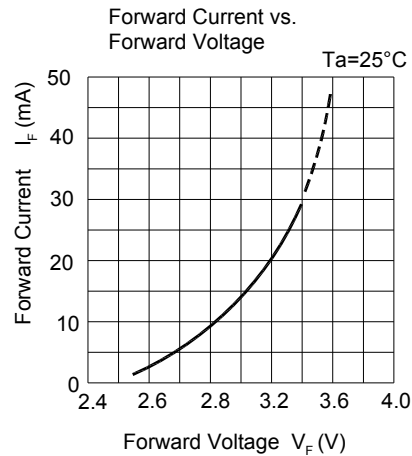
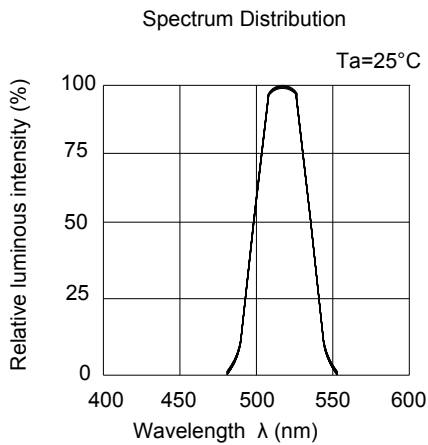

Technical Data Sheet
Full Color Top View LEDs

67-03/RSGHBHC-B06/1T

Typical Electro-Optical Characteristics Curves (BH)

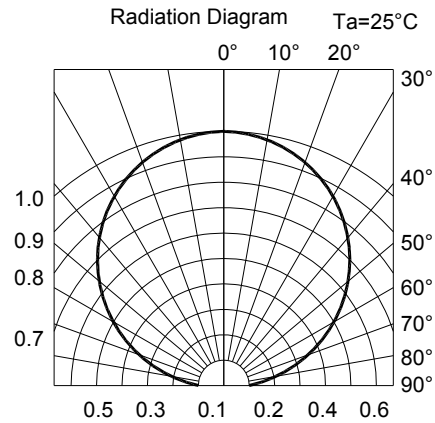
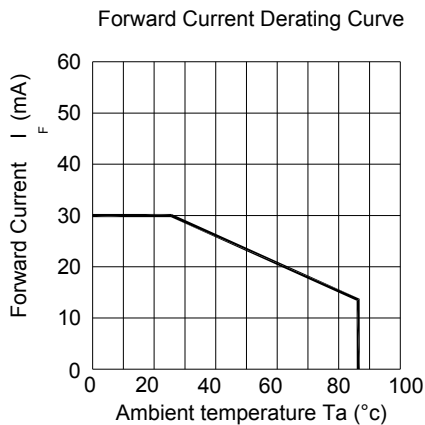
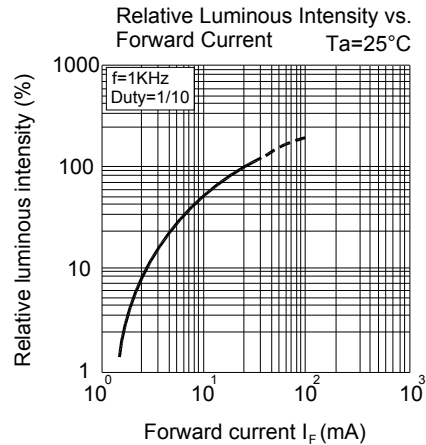
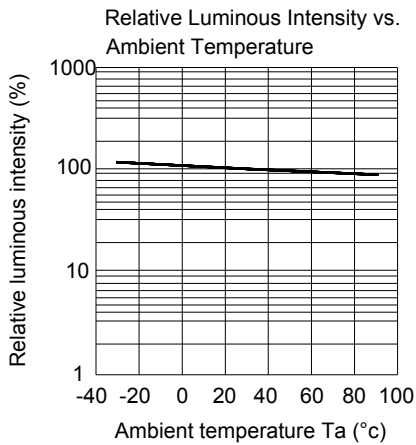
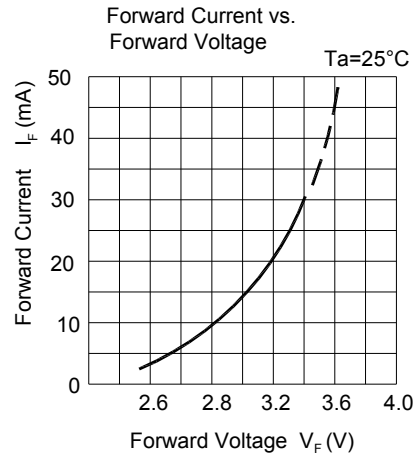
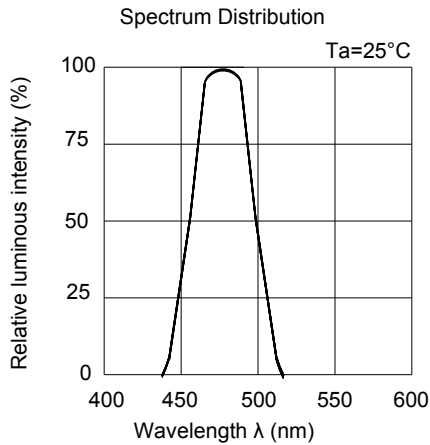

Technical Data Sheet
Full Color Top View LEDs

67-03/RSGHBHC-B06/1T

Label Explanation

CAT: Luminous Intensity Rank

HUE: Dom. Wavelength Rank

REF: Forward Voltage Rank



Reel Dimensions

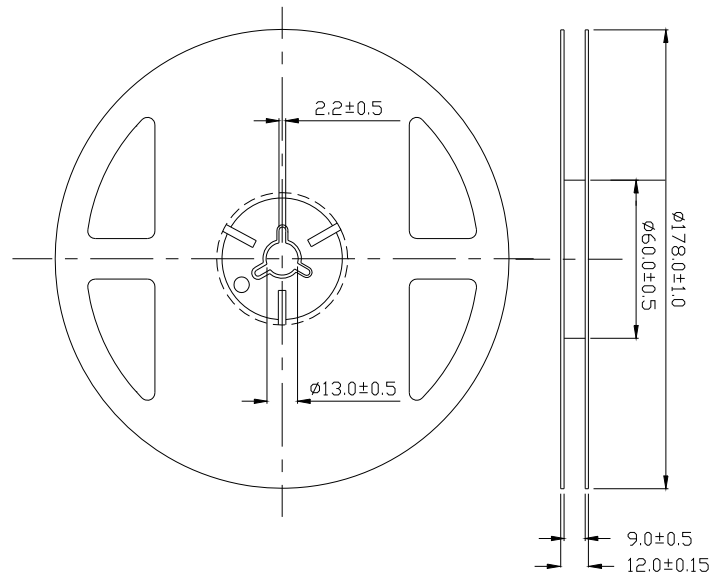

Note: Tolerances unless dimension ± 0.1 mm; Unit = mm

Technical Data Sheet

Full Color Top View LEDs

67-03/RSGHBHC-B06/1T

Carrier Tape Dimensions: Loaded quantity 1000 PCS per reel.

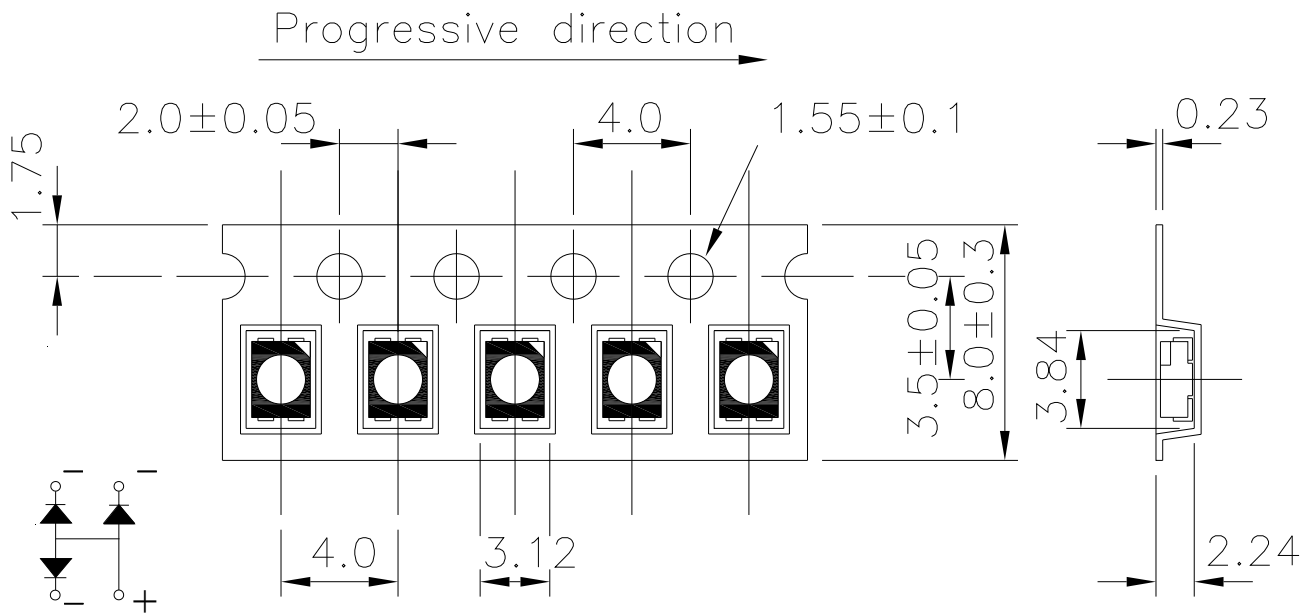

Note: Tolerances unless dimension $\pm 0.1\text{mm}$; Unit = mm

Moisture Resistant Packaging

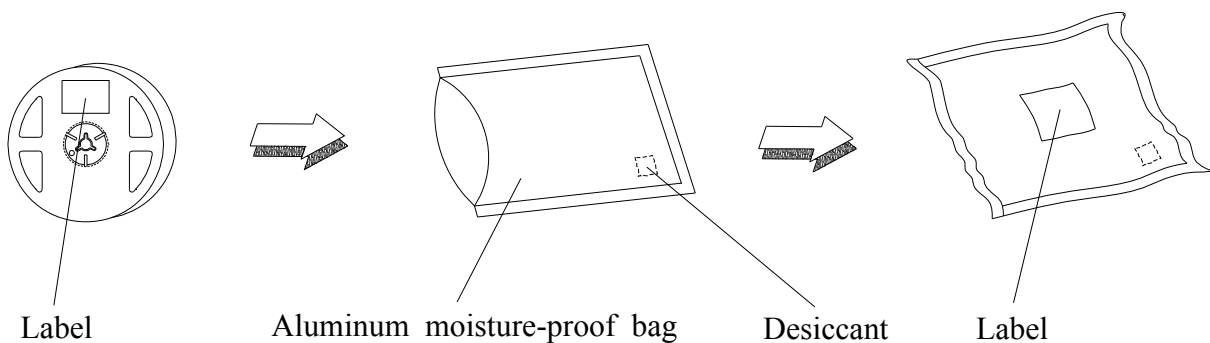

Technical Data Sheet

Full Color Top View LEDs

67-03/RSGHBHC-B06/1T

Reliability Test Items and Conditions

The reliability of products shall be satisfied with items listed below.

Confidence level : 90%

LTPD : 10%

No.	Items	Test Condition	Test Hours/Cycles	Sample Size	Ac/Re
1	Reflow Soldering	Temp. : 260°C±5°C Min. 5sec.	6 Min.	22 PCS.	0/1
2	Temperature Cycle	H : +100°C 15min ┆ 5 min L : -40°C 15min	300 Cycles	22 PCS.	0/1
3	Thermal Shock	H : +100°C 5min ┆ 10 sec L : -10°C 5min	300 Cycles	22 PCS.	0/1
4	High Temperature Storage	Temp. : 100°C	1000 Hrs.	22 PCS.	0/1
5	Low Temperature Storage	Temp. : -40°C	1000 Hrs.	22 PCS.	0/1
6	DC Operating Life	I _F = 20 mA	1000 Hrs.	22 PCS.	0/1
7	High Temperature / High Humidity	85°C / 85%RH	1000 Hrs.	22 PCS.	0/1

Technical Data Sheet

Full Color Top View LEDs

67-03/RSGHBHC-B06/1T

Precautions for Use

1. Over-current-proof

Customer must apply resistors for protection; otherwise slight voltage shift will cause big current change (Burn out will happen).

2. Storage

2.1 Do not open moisture proof bag before the products are ready to use.

2.2 Before opening the package: The LEDs should be kept at 30°C or less and 90%RH or less.

2.3 After opening the package: The LED's floor life is 72 hours under 30°C or less and 60% RH or less. If unused LEDs remain, it should be stored in moisture proof packages.

2.4 If the moisture absorbent material (silica gel) has faded away or the LEDs have exceeded the storage time, baking treatment should be performed using the following conditions.

Baking treatment: 60±5°C for 24 hours.

3. Soldering Condition

3.1 Pb-free solder temperature profile

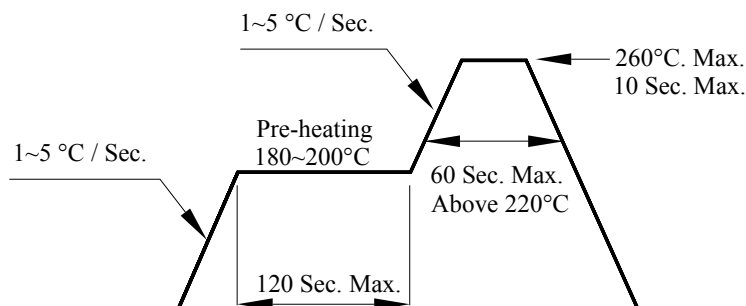

3.2 Reflow soldering should not be done more than two times.

3.3 When soldering, do not put stress on the LEDs during heating.

3.4 After soldering, do not warp the circuit board.

Technical Data Sheet

Full Color Top View LEDs

67-03/RSGHBHC-B06/1T

4. Soldering Iron

Each terminal is to go to the tip of soldering iron temperature less than 350°C for 3 seconds within once in less than the soldering iron capacity 25W. Leave two seconds and more intervals, and do soldering of each terminal. Be careful because the damage of the product is often started at the time of the hand solder.

5. Repairing

Repair should not be done after the LEDs have been soldered. When repairing is unavoidable, a double-head soldering iron should be used (as below figure). It should be confirmed beforehand whether the characteristics of the LEDs will or will not be damaged by repairing.

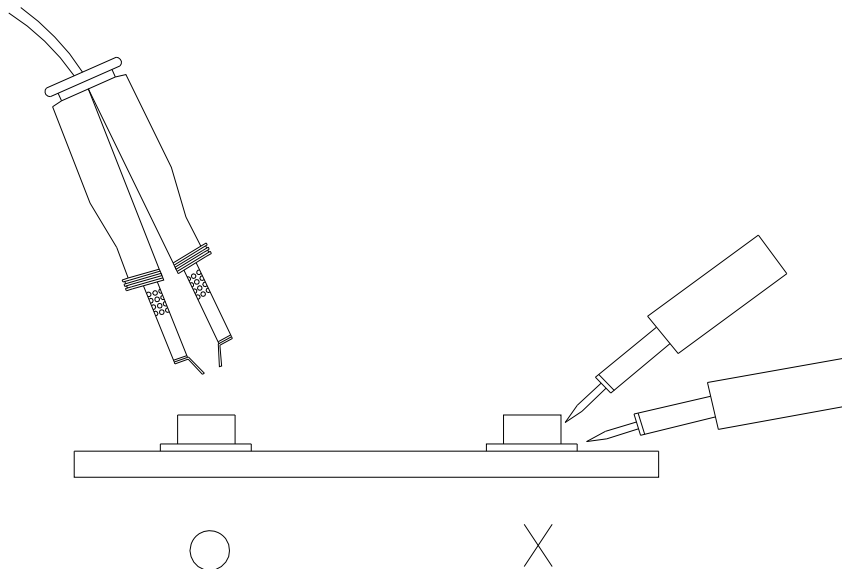

EVERLIGHT ELECTRONICS CO., LTD.
Office: No 25, Lane 76, Sec 3, Chung Yang Rd,
Tucheng, Taipei 236, Taiwan, R.O.C

Tel: 886-2-2267-2000, 2267-9936
Fax: 886-2267-6244, 2267-6189, 2267-6306
<http://www.everlight.com>