

Technical Data Sheet

Luminosity Full Color LED

61-23 /R6GHBHC-A01/ET

Features

- Super-luminosity chip LED.
- White SMT package.
- Built in Red, Green, and Blue chips.
- Lead frame package with individual 6 pins.
- Wide viewing angle.
- Soldering methods: IR reflow soldering.
- Pb-free.
- The product itself will remain within RoHS compliant version.



Descriptions

- Due to the package design, 61-23 has wide viewing angle , low power consumption and adjusting each color is possible thanks to serial connection by 6 terminal connection (Individual driving by each terminal) in case of using several number of LED. And makes it ideal for light pipe application.

Applications

- Amusement equipment.
- Information boards.
- Flashlight for digital camera of cellular phone.

Device Selection Guide

Chip		Emitted Color	Resin Color
Type	Material		
R6	AlGaInP	Brilliant Red	Water Clear
GH	InGaN	Brilliant Green	
BH	InGaN	Blue	

Technical Data Sheet

Luminosity Full Color LED

61-23 /R6GHBHC-A01/ET

Package Outline Dimensions

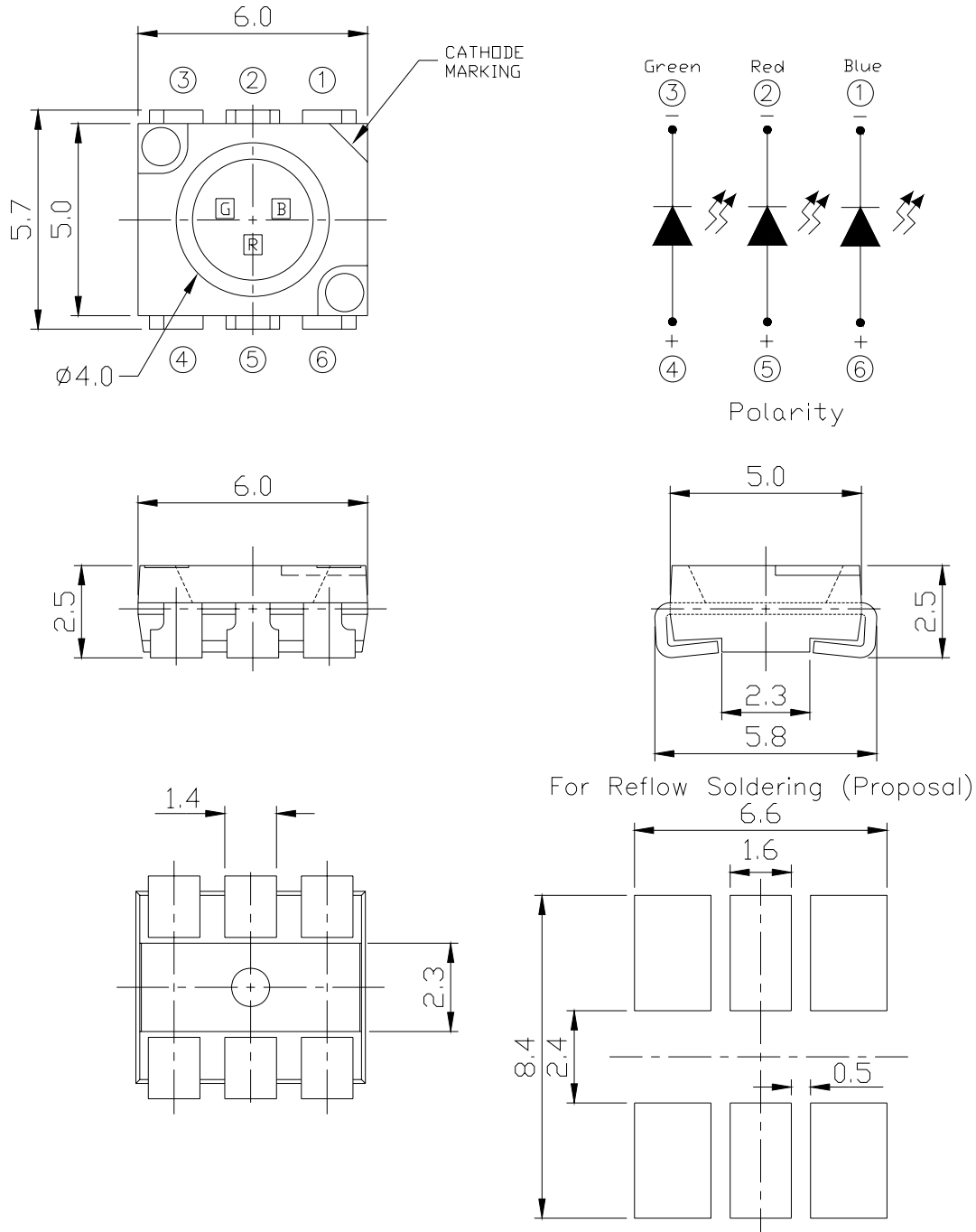

Notes: 1.All dimensions are in millimeters. 2.Tolerances unspecified are ± 0.1 mm.

**Technical Data Sheet****Luminosity Full Color LED****61-23 /R6GHBHC-A01/ET****Absolute Maximum Ratings (Ta=25°C)**

Parameter	Symbol	Rating		Unit
Reverse Voltage	V _R	5		V
Forward Current	I _F	R6	50	mA
		GH	25	
		BH	25	
Peak Forward Current (Duty 1/10 @ 1KHz)	I _{FP}	R6	100	mA
		GH	100	
		BH	100	
Power Dissipation	Pd	R6	120	mW
		GH	110	
		BH	110	
Electrostatic Discharge(HBM)	ESD	R6	2000	V
		GH	1000	
		BH	1000	
Operating Temperature	Topr	-40 ~ +85		°C
Storage Temperature	Tstg	-40~ +100		°C
Soldering Temperature	Tsol	Reflow Soldering : 260 °C for 10 sec.		
		Hand Soldering : 350 °C for 3 sec.		

**Technical Data Sheet****Luminosity Full Color LED****61-23 /R6GHBHC-A01/ET****Electro-Optical Characteristics (Ta=25°C)**

Parameter	Symbol	Min.	Typ.	Max.	Unit	Condition	
Luminous Intensity	I _v	R6	112	200	-----	mcd	I _F =20mA
		GH	225	280	-----		I _F =20mA
		BH	90	150	-----		I _F =20mA
Viewing Angle	2θ 1/2	-----	120	-----	deg	I _F =20mA	
Peak Wavelength	λ _p	R6	-----	632	-----	nm	I _F =20mA
		GH	-----	518	-----		
		BH	-----	468	-----		
Dominant Wavelength	λ _d	R6	-----	624	-----	nm	I _F =20mA
		GH	-----	525	-----		
		BH	-----	470	-----		
Spectrum Radiation Bandwidth	Δλ	R6	-----	20	-----	nm	I _F =20mA
		GH	-----	35	-----		
		BH	-----	35	-----		
Forward Voltage	V _F	R6	-----	2.0	2.4	V	I _F =20mA
		GH	-----	3.5	4.0		
		BH	-----	3.5	4.0		
Reverse Current	I _R	R6	-----	-----	10	μA	V _R =5V
		GH	-----	-----	50		
		BH	-----	-----	50		

Technical Data Sheet

Luminosity Full Color LED

61-23 /R6GHBHC-A01/ET

Typical Electro-Optical Characteristics Curves (BH)

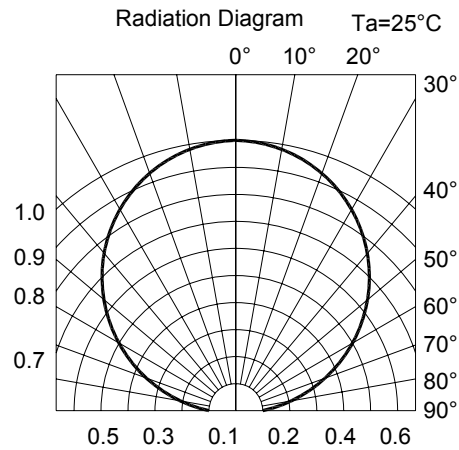
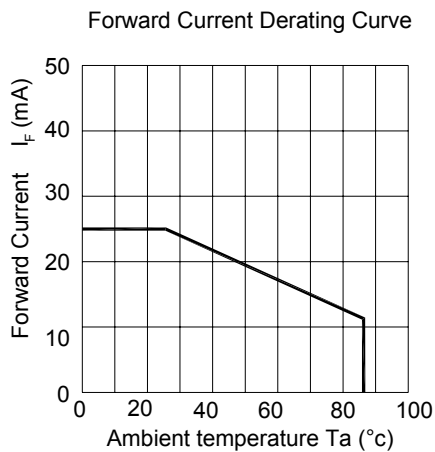
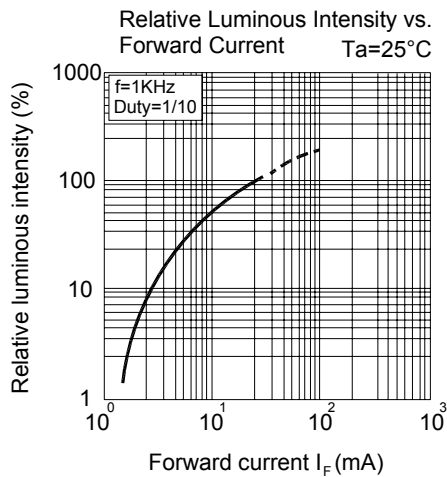
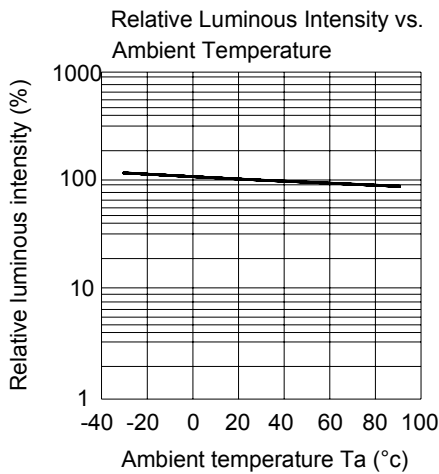
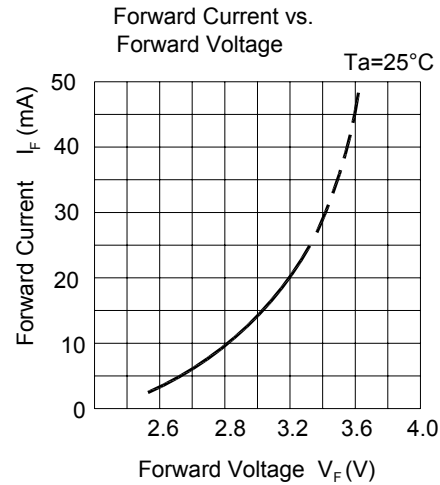
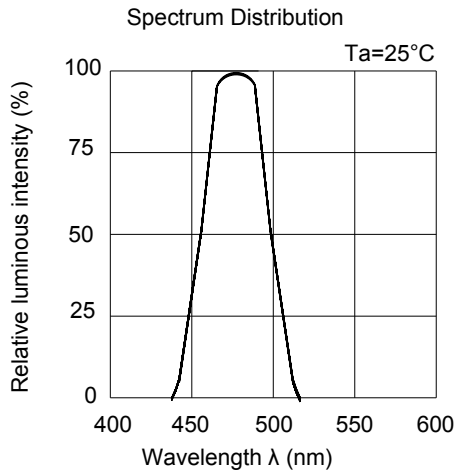

Technical Data Sheet

Luminosity Full Color LED

61-23 /R6GHBHC-A01/ET

Typical Electro-Optical Characteristics Curves (GH)

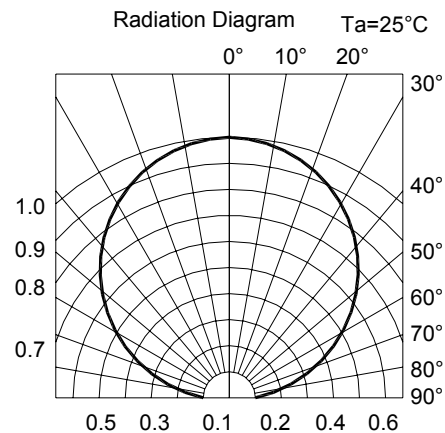
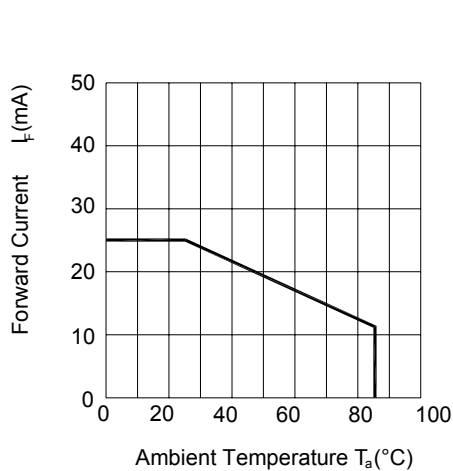
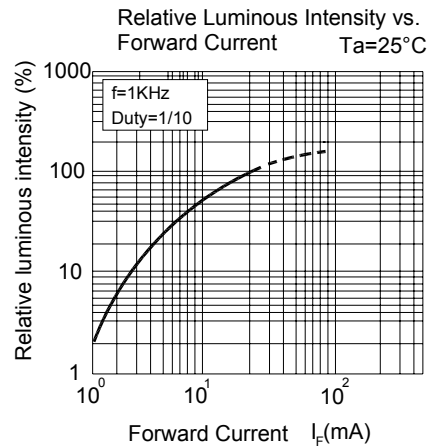
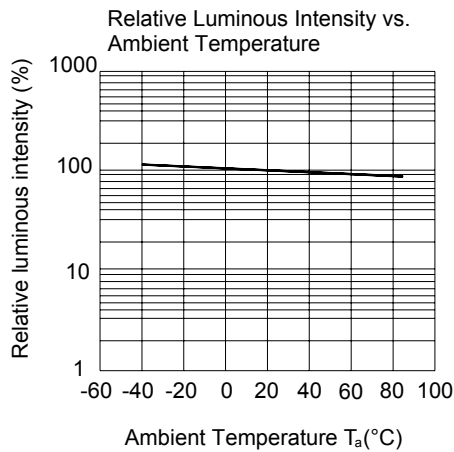
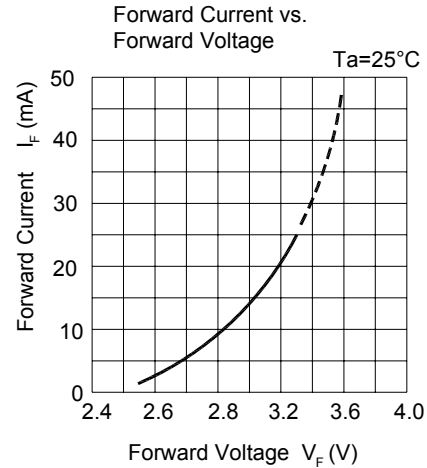
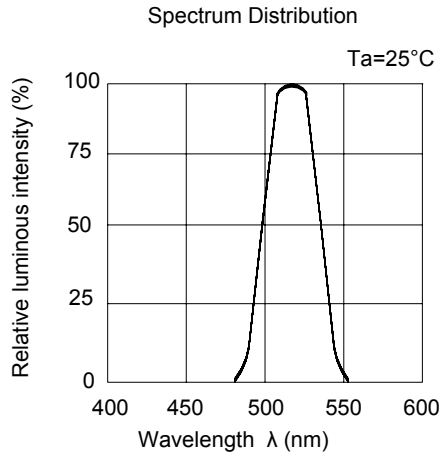



Technical Data Sheet

Luminosity Full Color LED

61-23 /R6GHBHC-A01/ET

Typical Electro-Optical Characteristics Curves (R6)

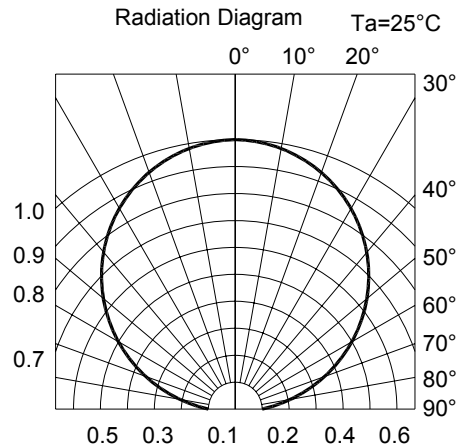
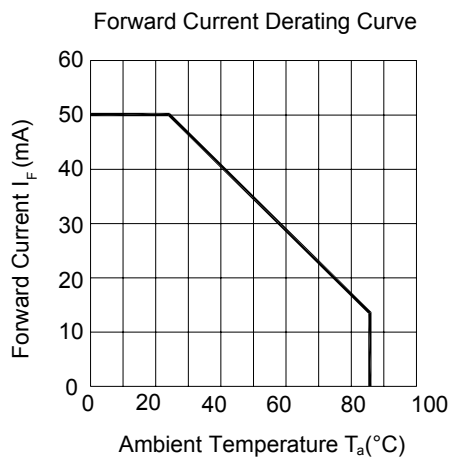
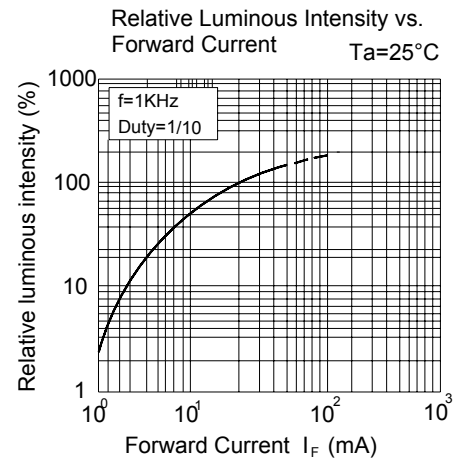
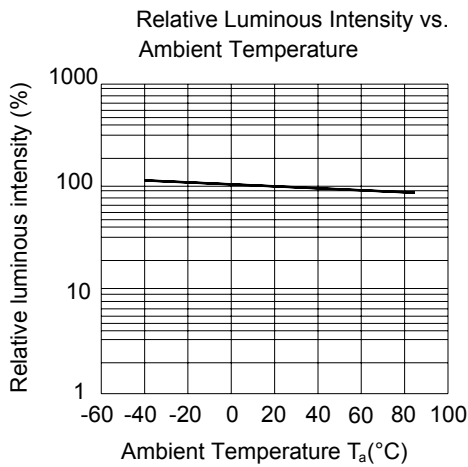
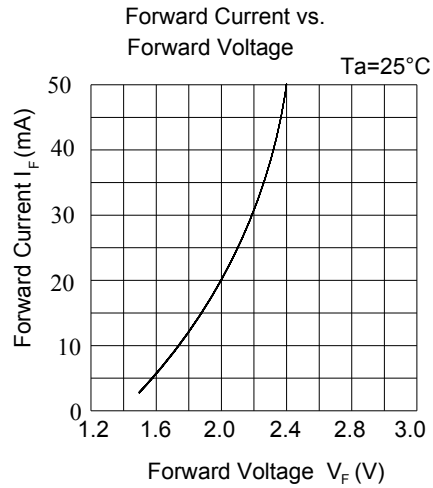
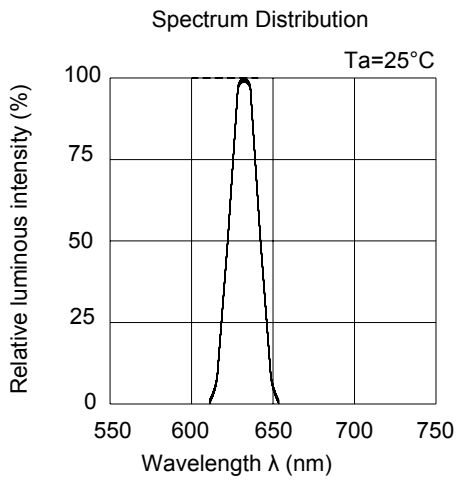



Technical Data Sheet

Luminosity Full Color LED

61-23 /R6GHBHC-A01/ET

Label Explanation

CAT: Luminous Intensity Rank

HUE: Dom. Wavelength Rank

REF: Forward Voltage Rank

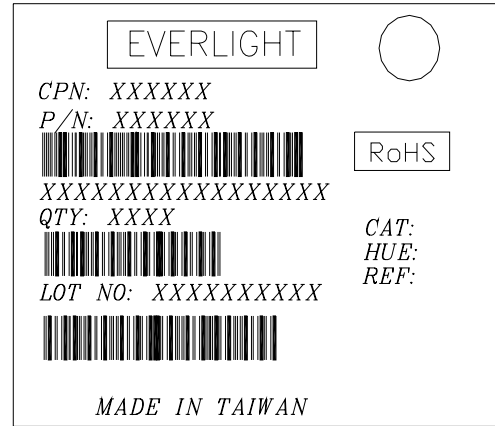

Reel Dimensions

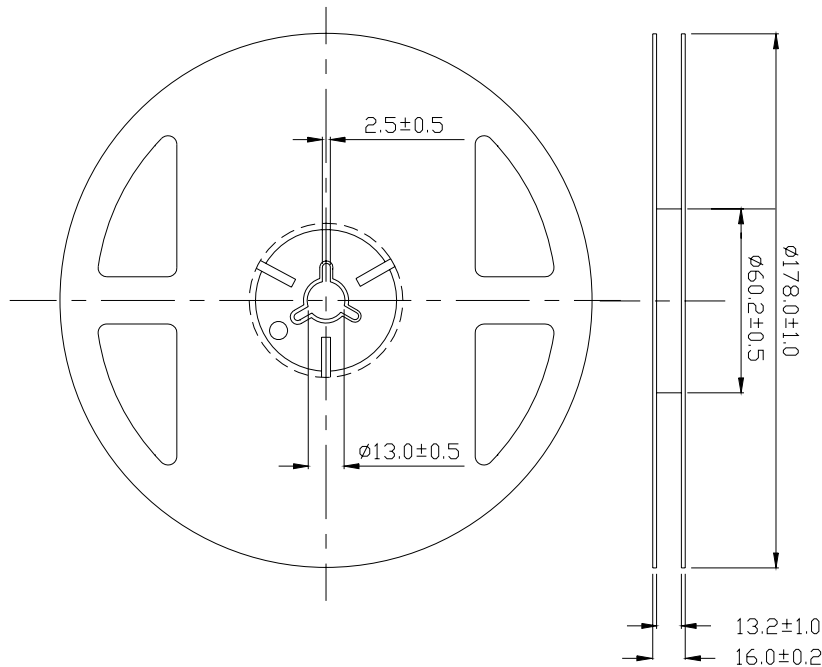

Note: Tolerance unless mentioned is ±0.1mm; Unit = mm



Technical Data Sheet

Luminosity Full Color LED

61-23 /R6GHBHC-A01/ET

Carrier Tape Dimensions: Loaded Quantity 800 pcs Per Reel

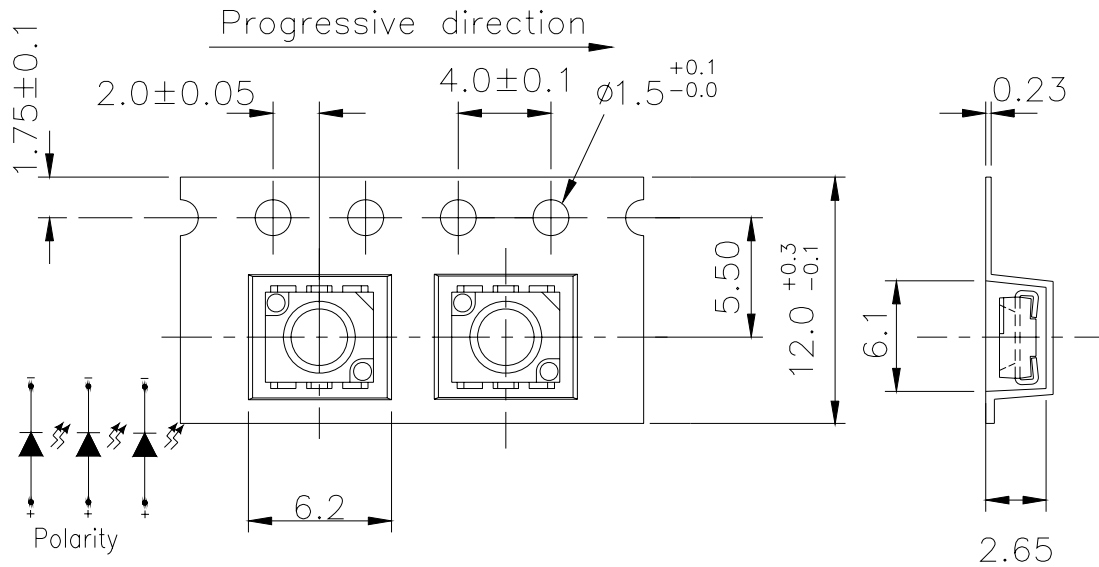

Note: Tolerance unless mentioned is ±0.1mm; Unit = mm

Moisture Resistant Packaging

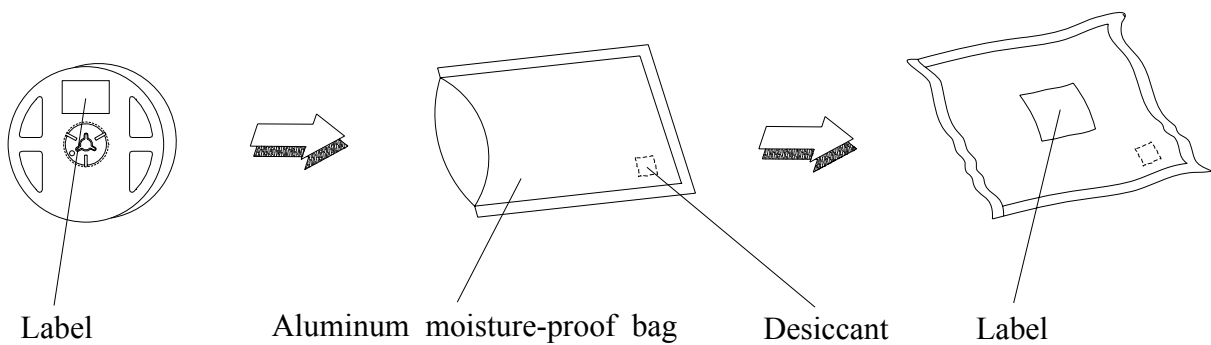

**Technical Data Sheet****Luminosity Full Color LED****61-23 /R6GHBHC-A01/ET****Reliability Test Items and Conditions**

The reliability of products shall be satisfied with items listed below.

Confidence level : 90%

LTPD : 10%

No.	Items	Test Condition	Test Hours/Cycles	Sample Size	Ac/Re
1	Reflow Soldering	Temp. : 260°C±5°C Min. 5sec.	6 min	22 PCS.	0/1
2	Temperature Cycle	H : +100°C 15min ∫ 5 min L : -40°C 15min	300 Cycles	22 PCS.	0/1
3	Thermal Shock	H : +100°C 5min ∫ 10 sec L : -10°C 5min	300 Cycles	22 PCS.	0/1
4	High Temperature Storage	Temp. : 100°C	1000 Hrs.	22 PCS.	0/1
5	Low Temperature Storage	Temp. : -40°C	1000 Hrs.	22 PCS.	0/1
6	DC Operating Life	I _F = 20 mA	1000 Hrs.	22 PCS.	0/1
7	High Temperature / High Humidity	85°C / 85%RH	1000 Hrs.	22 PCS.	0/1

Technical Data Sheet**Luminosity Full Color LED****61-23 /R6GHBHC-A01/ET****Precautions for Use**

1. Over-current-proof

Customer must apply resistors for protection; otherwise slight voltage shift will cause big current change (Burn out will happen).

2. Storage

2.1 Do not open moisture proof bag before the products are ready to use.

2.2 Before opening the package: The LEDs should be kept at 30°C or less and 90%RH or less.

2.3 After opening the package: The LED's floor life are 72 hours under 30°C or less and 60% RH or less. If unused LEDs remain, it should be stored in moisture proof packages.

2.4 If the moisture absorbent material (silica gel) has faded away or the LEDs have exceeded the storage time, baking treatment should be performed using the following conditions.

Baking treatment: 60±5°C for 24 hours.

3. Soldering Condition

3.1 Pb-free solder temperature profile

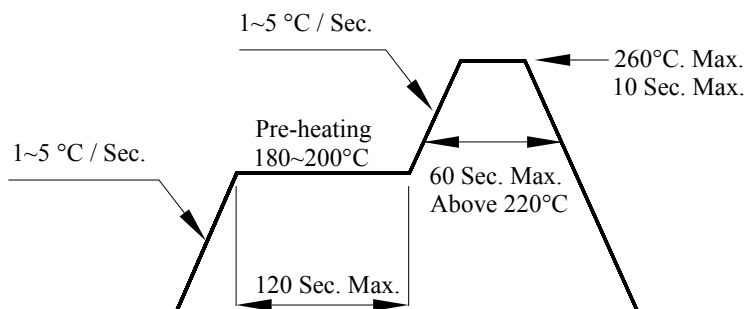

3.2 Reflow soldering should not be done more than two times.

3.3 When soldering, do not put stress on the LEDs during heating.

3.4 After soldering, do not warp the circuit board.

Technical Data Sheet**Luminosity Full Color LED****61-23 /R6GHBHC-A01/ET****4. Soldering Iron**

Each terminal is to go to the tip of soldering iron temperature less than 350°C for 3 seconds within once in less than the soldering iron capacity 25W. Leave two seconds and more intervals, and do soldering of each terminal. Be careful because the damage of the product is often started at the time of the hand solder.

5. Repairing

Repair should not be done after the LEDs have been soldered. When repairing is unavoidable, a double-head soldering iron should be used (as below figure). It should be confirmed beforehand whether the characteristics of the LEDs will or will not be damaged by repairing.

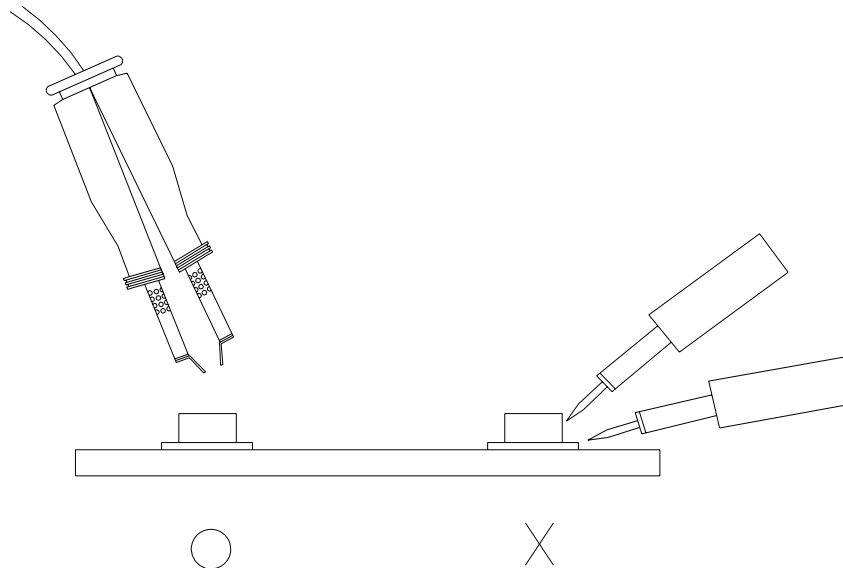
**EVERLIGHT ELECTRONICS CO., LTD.**

Office: No 25, Lane 76, Sec 3, Chung Yang Rd,
Tucheng, Taipei 236, Taiwan, R.O.C

Tel: 886-2-2267-2000, 2267-9936

Fax: 886-2267-6244, 2267-6189, 2267-6306

<http://www.everlight.com>