

Features and Benefits

- Diffused Junction
- Ultra-Fast Switching for High Efficiency
- Surge Overload Rating to 50A Peak
- Low Reverse Leakage Current
- **Lead Free Finish, RoHS Compliant (Note 1)**

Mechanical Data

- Case: DO-41, DO-15
- Case Material: Molded Plastic. UL Flammability Classification Rating 94V-0
- Moisture Sensitivity: Level 1 per J-STD-020
- Terminals: Finish — Tin. Plated Leads Solderable per MIL-STD-202, Method 208 
- Polarity: Cathode Band
- Marking: Type Number
- DO-41 Weight: 0.35 grams (approximate)
- DO-15 Weight: 0.40 grams (approximate)

Ordering Information (Note 2)

Device	Packaging	Shipping
UF1501-B	DO-15	1K/Bulk
UF1501-T	DO-15	5K/Tape & Reel, 13-inch
UF1502-B	DO-15	1K/Bulk
UF1502-T	DO-15	5K/Tape & Reel, 13-inch
UF1503-B	DO-15	1K/Bulk
UF1503-T	DO-15	5K/Tape & Reel, 13-inch
UF1504-B	DO-15	1K/Bulk
UF1504-T	DO-15	5K/Tape & Reel, 13-inch
UF1505-B	DO-15	1K/Bulk
UF1505-T	DO-15	5K/Tape & Reel, 13-inch
UF1506-B	DO-15	1K/Bulk
UF1506-T	DO-15	5K/Tape & Reel, 13-inch
UF1507-B	DO-15	1K/Bulk
UF1507-T	DO-15	5K/Tape & Reel, 13-inch
UF1501S-B	DO-41	1K/Bulk
UF1501S-T	DO-41	5K/Tape & Reel, 13-inch
UF1502S-B	DO-41	1K/Bulk
UF1502S-T	DO-41	5K/Tape & Reel, 13-inch
UF1503S-B	DO-41	1K/Bulk
UF1503S-T	DO-41	5K/Tape & Reel, 13-inch
UF1504S-B	DO-41	1K/Bulk
UF1504S-T	DO-41	5K/Tape & Reel, 13-inch
UF1505S-B	DO-41	1K/Bulk
UF1505S-T	DO-41	5K/Tape & Reel, 13-inch
UF1506S-B	DO-41	1K/Bulk
UF1506S-T	DO-41	5K/Tape & Reel, 13-inch
UF1507S-B	DO-41	1K/Bulk
UF1507S-T	DO-41	5K/Tape & Reel, 13-inch

- Notes: 1. EU Directive 2002/95/EC (RoHS). All applicable RoHS exemptions applied, see *EU Directive 2002/95/EC Annex Notes*
 2. For packaging details, visit our website at <http://www.diodes.com/datasheets/ap02007.pdf>.

Maximum Ratings @ $T_A = 25^\circ\text{C}$ unless otherwise specified

Single phase, half wave, 60Hz, resistive or inductive load.
For capacitive load, derate current by 20%.

Characteristic	Symbol	UF 1501/S	UF 1502/S	UF 1503/S	UF 1504/S	UF 1505/S	UF 1506/S	UF 1507/S	Unit
Peak Repetitive Reverse Voltage	V_{RRM}	50	100	200	400	600	800	1000	V
Working Peak Reverse Voltage	V_{RWM}								
DC Blocking Voltage (Note 3)	V_R								
RMS Reverse Voltage	$V_{R(RMS)}$	35	70	140	280	420	560	700	V
Average Rectified Output Current (Note 4) @ $T_A = 50^\circ\text{C}$	I_O	1.5							A
Non-Repetitive Peak Forward Surge Current 8.3ms Single Half Sine-Wave Superimposed on Rated Load	I_{FSM}	50							A

Thermal Characteristics

Characteristic	Symbol	Value	Unit
Typical Thermal Resistance Junction to Ambient	$R_{\theta JA}$	70	$^\circ\text{C/W}$
Operating and Storage Temperature Range	T_J, T_{STG}	-65 to +150	$^\circ\text{C}$

Electrical Characteristics @ $T_A = 25^\circ\text{C}$ unless otherwise specified

Characteristic	Symbol	UF 1501/S	UF 1502/S	UF 1503/S	UF 1504/S	UF 1505/S	UF 1506/S	UF 1507/S	Unit
Forward Voltage @ $I_F = 1.5\text{A}$	V_{FM}	1.0			1.3	1.7			V
Peak Reverse Current @ $T_A = 25^\circ\text{C}$	I_{RM}	5.0							μA
at Rated DC Blocking Voltage (Note 3) @ $T_A = 100^\circ\text{C}$		100							
Reverse Recovery Time (Note 5)	t_{rr}	50				75			ns
Typical Total Capacitance (Note 6)	C_T	35				20			pF

- Notes:
3. Short duration pulse test used to minimize self-heating effect.
 4. Valid provided that leads are maintained at ambient temperature at a distance of 9.5mm from the case.
 5. Measured with $I_F = 0.5\text{A}$, $I_R = 1.0\text{A}$, $I_{rr} = 0.25\text{A}$. See figure 5.
 6. Measured at 1.0MHz and applied reverse voltage of 4.0V DC.

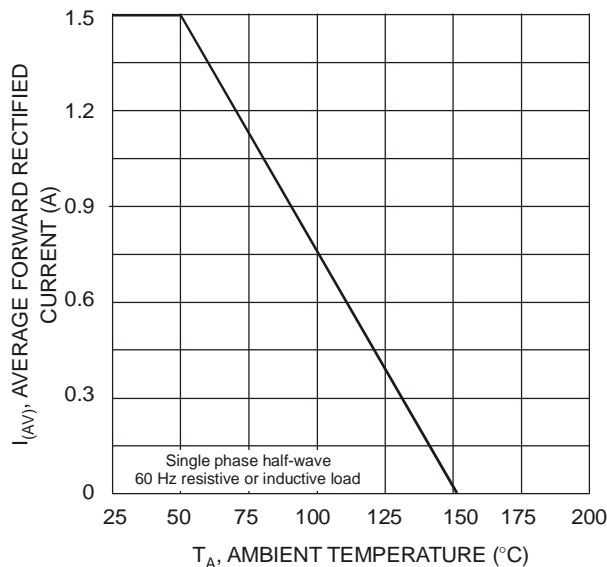

Fig. 1 Forward Current Derating Curve

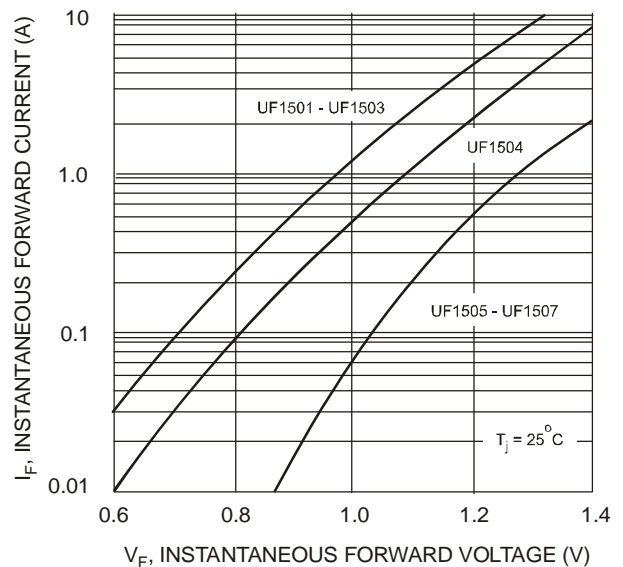
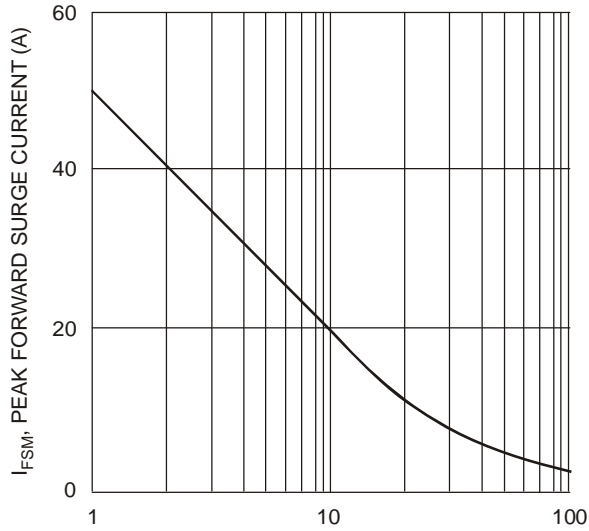
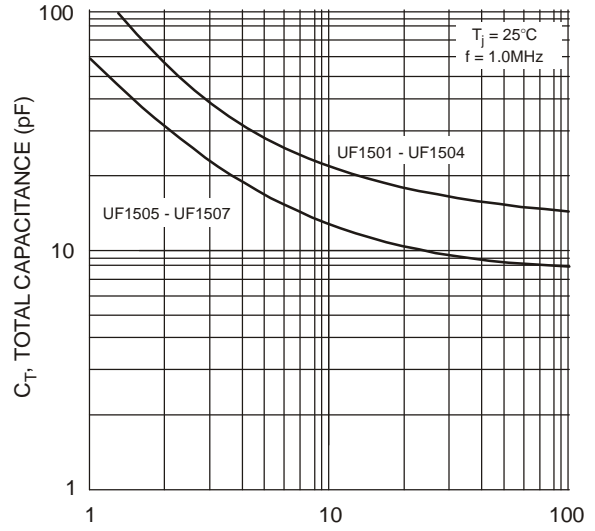

Fig. 2 Typical Forward Characteristics



NUMBER OF CYCLES AT 60Hz
Fig. 3 Peak Forward Surge Current



V_R, DC REVERSE VOLTAGE (V)
Fig. 4 Typical Total Capacitance

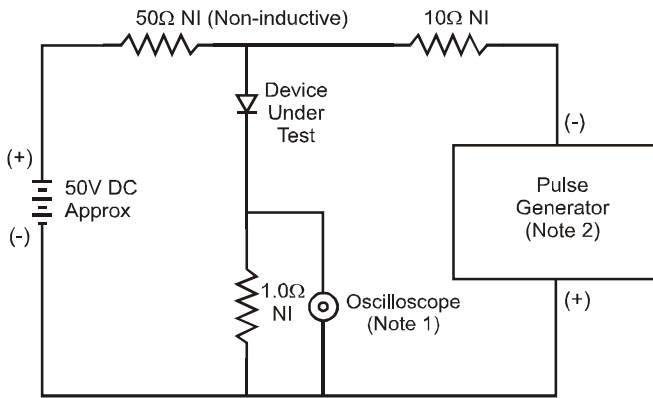

- Notes:
1. Rise Time = 7.0ns max. Input Impedance = 1.0MΩ, 22pF.
2. Rise Time = 10ns max. Input Impedance = 50Ω.

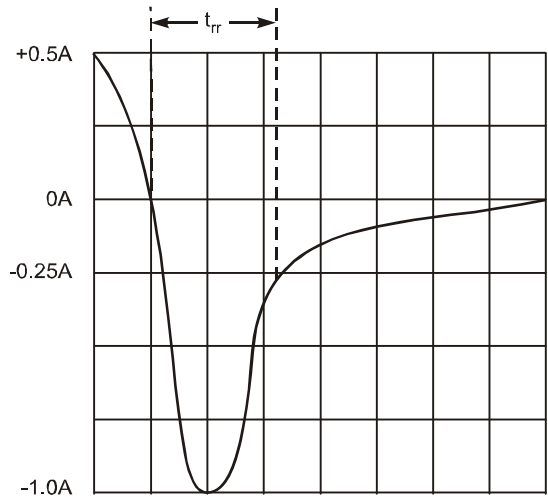

Set time base for 50/100 ns/cm

Fig. 5 Reverse Recovery Time Characteristic and Test Circuit

Package Outline Dimensions

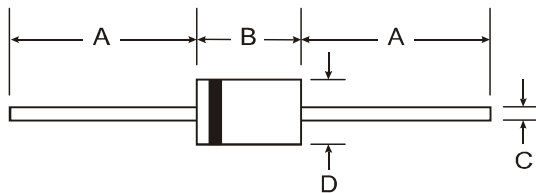

Dim	DO-41		DO-15	
	Min	Max	Min	Max
A	25.40	—	25.40	—
B	4.06	5.21	5.50	7.62
C	0.71	0.864	0.686	0.889
D	2.00	2.72	2.60	3.60
All Dimensions in mm				

"S" Suffix Designates DO-41 Package
No Suffix Designates DO-15 Package

IMPORTANT NOTICE

DIODES INCORPORATED MAKES NO WARRANTY OF ANY KIND, EXPRESS OR IMPLIED, WITH REGARDS TO THIS DOCUMENT, INCLUDING, BUT NOT LIMITED TO, THE IMPLIED WARRANTIES OF MERCHANTABILITY AND FITNESS FOR A PARTICULAR PURPOSE (AND THEIR EQUIVALENTS UNDER THE LAWS OF ANY JURISDICTION).

Diodes Incorporated and its subsidiaries reserve the right to make modifications, enhancements, improvements, corrections or other changes without further notice to this document and any product described herein. Diodes Incorporated does not assume any liability arising out of the application or use of this document or any product described herein; neither does Diodes Incorporated convey any license under its patent or trademark rights, nor the rights of others. Any Customer or user of this document or products described herein in such applications shall assume all risks of such use and will agree to hold Diodes Incorporated and all the companies whose products are represented on Diodes Incorporated website, harmless against all damages.

Diodes Incorporated does not warrant or accept any liability whatsoever in respect of any products purchased through unauthorized sales channel. Should Customers purchase or use Diodes Incorporated products for any unintended or unauthorized application, Customers shall indemnify and hold Diodes Incorporated and its representatives harmless against all claims, damages, expenses, and attorney fees arising out of, directly or indirectly, any claim of personal injury or death associated with such unintended or unauthorized application.

Products described herein may be covered by one or more United States, international or foreign patents pending. Product names and markings noted herein may also be covered by one or more United States, international or foreign trademarks.

LIFE SUPPORT

Diodes Incorporated products are specifically not authorized for use as critical components in life support devices or systems without the express written approval of the Chief Executive Officer of Diodes Incorporated. As used herein:

A. Life support devices or systems are devices or systems which:

1. are intended to implant into the body, or
2. support or sustain life and whose failure to perform when properly used in accordance with instructions for use provided in the labeling can be reasonably expected to result in significant injury to the user.

B. A critical component is any component in a life support device or system whose failure to perform can be reasonably expected to cause the failure of the life support device or to affect its safety or effectiveness.

Customers represent that they have all necessary expertise in the safety and regulatory ramifications of their life support devices or systems, and acknowledge and agree that they are solely responsible for all legal, regulatory and safety-related requirements concerning their products and any use of Diodes Incorporated products in such safety-critical, life support devices or systems, notwithstanding any devices- or systems-related information or support that may be provided by Diodes Incorporated. Further, Customers must fully indemnify Diodes Incorporated and its representatives against any damages arising out of the use of Diodes Incorporated products in such safety-critical, life support devices or systems.

Copyright © 2010, Diodes Incorporated

www.diodes.com