



	CPC1030N	Units
Load Voltage	350	V
Load Current	120	mA
Max R _{ON}	30	Ω

Features

- Small 4 Pin SOP Package
- Low Drive Power Requirements (TTL/CMOS Compatible)
- No Moving Parts
- High Reliability
- Arc-Free With No Snubbing Circuits
- 1500V_{RMS} Input/Output Isolation
- No EMI/RFI Generation
- Machine Insertable, Wave Solderable
- Tape & Reel Version Available

Applications

- Telecommunications
 - Telecom Switching
 - Tip/Ring Circuits
 - Modem Switching (Laptop, Notebook, Pocket Size)
 - Hookswitch
 - Dial Pulsing
 - Ground Start
 - Ringer Injection
- Instrumentation
 - Multiplexers
 - Data Acquisition
 - Electronic Switching
 - I/O Subsystems
 - Meters (Watt-Hour, Water, Gas)
- Medical Equipment—Patient/Equipment Isolation
- Security
- Aerospace
- Industrial Controls

Description

The CPC1030N is a miniature 1-Form-A solid state relay in a 4 pin SOP package that employs optically coupled MOSFET technology to provide 1500V of input to output isolation. The efficient MOSFET switches and photovoltaic die use Clare's patented OptoMOS[®] architecture. The optically coupled input is controlled by a highly efficient GaAlAs infrared LED. The CPC1030N uses Clare's state of the art double molded vertical construction packaging to produce the world's smallest relay. The CPC1030N offers board space savings of at least 20% over the competitor's larger 4 pin SOP relay.

Approvals

- UL Recognized Component
File#: E76270
- Certified to: EN60950

Ordering Information

Part #	Description
CPC1030N	4 Pin SOP (100/tube)
CPC1030NTR	4 Pin SOP (2,000/reel)

Pin Configuration

CPC1030N Pinout

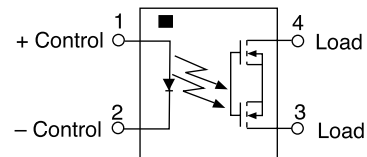

Switching Characteristics of Normally Open (Form A) Devices

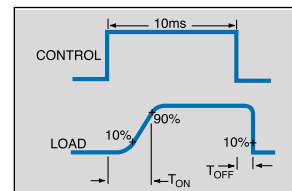

**Absolute Maximum Ratings (@ 25° C)**

Parameter	Min	Typ	Max	Units
Input Power Dissipation	-	-	150	mW
Input Control Current	-	-	50	mA
Peak (10ms)	-	-	1	A
Reverse Input Voltage	-	-	5	V
Total Power Dissipation	-	-	400 ¹	mW
Capacitance				
Input to Output	-	1	-	pF
Isolation Voltage				
Input to Output	1500	-	-	V _{RMS}
Operational Temperature	-40	-	+85	°C
Storage Temperature	-40	-	+125	°C
Soldering Temperature (10 Seconds Max.)			+220	°C

¹ Derate Linearly 3.33 mw / °C

Absolute Maximum Ratings are stress ratings. Stresses in excess of these ratings can cause permanent damage to the device. Functional operation of the device at these or any other conditions beyond those indicated in the operational sections of this data sheet is not implied. Exposure of the device to the absolute maximum ratings for an extended period may degrade the device and effect its reliability.

Electrical Characteristics

Parameter	Conditions	Symbol	Min	Typ	Max	Units
Output Characteristics @ 25°C						
Load Voltage (Peak)	-	V _L	-	-	350	V
Load Current (Continuous)						
AC Peak ¹	-	I _L	-	-	120	mA
Peak Load Current	10ms	I _{LPK}	-	-	350	mA
On-Resistance ²	I _L =120mA	R _{ON}	-	25	30	Ω
Off-State Leakage Current	V _L =350V	I _{LEAK}	-	-	1	μA
Switching Speeds						
Turn-On	I _F =5mA, V _L =10V	T _{ON}	-	-	2	ms
Turn-Off	I _F =5mA, V _L =10V	T _{OFF}	-	-	1.0	ms
Output Capacitance	50V; f=1MHz	C _{OUT}	-	25	-	pF
Input Characteristics @ 25°C						
Input Control Current ³	I _L =120mA	I _F	2	-	50	mA
Input Dropout Current	-	I _F	0.3	0.9	-	mA
Input Voltage Drop	I _F =5mA	V _F	0.9	1.2	1.4	V
Reverse Input Voltage	-	V _R	-	-	5	V
Reverse Input Current	V _R =5V	I _R	-	-	10	μA

¹ Load current derates linearly from 120mA @ 25°C to 80mA @ 85°C.

² Measurement taken within 1 second of on time.

³ For applications requiring high temperature operation (greater than 60°C) an LED drive current of 10mA is recommended.

PERFORMANCE DATA*

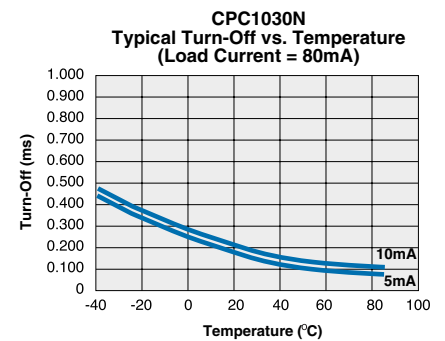
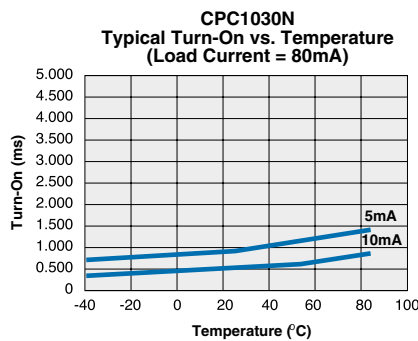
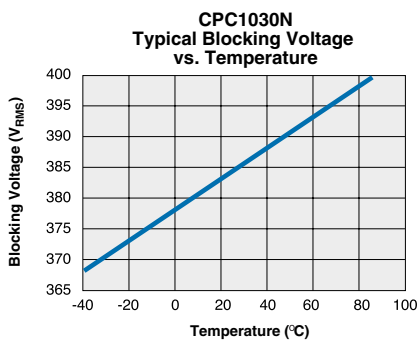
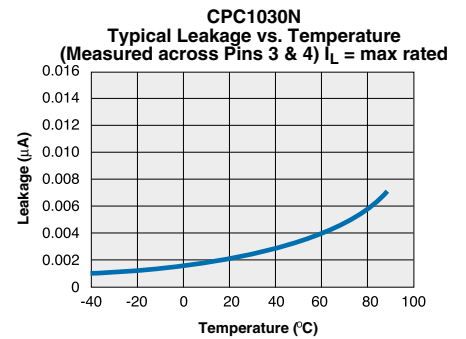
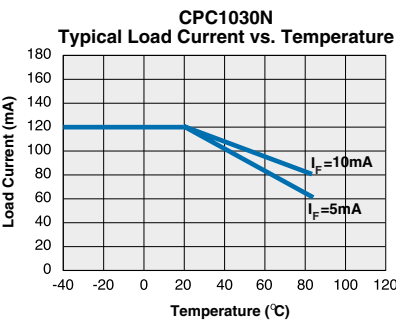
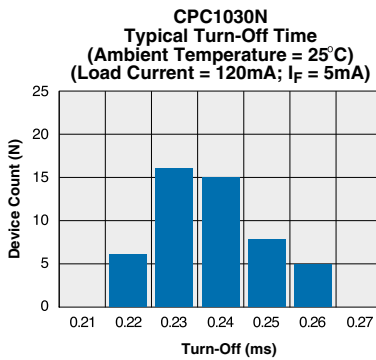
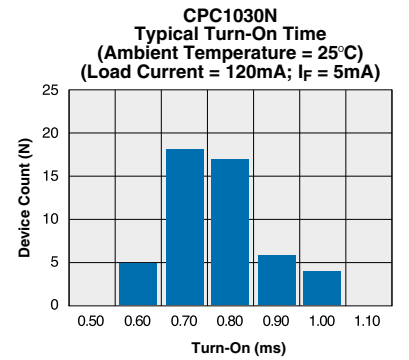
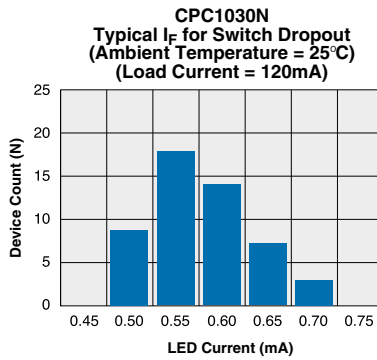
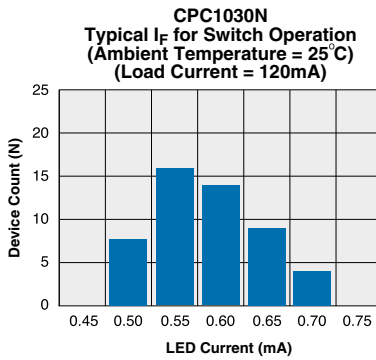
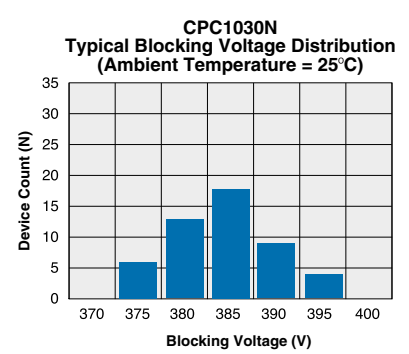
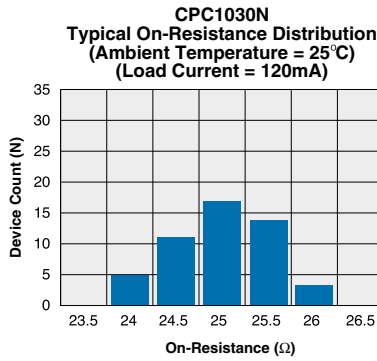
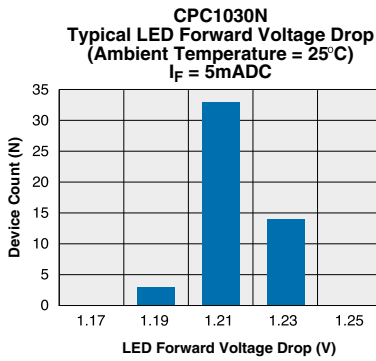

*The Performance data shown in the graphs above is typical of device performance. For guaranteed parameters not indicated in the written specifications, please contact our application department.

PERFORMANCE DATA*

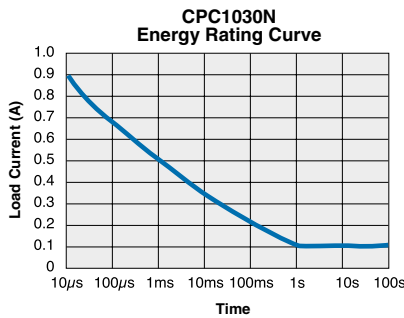
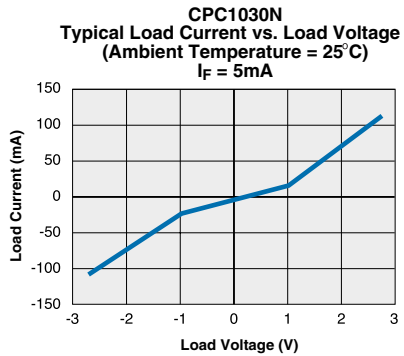
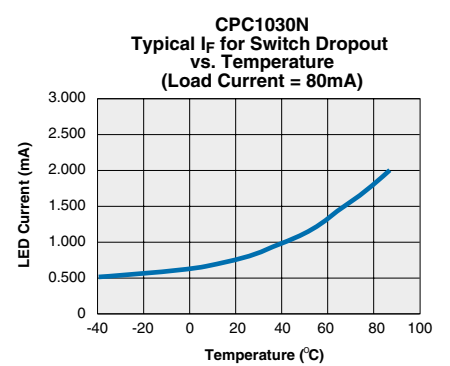
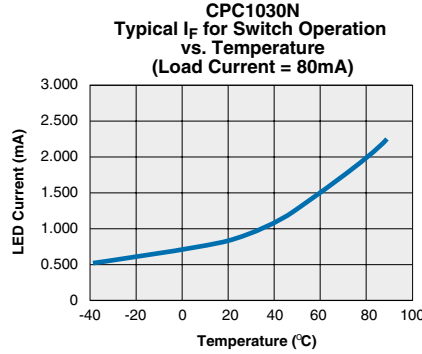
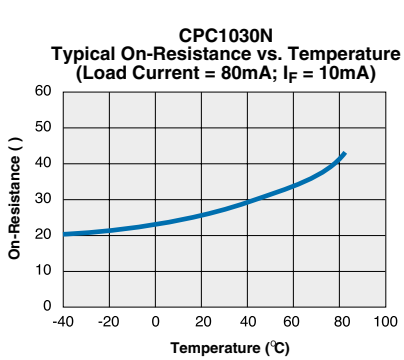
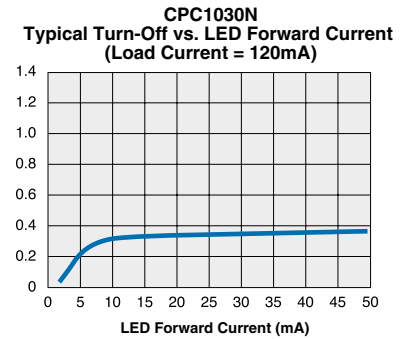
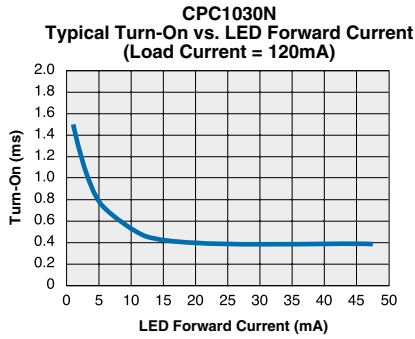
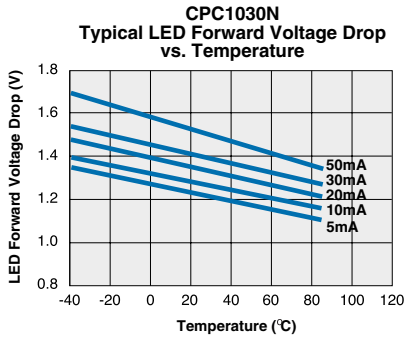

*The Performance data shown in the graphs above is typical of device performance. For guaranteed parameters not indicated in the written specifications, please contact our application department.

MECHANICAL DIMENSIONS

4 Pin SOIC Narrow ("N" Suffix)

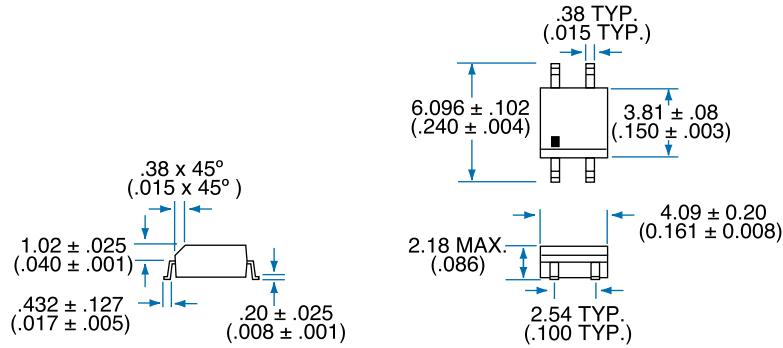

PC Board Pattern (Top View)

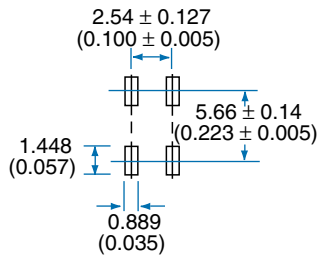

Tape and Reel Packaging for 4 pin SOIC package

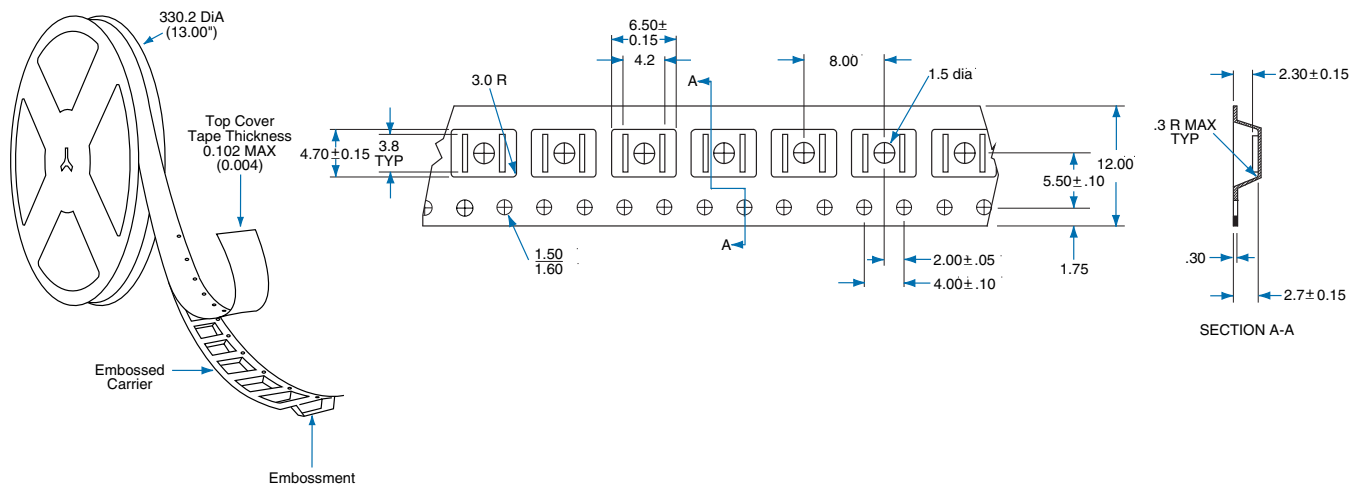

Dimensions
 mm
 (inches)



CLARE

For additional information please visit our website at: www.clare.com

Clare, Inc. makes no representations or warranties with respect to the accuracy or completeness of the contents of this publication and reserves the right to make changes to specifications and product descriptions at any time without notice. Neither circuit patent licenses nor indemnity are expressed or implied. Except as set forth in Clare's Standard Terms and Conditions of Sale, Clare, Inc. assumes no liability whatsoever, and disclaims any express or implied warranty, relating to its products including, but not limited to, the implied warranty of merchantability, fitness for a particular purpose, or infringement of any intellectual property right.

The products described in this document are not designed, intended, authorized or warranted for use as components in systems intended for surgical implant into the body, or in other applications intended to support or sustain life, or where malfunction of Clare's product may result in direct physical harm, injury, or death to a person or severe property or environmental damage. Clare, Inc. reserves the right to discontinue or make changes to its products at any time without notice.

Specification: DS-CPC1030-R5.0
©Copyright 2001, Clare, Inc.
OptoMOS[®] is a registered trademark of Clare, Inc.
All rights reserved. Printed in USA.
1/9/02