

Product Brief EVK-FUJI

Version: 1.1

High Temperature, Triple Output, 3.5W DCM Flyback DC-DC Converter

General description

The EVK-FUJI is a reference design for a non-isolated DCM Flyback DC-DC converter, with triple outputs. It is therefore a Point-of-Load solution suitable to generate 3 standard voltages from a single power supply input ranging from +12V to +28V.

The default output voltage values are +5V; +3.3V and +1.8V; they can be modified to accommodate for different voltage needs.

The EVK-FUJI is offered in the form of an Evaluation Kit including a complete Application Note, electrical schematic and bill of materials. It allows immediate evaluation and integration into an electronic design with high temperature requirements or into an MCM hybrid project.

Applications

- Embedded power supply blocks in down-hole tools
- PoL in aeronautics and aerospace
- High reliability DC-DC modules

Features

- Non-isolated topology (Flyback)
- Based on:
 - ✓ 1x PWM Controller CHT-MAGMA
 - ✓ 4x transistors CHT-NMOS8001
- Up to 68% efficiency
- Switching frequency: 100kHz
- Vin range: +12V to +28V
- Power range: 3.5W
- Triple output (customizable):
 - ✓ +5V / 400mA
 - ✓ +3.3V / 250mA
 - ✓ +1.8V / 250mA
- Regulation loop set on the +5V output
- Optional linear regulators on +3.3V/+1.8V outputs for enhanced load regulation performance:
 - ✓ 2 x CHT-VEGA suitable to supply $\pm 5\%$ voltages (adjustable within the range +4.5V~+1.2V)
- Eval board qualified from -55 to +175°C (ambient)
 - ✓ Short excursions to 200°C allowed
- Active components and transformer all qualified from -55 to +225°C (junction)
- 300°C (Tg) polyimide PCB
- PCB dimensions: 1" x 3"

Simplified Block Diagrams

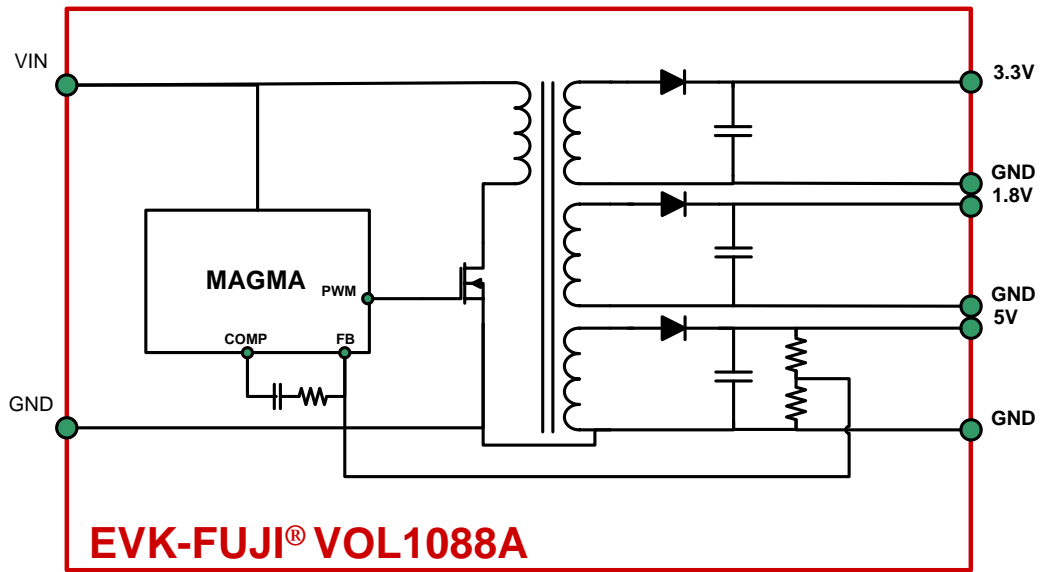


Figure 1: Triple output DCM Flyback 3.5W DC-DC Converter (EVK-VOL1088A)

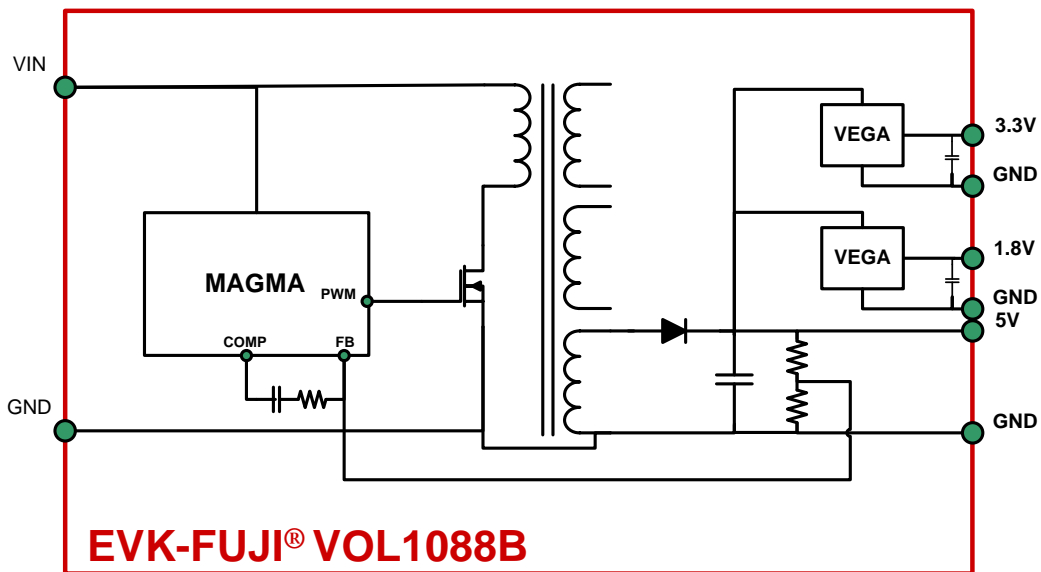
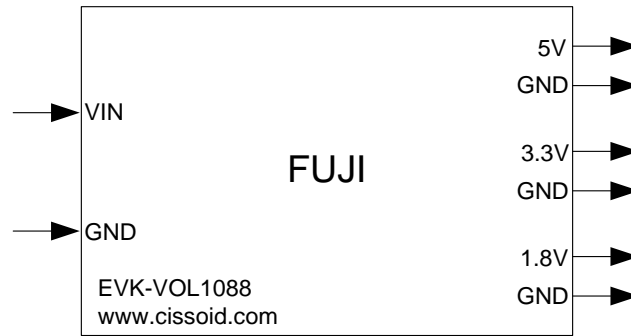


Figure 2: Triple output DCM Flyback 3.5W DC-DC Converter with regulated 3.3V / 1.8V outputs (EVK-VOL1088B)

I/Os Description

VIN	Input positive power supply
GND	Primary Ground
5V	+5V Output
3.3V	+3.3V Output
1.8V	+1.8V Output
GND	Secondary ground



Board Mechanical Drawing

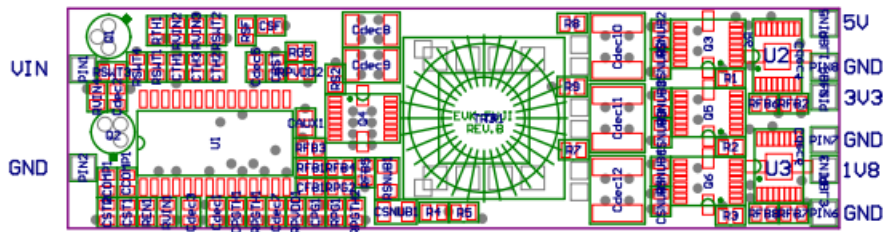


Figure 3: PCB layout (L=3''x L=1'')

General Description

EVK-FUJI implements a non-isolated fly-back converter designed to work in Discontinuous Conduction Mode. The regulation loop is a voltage control loop:

- CHT-MAGMA component implements the control loop and generates a local 5V (via its internal voltage regulator) used to drive its internal logic and the external switching transistor
- CHT-NMOS8001 MOSFET implements the switching transistor. Its offers the best compromise between size, resistive and switching losses;
- 3 additional CHT-NMOS8001 MOSFETs are used as diode to perform the rectification at the secondary;
- Optionally, 2 CHT-VEGA can be implemented on the 5V output bus to generate the 3.3V and 1.8V with enhanced regulation performance.

2 versions of the EVK-FUJI are available:

- EVK-VOL1088A: in this version, there is no regulator on the +3.3V and +1.8V outputs; this version should be used when the load variation on the different outputs is not greater than $\pm 50\%$ of the nominal value;
- EVK-VOL1088B: in this version, regulators are used to generate the +3.3V and +1.8V outputs; this version should be used if load variation on the different outputs are subject to vary significantly, beyond $\pm 50\%$ of the nominal load value, or possibly reaching zero load situations.

EVK-FUJI is a flexible and versatile platform that can be used for a number of DC-DC Converter configurations beyond the default configuration. In particular, additional customization of FUJI design can be considered to accommodate for the following needs (contact CISSODI for such requirements):

- Possibility to use an alternate voltage output (default +5V) for the flyback control regulation loop;
- Possibility to implement an isolated version (instead of the Non-isolated default topology);
- Possibility to implement a Continuous Conduction Mode (instead of the Discontinuous Conduction default mode);
- Possibility to implement a Current Mode control loop (instead of the Voltage Mode default control loop);
- Possibility to implement a Short-circuit protection (none by default).

Document References

CHT-NMOS8001: High-Temperature, 80V / 1A N-Channel MOSFET

Datasheet: <http://www.cisoid.com/images/stories/pdf/Datasheets/CHT-NMOS8001.pdf>

CHT-MAGMA: PWM Controller

Datasheet: <http://www.cisoid.com/images/stories/pdf/Datasheets/cht-magma.pdf>

CHT-VEGA: High Temperature, 500mA, Adjustable Voltage Regulator

Datasheet: <http://www.cisoid.com/images/stories/pdf/Datasheets/cht-vega.pdf>

Absolute Maximum Ratings

Stressing the EVK above these absolute maximum ratings could present permanent damage. Exposure to this maximum rating for extended periods may affect the EVK reliability. These ratings are considered individually (not in combination). If not specified, voltages are related to GND

Parameter	Min.	Max.	Units
(VIN-GND)	-0.5	30	V
Steady operating temperature	-55	175	°C
Peak operating temperature (max 1 hour)	-55	200	°C

Electrical Characteristics EVK-VOL1088A

Unless otherwise stated: $T_a=25^\circ\text{C}$, $V_{in}=20\text{V}$, $I_{out5V}=200\text{ mA}$, $I_{out3.3V}=125\text{ mA}$, $I_{out1.8V}=125\text{ mA}$

Bold underlined values indicate values valid over the whole temperature range ($-55^\circ\text{C} < T_a < +225^\circ\text{C}$).

Parameter	Condition	Min	Typ	Max	Units
Supply voltage V_{IN}		<u>12</u>		<u>28</u>	V
Output Power P_{out}				<u>3.5</u>	W
5V Output voltage initial accuracy ¹ V_{out5V}	$V_{in}=20\text{V}; T_a=25^\circ\text{C}$		± 2		%
3.3V Output voltage initial accuracy ² $V_{out3.3V}$			± 2		%
1.8V Output voltage initial accuracy ³ $V_{out1.8V}$			± 2		%
Output voltage temperature drift dV_{out}/dT	T_a between -55°C and 225°C		100		ppm/ $^\circ\text{C}$
5V Output voltage DC line regulation dV_{out}/dV_{IN}	From 12V up to 28V $T_a=25^\circ\text{C}$		-112		ppm/V
	From 12V up to 28V $T_a=225^\circ\text{C}$		-147		ppm/V
3.3V Output voltage DC line regulation dV_{out}/dV_{IN}	From 12V up to 28V $T_a=25^\circ\text{C}$		243		ppm/V
	From 12V up to 28V $T_a=225^\circ\text{C}$		187		ppm/V
1.8V Output voltage DC line regulation dV_{out}/dV_{IN}	From 12V up to 28V $T_a=25^\circ\text{C}$		210		ppm/V
	From 12V up to 28V $T_a=225^\circ\text{C}$		104		ppm/V
5V Output voltage DC load regulation dV_{out}/dI_{out}	I_{out5V} from 200 mA to 400 mA $T_a=25^\circ\text{C}$		-0.65		%
	I_{out5V} from 200 mA to 400 mA $T_a=225^\circ\text{C}$		-0.6		%
3.3V Output voltage DC load regulation dV_{out}/dI_{out}	$I_{out3.3V}$ from xx mA to xx mA $T_a=25^\circ\text{C}$		-6.8		%
	$I_{out3.3V}$ from xx mA to xx mA $T_a=225^\circ\text{C}$		-8.1		%
1.8V Output voltage DC load regulation dV_{out}/dI_{out}	$I_{out1.8V}$ from xx mA to xx mA $T_a=25^\circ\text{C}$		-6.4		%
	$I_{out1.8V}$ from xx mA to xx mA $T_a=225^\circ\text{C}$		-7.6		%
5V Output ripple	$T_a=25^\circ\text{C}$		97		mV _{pk}
	$T_a=175^\circ\text{C}$		117		mV _{pk}
3.3V Output ripple	$T_a=25^\circ\text{C}$		84		mV _{pk}
	$T_a=175^\circ\text{C}$		98		mV _{pk}
1.8V Output ripple	$T_a=25^\circ\text{C}$		89		mV _{pk}
	$T_a=175^\circ\text{C}$		102		mV _{pk}
Power Efficiency	$P_{out}=2\text{W}; T_a=175^\circ\text{C}$		66.5%		%

1 Requires initial trimming

2 Requires initial trimming

3 Requires initial trimming

Electrical Characteristics EVK-VOL1088A (cnt'd)

Unless otherwise stated: $T_a=25^\circ\text{C}$, $V_{in}=20\text{V}$, $I_{out5V} = 200\text{ mA}$, $I_{out3.3V} = 125\text{ mA}$, $I_{out1.8V} = 125\text{ mA}$

Bold underlined values indicate values valid over the whole temperature range ($-55^\circ\text{C} < T_a < +175^\circ\text{C}$).

Parameter	Condition	Min	Typ	Max	Units
Switching frequency	Central value		100		kHz
Switching frequency drift over temperature			0.2		kHz/ $^\circ\text{C}$
Line Under Voltage Lockout (UVLO) start threshold			10		V
Line Under Voltage Lockout (UVLO) stop threshold			9.4		V
Transient load response overshoot	$V_{in}=20\text{V}; T_a=25^\circ\text{C}$; I_{out} 5V from 200mA to 400mA load step (10 mA/ μs) (I_{out} 3.3V = I_{out} 1.8V = 125mA)		600		mV pk
	$V_{in}=20\text{V}; T_a=25^\circ\text{C}$; I_{out} 5V from 400mA to 200mA load step (10 mA/ μs) (I_{out} 3.3V = I_{out} 1.8V = 125mA)		500		mV pk
Start-up time			17		ms
Input current	When $V_{in} < \text{UVLO}$ - $T_a = 25^\circ\text{C}$ - $T_a = 225^\circ\text{C}$		1.3		mA
			1.6		
Input current	When no load, excluding internal bleeders, $V_{in} = [12..28]$ - $T = 25^\circ\text{C}$ - $T_a = 225^\circ\text{C}$		1.3		mA
			1.6		

Typical Performance Characteristics EVK-VOL1088A

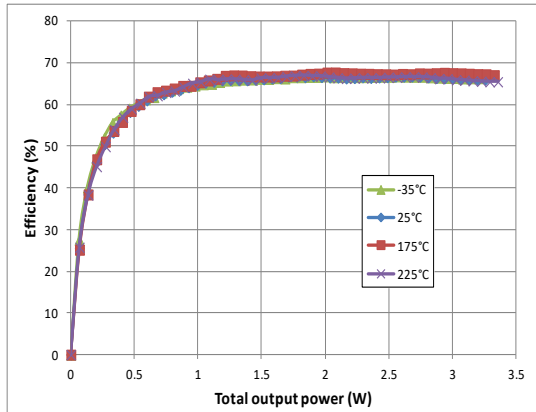


Figure 4: Efficiency vs. Pout (Vin = 20V)

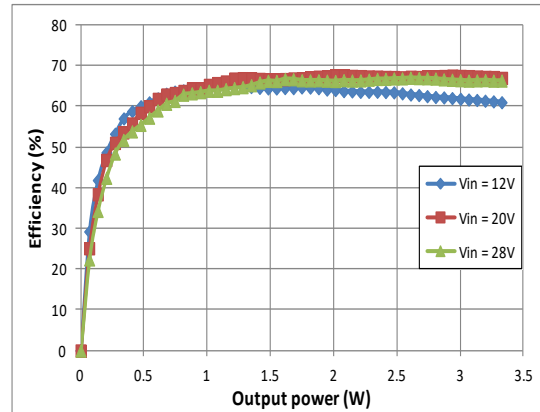


Figure 5: Efficiency vs. Vin ($T_a=175^\circ\text{C}$)

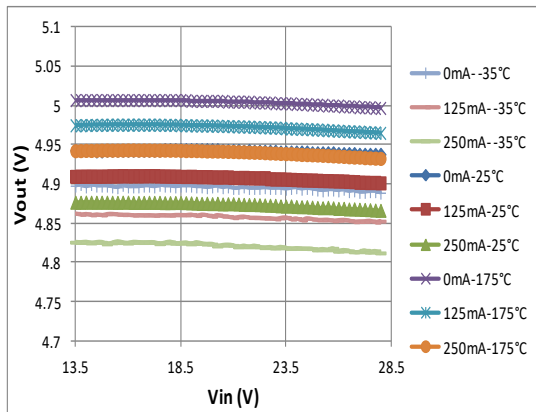


Figure 6: Line regulation on 5V output

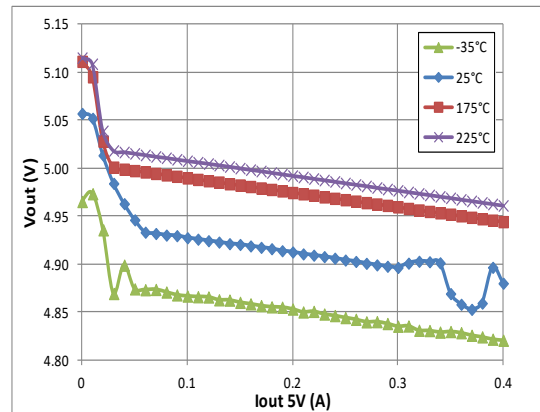


Figure 7: Load regulation Vout 5V
(Iout 3.3V = 25 mA, Iout 3.3V = 25 mA, Vin = 20V)

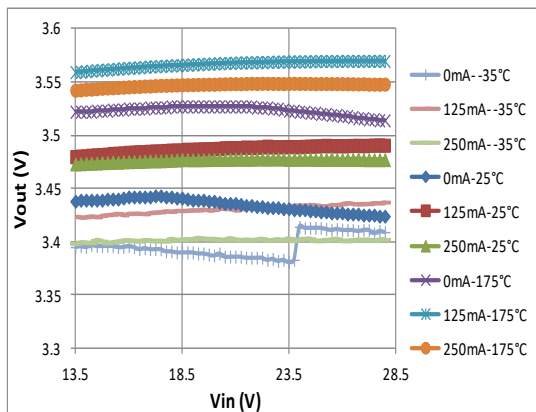


Figure 8: Line regulation on 3.3V output

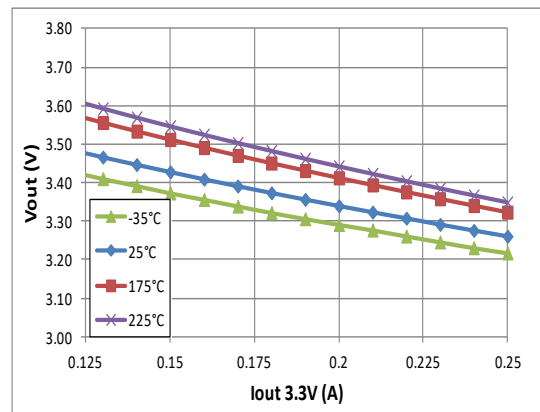


Figure 9: Load regulation Vout 3.3V
(Iout 5V = 40 mA, Iout 1.8V = 25 mA, Vin = 20V)

Typical Performance Characteristics EVK-VOL1088A (cnt'd)

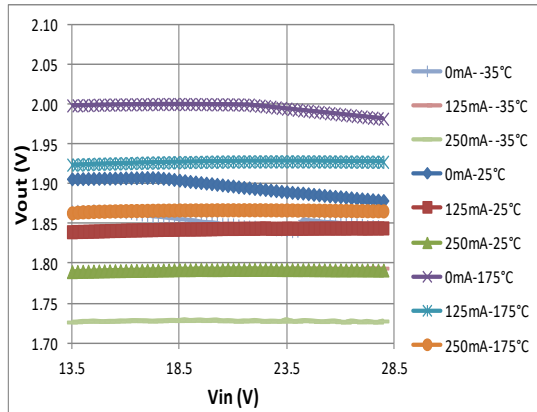


Figure 10: Line regulation on 1.8V output

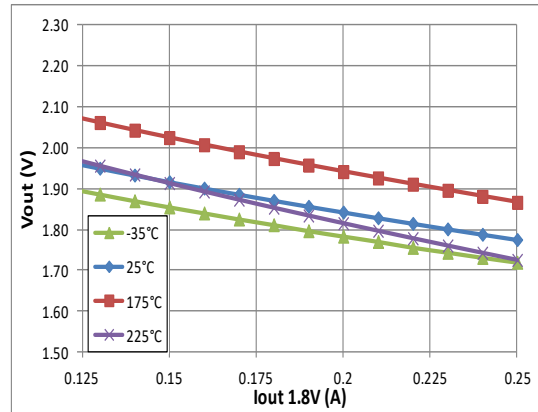


Figure 11: Load regulation Vout 1.8V
(Iout 5V = 40 mA, Iout 3.3V = 25 mA, Vin = 20V)

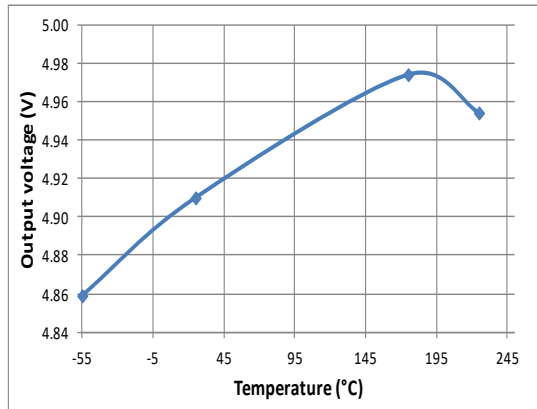


Figure 12: Output voltage (5V) drift in function of temperature (Vin = 20V, Iout5V = 200 mA, Iout3.3V = 125 mA, Iout 1.8V = 125 mA).

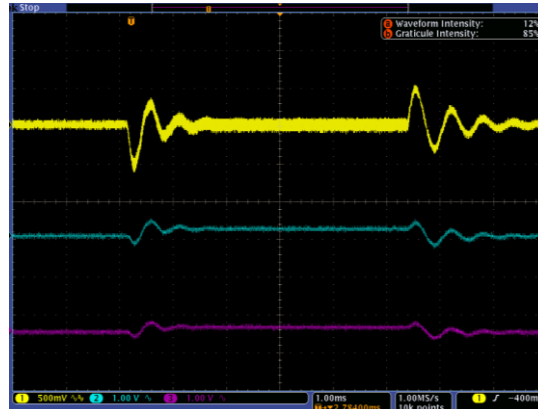


Figure 13: Fast load transient response (Vin=20V; Iout_5V switching between 200mA & 400mA, Iout_3.3V = 125mA, Iout_1.8V = 125mA with 10mA/μs slope; Ta=25°C)

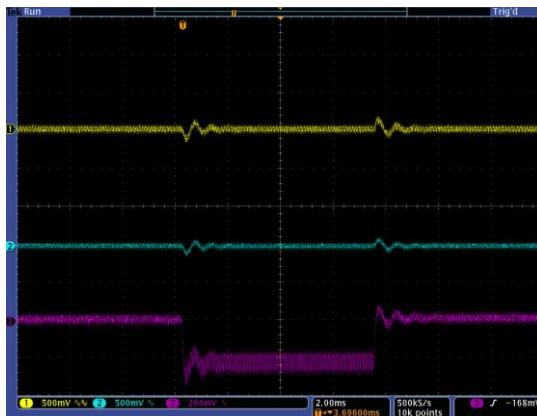


Figure 14: Fast load transient response (Vin=20V; Iout_1.8V switching between 125mA & 250mA, Iout_5V = 200mA, Iout_3.3V = 125mA with 10mA/μs slope; Ta=25°C)

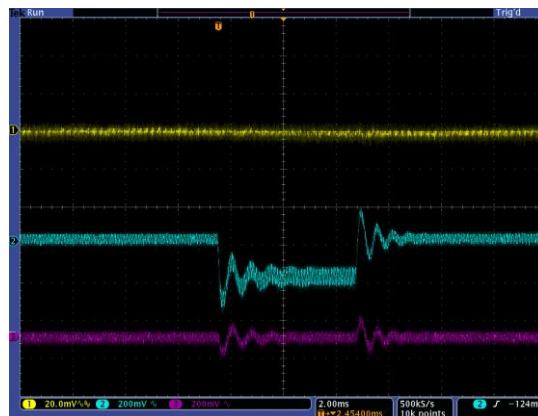


Figure 15: Fast load transient response (Vin=20V; Iout_3.3V switching between 125mA & 250mA, Iout_5V = 200mA, Iout_1.8V = 125mA with 10mA/μs slope; Ta=25°C)

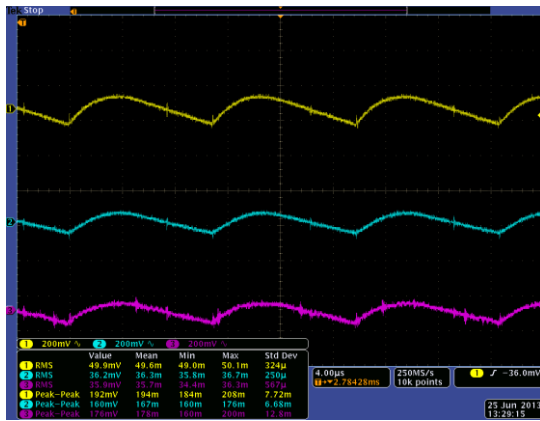
Typical Performance Characteristics EVK-VOL1088A (cnt'd)


Figure 16: AC output ripple ($V_{in}=20V, T = 25^{\circ}C, P_{out} = 2W$; 1: 5V, 2: 3.3V, 3: 1.8V)

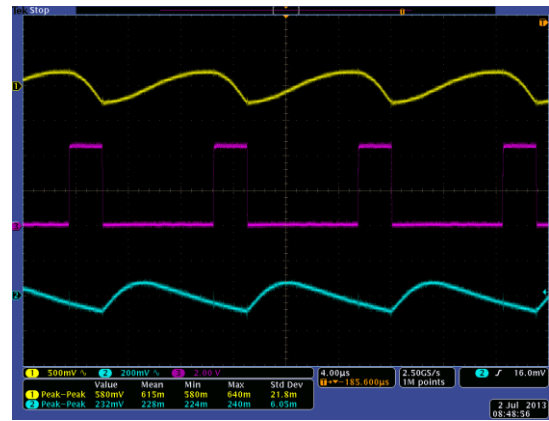


Figure 17: Input ripple ($V_{in}=20V, T = 25^{\circ}C, P_{out} = 2W$) (1 : V_{in} , 2 : V_{out} 5V, 3 : PWM)

Contact

CISSOID S.A.

Headquarters and contact EMEA:	CISSOID S.A. – Rue Francqui, 3 – 1435 Mont Saint Guibert - Belgium T : +32 10 48 92 10 - F: +32 10 88 98 75 Email: sales@cissoid.com
Sales Representatives:	Visit our website: http://www.cissoid.com

Disclaimer

Neither CISSOID, nor any of its directors, employees or affiliates make any representations or extend any warranties of any kind, either express or implied, including but not limited to warranties of merchantability, fitness for a particular purpose, and the absence of latent or other defects, whether or not discoverable. In no event shall CISSOID, its directors, employees and affiliates be liable for direct, indirect, special, incidental or consequential damages of any kind arising out of the use of its circuits and their documentation, even if they have been advised of the possibility of such a damage. The circuits are provided "as is". CISSOID has no obligation to provide maintenance, support, updates, or modifications.