

SILICON RFIC 2.5 GHz FREQUENCY UP-CONVERTER FOR WIRELESS TRANSCEIVER

UPC8172TB

FEATURES

- **RECOMMENDED OPERATING FREQUENCY:**
f_{RFout} = 0.8 to 2.5 GHz
- **SUPPLY VOLTAGE:**
V_{CC} = 2.7 to 3.3 V
- **HIGHER IP₃ AND CONVERSION GAIN:**
CG = 9.5 dB TYP
OIP₃ = +7.5 dBm TYP @ f_{RFout} = 0.9 GHz
- **HIGH-DENSITY SURFACE MOUNTING:**
6-pin super minimold package

DESCRIPTION

NEC's UPC8172TB is a silicon monolithic integrated circuit designed as a frequency up-converter for a wireless transceiver transmitter stage. This IC is manufactured using NEC's 30 GHz f_{max} UHS0 (Ultra High Speed Process) silicon bipolar process. This IC has the same circuit current as the conventional UPC8106TB, but operates at higher frequency, higher gain and lower distortion. Such performance and operation from a 3 volts supply makes this device ideal for mobile communications and wireless LAN applications.

NEC's stringent quality assurance and test procedures ensure the highest reliability and performance.

ELECTRICAL CHARACTERISTICS

(T_A = 25°C, V_{CC} = V_{RFOUT} = 3.0 V, f_{iFin} = 240 MHz, P_{LOin} = -5 dBm, and V_{PS} ≥ 2.7 V unless otherwise specified))

PART NUMBER PACKAGE OUTLINE			UPC8172TB S06			
SYMBOLS	PARAMETERS AND CONDITIONS ¹		UNITS	MIN	TYP	MAX
I _{CC}	Circuit Current (no signal)		mA	5.5	9.0	13.0
I _{CC(PS)}	Circuit Current in Power Save Mode, V _{PS} = 0 V		μA	–	–	2
CG1	Conversion Gain,	f _{RFout} = 0.9 GHz, P _{iFin} = -30 dBm	dB	6.5	9.5	12.5
CG2		f _{RFout} = 1.9 GHz, P _{iFin} = -30 dBm	dB	5.5	8.5	11.5
CG3		f _{RFout} = 2.4 GHz, P _{iFin} = -30 dBm	dB	5.0	8.0	11.0
P _{O(SAT)1}	Saturated RF Output Power,	f _{RFout} = 0.9 GHz, P _{iFin} = 0 dBm	dBm	-2.5	0.5	–
P _{O(SAT)2}		f _{RFout} = 1.9 GHz, P _{iFin} = 0 dBm	dBm	-3.5	0	–
P _{O(SAT)3}		f _{RFout} = 2.4 GHz, P _{iFin} = 0 dBm	dBm	-4.0	-0.5	–
Output Third-Order Distortion Intercept Point,						
OIP ₃₁	f _{RFout} = 0.9 GHz	f _{iFin1} = 240 MHz	dBm	–	7.5	–
OIP ₃₂	f _{RFout} = 1.9 GHz	f _{iFin2} = 241 MHz	dBm	–	6.0	–
OIP ₃₃	f _{RFout} = 2.4 GHz		dBm	–	4.0	–
Input Third-Order Distortion Intercept Point,						
IIP ₃₁	f _{RFout} = 0.9 GHz	f _{iFin1} = 240 MHz	dBm	–	-2.0	–
IIP ₃₂	f _{RFout} = 1.9 GHz	f _{iFin2} = 241 MHz	dBm	–	-2.5	–
IIP ₃₃	f _{RFout} = 2.4 GHz		dBm	–	-4.0	–
SSB·NF1	SSB Noise Figure,	f _{RFout} = 0.9 GHz, f _{iFin1} = 240 MHz	dB	–	9.5	–
SSB·NF2		f _{RFout} = 1.9 GHz, f _{iFin1} = 240 MHz	dB	–	10.4	–
SSB·NF3		f _{RFout} = 2.4 GHz, f _{iFin1} = 240 MHz	dB	–	10.6	–
TPS(rise)	Power Save Response Time		Rise Time, V _{PS} : GND' V _{CC}	μs	1	–
TPS(fall)			Fall Time, V _{PS} : V _{CC} ' GND	μs	1.5	–

Note:

1. f_{RFout} < f_{LOin} @ f_{RFout} = 0.9 GHz
f_{LOin} < f_{RFout} @ f_{RFout} = 1.9 GHz/2.4 GHz

BLOCK DIAGRAM

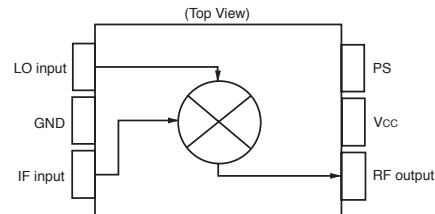

APPLICATIONS

- PCS1900 MHz
- 2.4 GHz band transmitter/receiver system (wireless LAN, etc.)

UPC8172TB

ABSOLUTE MAXIMUM RATINGS¹

(T_A = +25°C unless otherwise specified)

SYMBOLS	PARAMETERS	UNITS	RATINGS
V _{CC}	Supply Voltage	V	3.6
V _{PS}	PS Pin Input Voltage	V	3.6
P _D	Power Dissipation ²	mW	270
T _A	Operating Ambient Temperature	°C	-40 to +85
T _{STG}	Storage Temperature	°C	-55 to +150
P _{IN}	Input Power	dBm	+10

Notes:

- Operation in excess of any one of these conditions may result in permanent damage.
- Mounted on a double-sided copper clad 50x50x1.6 mm epoxy glass PWB, T_A = +85°C.

RECOMMENDED OPERATING CONDITIONS

SYMBOLS	PARAMETERS	UNITS	MIN	TYP	MAX
V _{CC}	Supply Voltage ¹	V	2.7	3.0	3.3
T _A	Operating Ambient Temperature	°C	-40	+25	+85
P _{LOin}	Local Input Level ²	dBm	-10	-5	0
f _{RFout}	RF Output Frequency ³	GHz	0.8	–	2.5
f _{iFin}	IF Input Frequency	MHz	50	–	400

Note:

- Same voltage applied to pins 5 and 6.
- Z_s = 50 Ω (without matching).
- With external matching circuit.

SERIES PRODUCTS¹ (T_A = +25°C, V_{CC} = V_{RFout} = 3.0 V, Z_S = Z_L = 50 Ω)

Part Number	I _{CC} (mA)	f _{RFout} (GHz)	CG (dB)			OIP ₃ (dBm)		
			@RF 0.9 GHz ²	@RF 1.9 GHz	@RF 2.4 GHz	@RF 0.9 GHz ²	@RF 1.9 GHz	@RF 2.4 GHz
UPC8172TB	9	0.8 to 2.5	9.5	8.5	8.0	+7.5	+6.0	+4.0
UPC8106TB	9	0.4 to 2.0	9	7	–	+5.5	-1.0	–
UPC8109TB	5	0.4 to 2.0	6	4	–	+1.5	+2.0	–
UPC8163TB	16.5	0.8 to 2.0	9	5.5	–	+9.5	+6.0	–

Notes:

- Typical performance.
- f_{RFout} = 0.83 GHz @ UPC8163TB

PIN FUNCTIONS (Voltage is measured at V_{CC} = V_{PS} = V_{RFOUT} = 3.0 V)

Pin No.	Pin Name	Applied Voltage (V)	Pin Voltage (V)	Function and Explanation	Equivalent Circuit						
1	IFinput	–	1.4	This pin is the IF input pin to the double balanced mixer (DBM). The input is designed as a high impedance. The circuit helps suppress spurious signals. Also this symmetrical circuit can keep specified performance insensitive to process-condition distribution. For that reason, a double balanced mixer is adopted.							
2	GND	GND	–	GND pin. Ground pattern on the board should be formed as wide as possible. Track length should be kept as short as possible to minimize ground inductance.							
3	LOinput	–	2.3	Local input pin. Recommendable input level is -10 to 0 dBm.							
5	V _{CC}	2.7 to 3.3	–	Supply voltage pin.							
6	RFoutput	Same bias as V _{CC} through external inductor	–	This pin is the RF output from the double balanced mixer. This pin is designed as an open collector. Due to the high impedance output, this pin should be externally equipped with an LC matching circuit to the next stage.							
4	PS	V _{CC} /GND		Power save control pin. Bias controls operate as follows: <table border="1" style="margin: 10px auto;"> <thead> <tr> <th>Pin Bias</th> <th>Control</th> </tr> </thead> <tbody> <tr> <td>V_{CC}</td> <td>Operation</td> </tr> <tr> <td>GND</td> <td>Power Save</td> </tr> </tbody> </table>	Pin Bias	Control	V _{CC}	Operation	GND	Power Save	
Pin Bias	Control										
V _{CC}	Operation										
GND	Power Save										

TYPICAL PERFORMANCE CURVES (TA = 25°C)

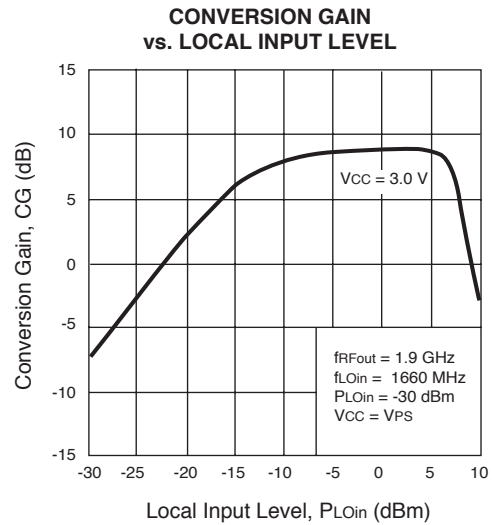
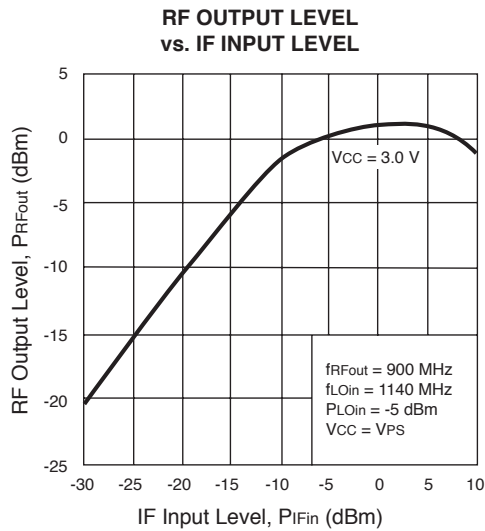
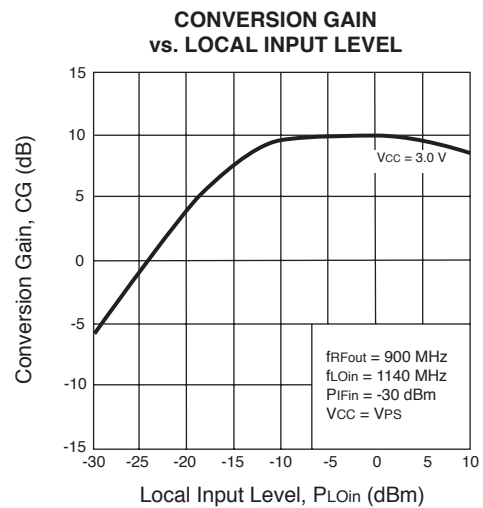
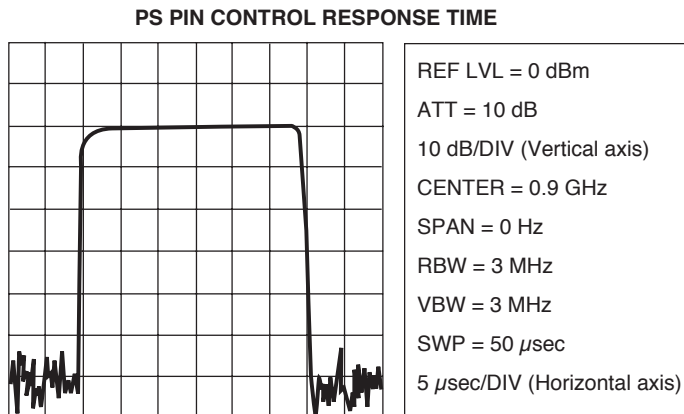
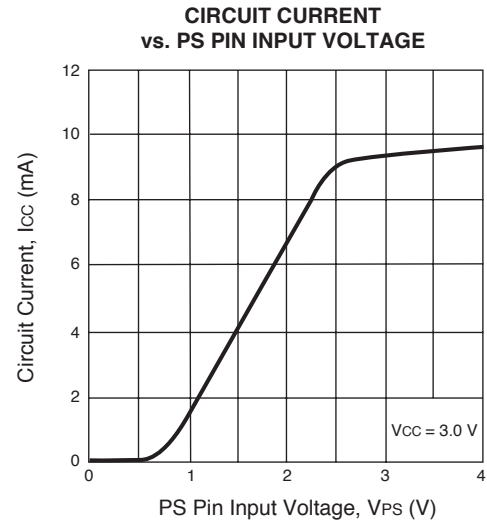
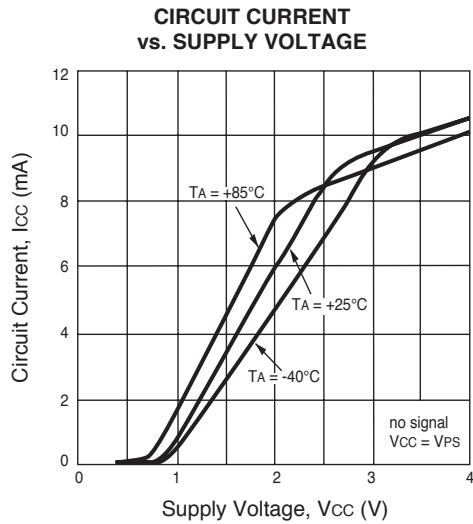

TYPICAL PERFORMANCE CURVES (TA = 25°C)

RF OUTPUT LEVEL vs. IF INPUT LEVEL

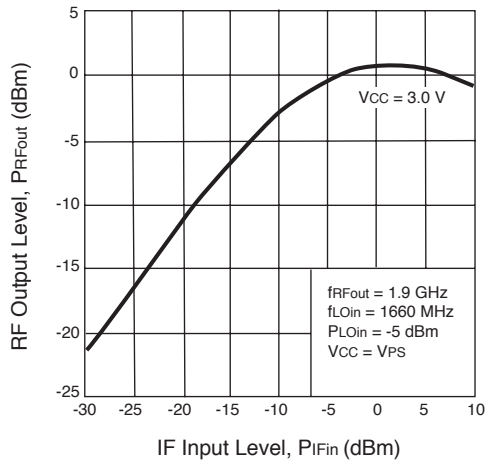

CONVERSION GAIN vs. LOCAL INPUT LEVEL

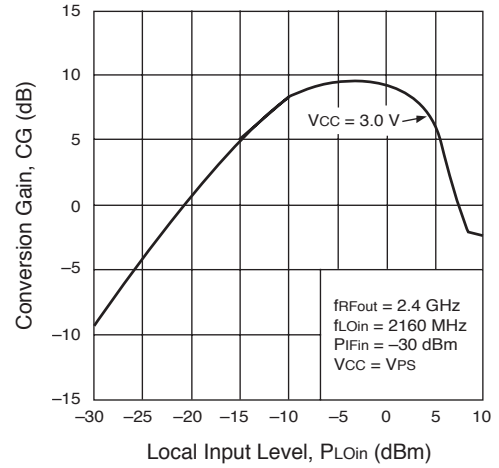

RF OUTPUT LEVEL vs. IF INPUT LEVEL

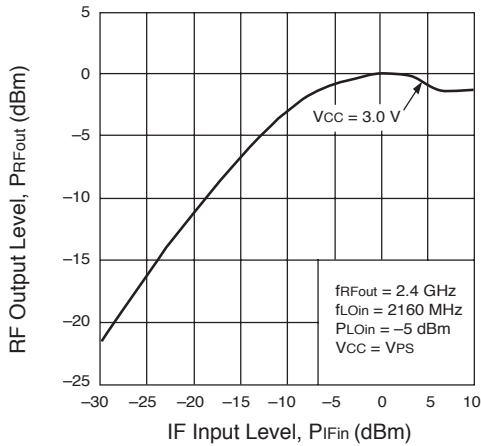

IM3, RF OUTPUT LEVEL vs. IF INPUT LEVEL

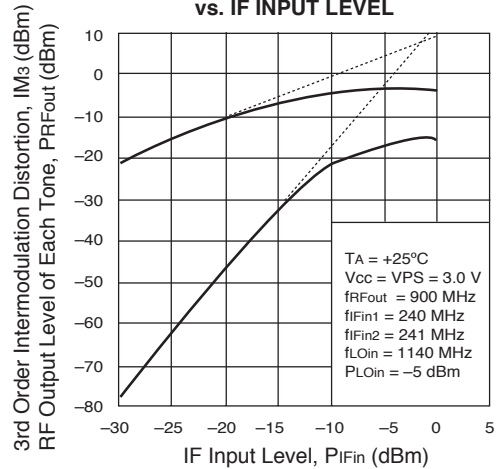

IM3, RF OUTPUT LEVEL vs. IF INPUT LEVEL

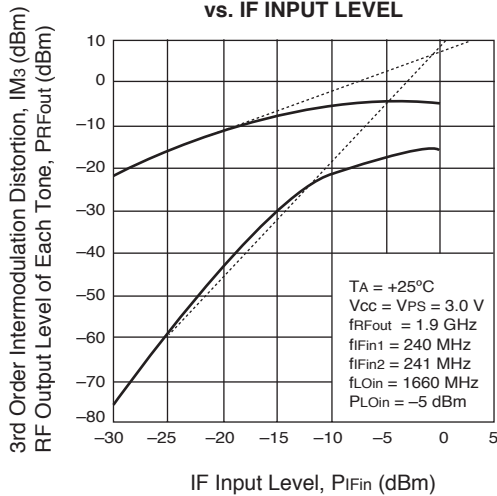

IM3, RF OUTPUT LEVEL vs. IF INPUT LEVEL

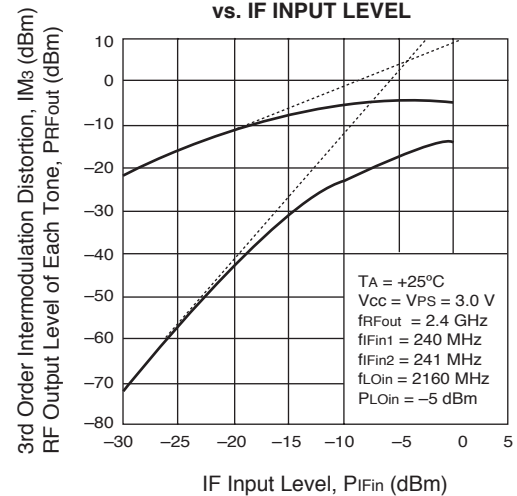

TYPICAL PERFORMANCE CURVES (TA = 25°C)

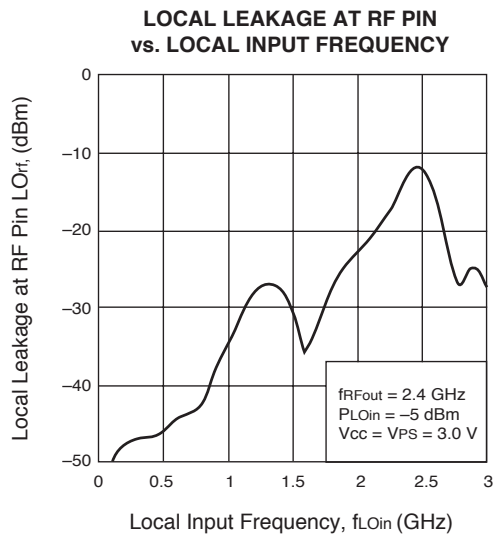
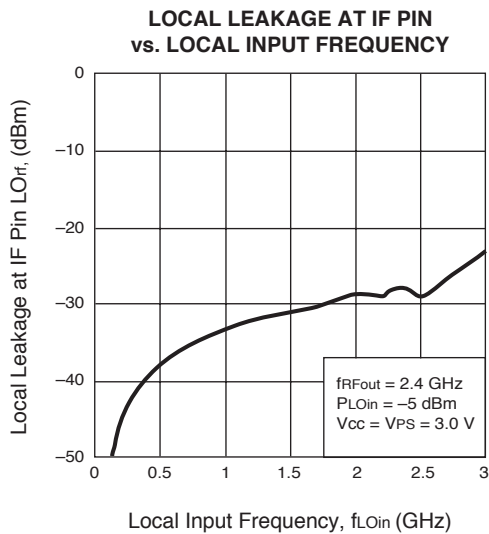
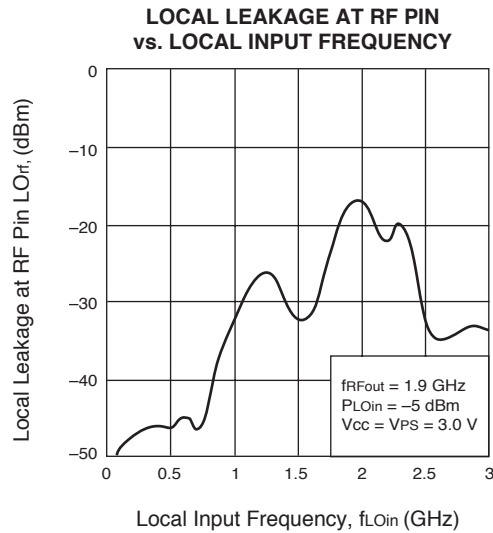
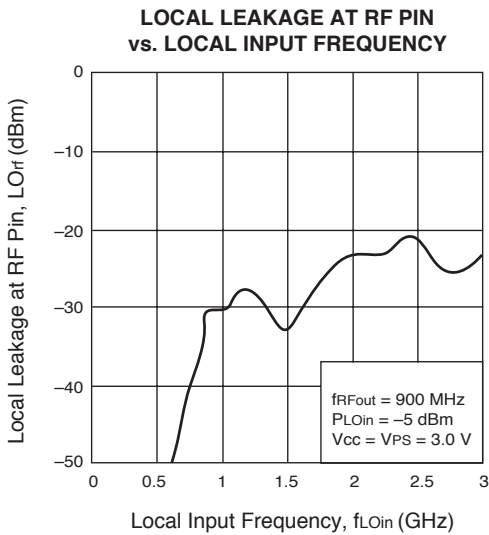
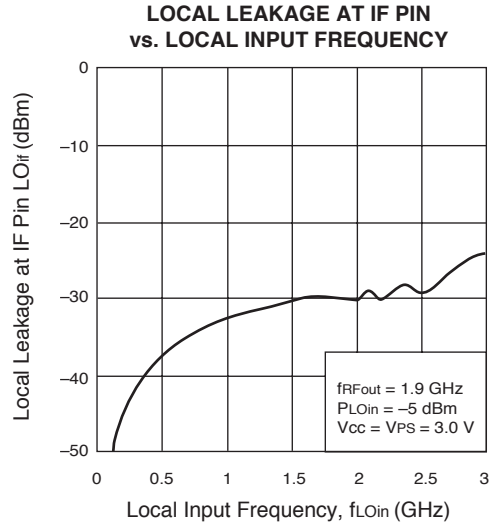
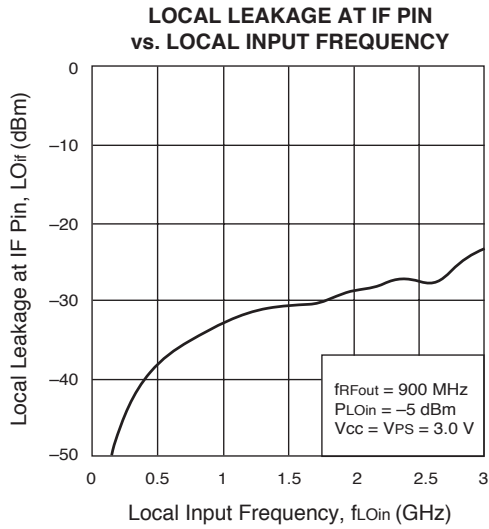

SYSTEM APPLICATION EXAMPLE

Wireless Transceiver

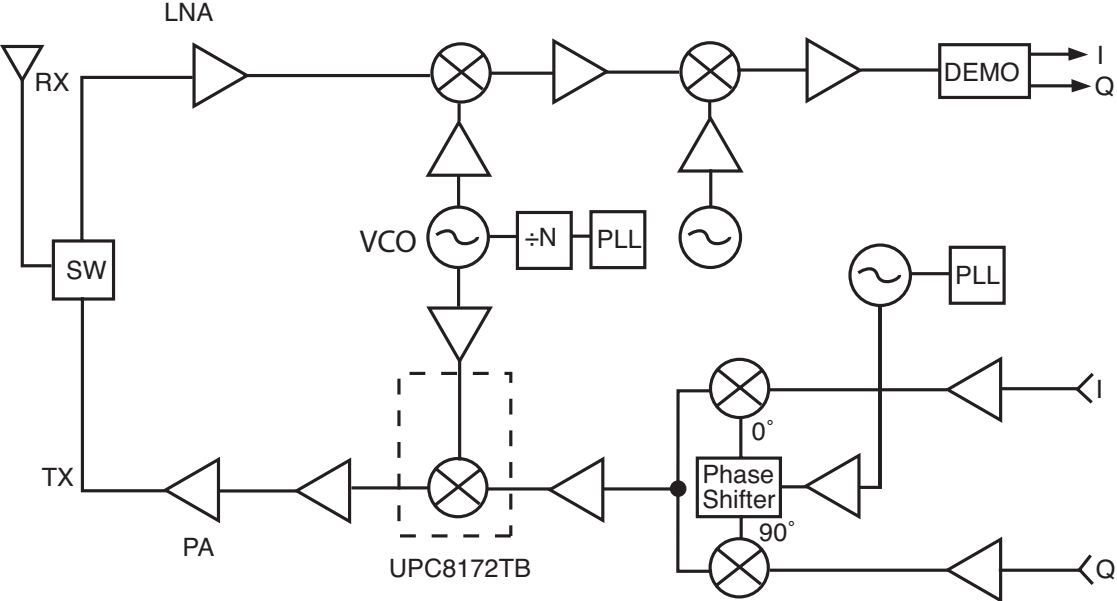

S-PARAMETERS FOR EACH PORT ($V_{CC} = V_{PS} = V_{RFout} = 3.0\text{ V}$)

(The paramters are monitored at DUT pins)

LO port

S₁₁ Z
 REF 1.0 Units
 1 200.0 mUnits/
 ▽ 21.625 Ω -91.148 Ω

hp
 MARKER 1
 1.15 GHz
 MARKER 2
 1.65 GHz
 MARKER 3
 2.15 GHz

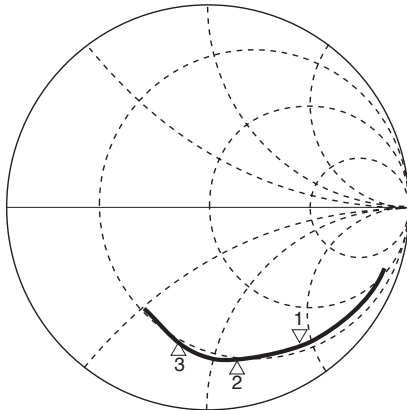

START 0.40000000 GHz
 STOP 2.50000000 GHz

RF port (without matching)

S₂₂ Z
 REF 1.0 Units
 1 200.0 mUnits/
 ▽ 71.5 Ω -240.34 Ω

hp
 MARKER 1
 900 MHz
 MARKER 2
 1.9 GHz
 MARKER 3
 2.5 GHz

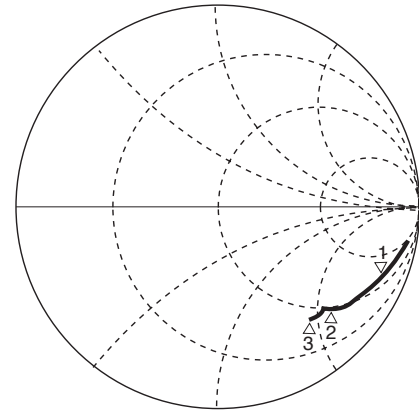

START 0.40000000 GHz
 STOP 2.50000000 GHz

IF port

S₁₁ Z
 REF 1.0 Units
 1 200.0 mUnits/
 ▽ 332.63 Ω -601.34 Ω

hp
 MARKER 1
 240.0 MHz

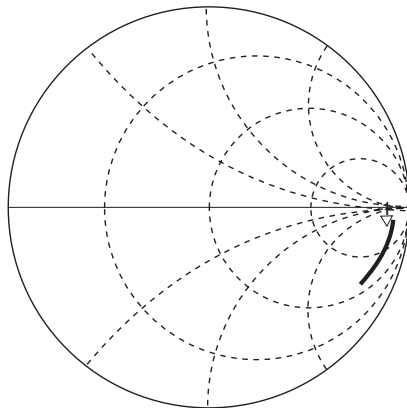

START 0.10000000 GHz
 STOP 1.00000000 GHz

TEST CIRCUIT 1 ($f_{RFout} = 900 \text{ MHz}$)

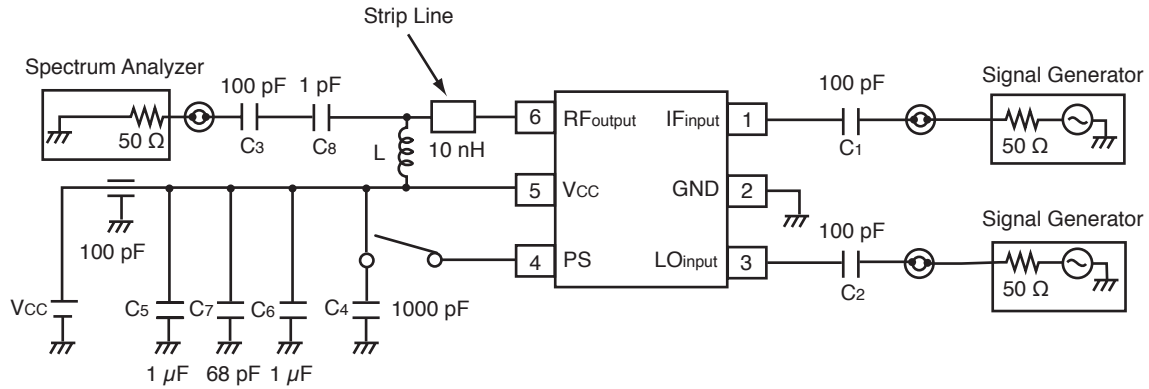

EXAMPLE OF TEST CIRCUIT 1 ASSEMBLED ON EVALUATION BOARD

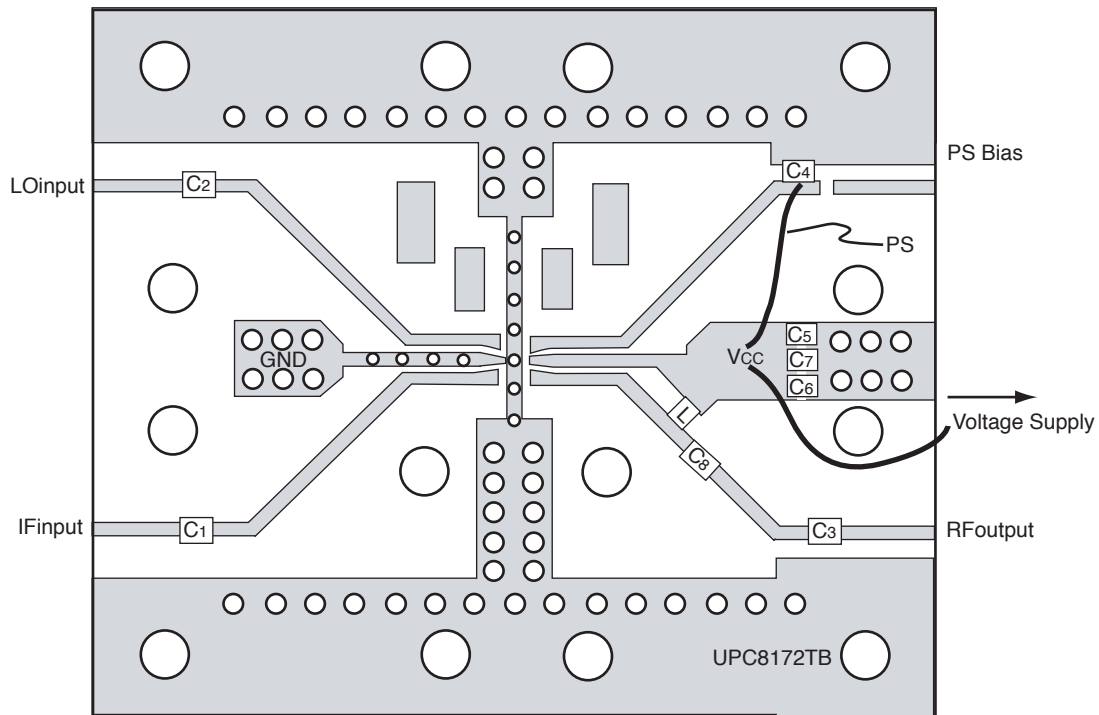

COMPONENT LIST

FORM	SYMBOL	VALUE
Chip Capacitor	C1, C2, C3	100 pF
	C4	1000 pF
	C5, C6	1 μF
	C7	68 pF
	C8	1 pF
	Chip Inductor	L

- (*1) 35x42x0.4 mm polyimide board, double-sided copper clad
- (*2) Ground pattern on rear of the board
- (*3) Solder plated patterns
- (*4) mmIII : Through holes

Note:

1. 10 nH: LL1608-FH10N (TOKO Co., Ltd.)

TEST CIRCUIT 2 ($f_{RFout} = 1.9\text{ GHz}$)

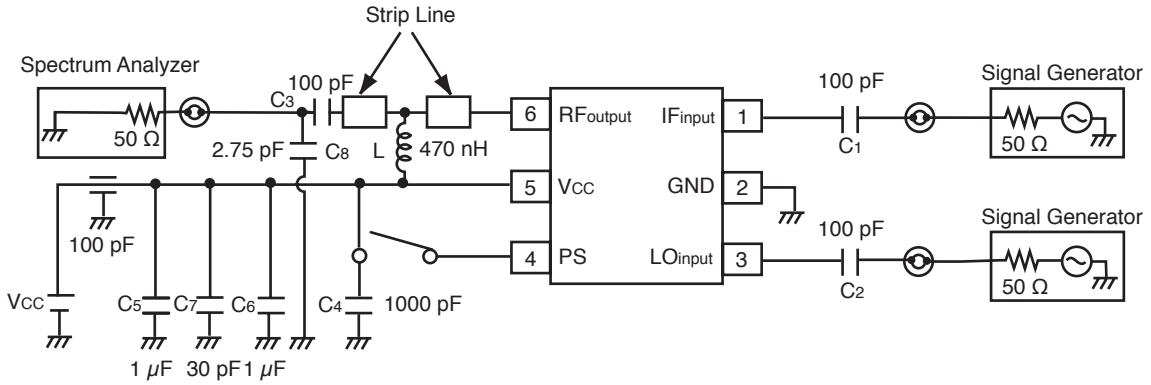

EXAMPLE OF TEST CIRCUIT 2 ASSEMBLED ON EVALUATION BOARD

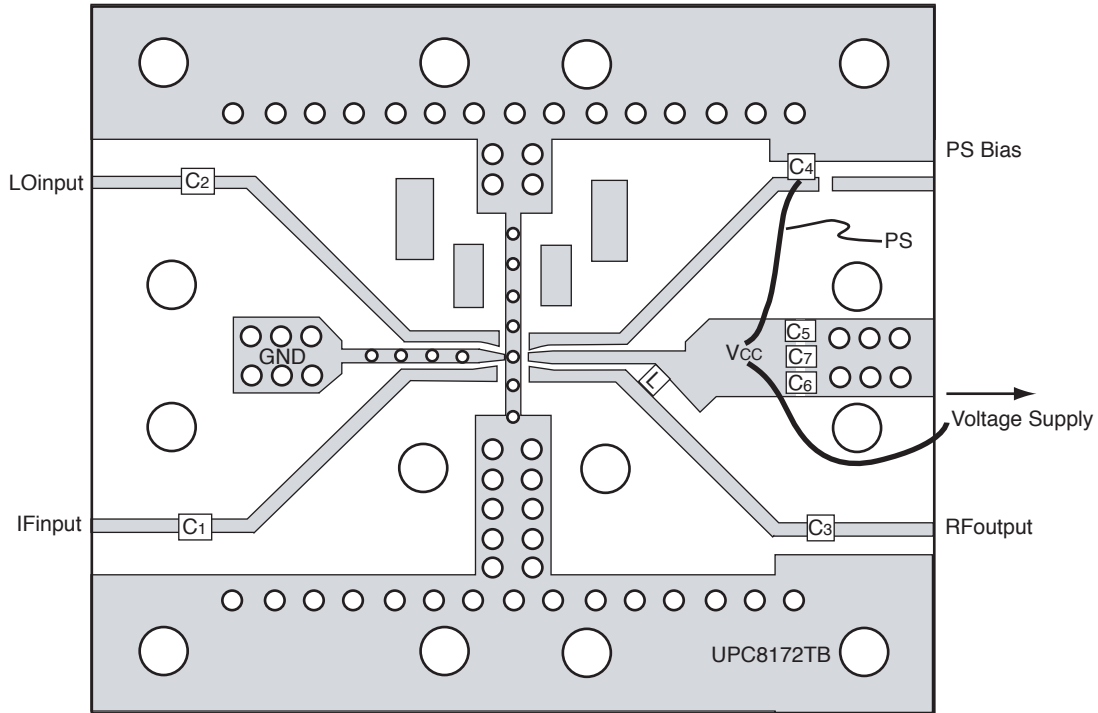

COMPONENT LIST

FORM	SYMBOL	VALUE
Chip Capacitor	C1, C2, C3	100 pF
	C4	1000 pF
	C5, C6	1 μ F
	C7	30 pF
	C8	2.75 pF
Chip Inductor	L	470 nH ¹

- (*1) 35 x 42 x 0.4 mm polyimide board, double-sided copper clad
- (*2) Ground pattern on rear of the board
- (*3) Solder plated patterns
- (*4) mmI : Through holes

Note:

1. 470 nH: LL2012-FR47 (TOKO Co., Ltd.)

TEST CIRCUIT 3 ($f_{RFout} = 2.4 \text{ GHz}$)

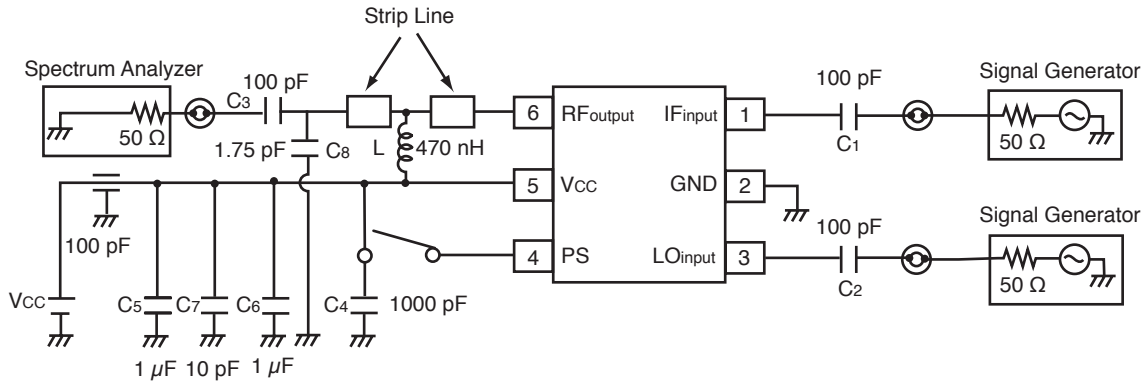

EXAMPLE OF TEST CIRCUIT 3 ASSEMBLED ON EVALUATION BOARD

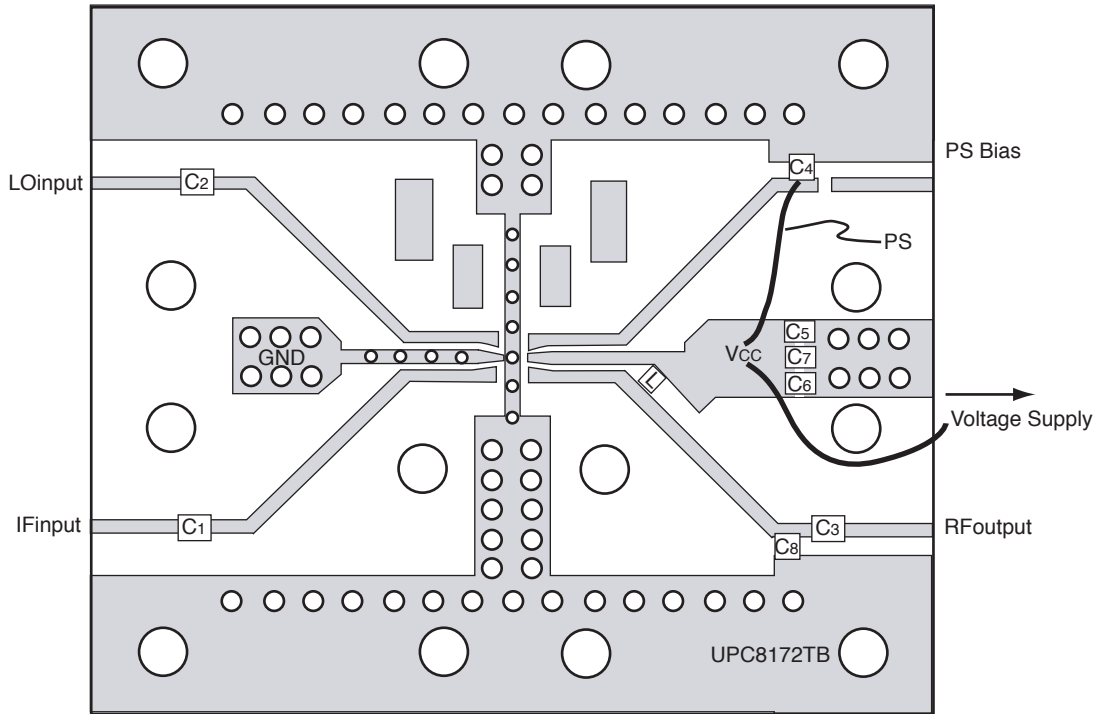

COMPONENT LIST

FORM	SYMBOL	VALUE
Chip Capacitor	C1, C2, C3	100 pF
	C4	1000 pF
	C5, C6	1 μ F
	C7	10 pF
	C8	1.75 pF
	Chip Inductor	L

- (*1) 35 x 42 x 0.4 mm polyimide board, double-sided copper clad
- (*2) Ground pattern on rear of the board
- (*3) Solder plated patterns
- (*4) mmM : Through holes

Note:

1. 470 nH: LL2012-FR47 (TOKO Co., Ltd.)

OUTLINE DIMENSIONS (Units in mm)

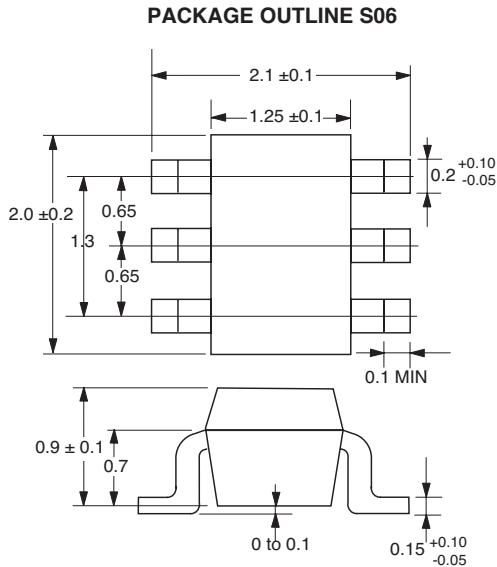

Note:
All dimensions are typical unless otherwise specified.

BLOCK DIAGRAM

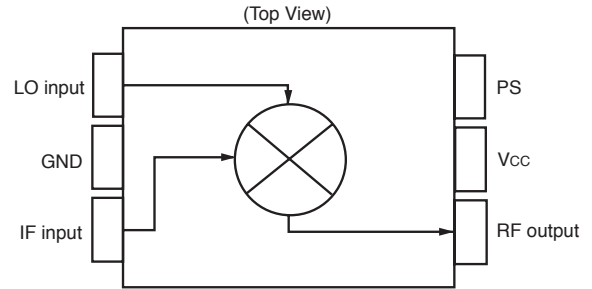

PIN CONNECTIONS

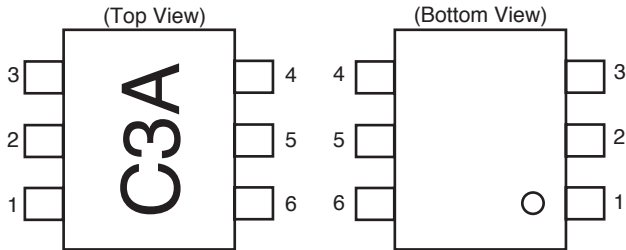

PIN NO.	PIN NAME
1	IFinput
2	GND
3	LOinput
4	PS
5	Vcc
6	RFoutput

ORDERING INFORMATION

Part Number	Quantity
UPC8172TB-E3-A	3 K pcs/reel

Note: Embossed tape, 8 mm wide. Pins 1, 2 and 3 face the tape perforation side.

Life Support Applications

These NEC products are not intended for use in life support devices, appliances, or systems where the malfunction of these products can reasonably be expected to result in personal injury. The customers of CEL using or selling these products for use in such applications do so at their own risk and agree to fully indemnify CEL for all damages resulting from such improper use or sale.

EXCLUSIVE NORTH AMERICAN AGENT FOR **NEC** RF, MICROWAVE & OPTOELECTRONIC SEMICONDUCTORS

CEL CALIFORNIA EASTERN LABORATORIES • Headquarters • 4590 Patrick Henry Drive • Santa Clara, CA 95054-1817 • (408) 988-3500 • Telex 34-6393 • FAX (408) 988-0279
24-Hour Fax-On-Demand: 800-390-3232 (U.S. and Canada only) • Internet: <http://WWW.CEL.COM>

DATA SUBJECT TO CHANGE WITHOUT NOTICE

06/14/2001

Subject: Compliance with EU Directives

CEL certifies, to its knowledge, that semiconductor and laser products detailed below are compliant with the requirements of European Union (EU) Directive 2002/95/EC Restriction on Use of Hazardous Substances in electrical and electronic equipment (RoHS) and the requirements of EU Directive 2003/11/EC Restriction on Penta and Octa BDE.

CEL Pb-free products have the same base part number with a suffix added. The suffix –A indicates that the device is Pb-free. The –AZ suffix is used to designate devices containing Pb which are exempted from the requirement of RoHS directive (*). In all cases the devices have Pb-free terminals. All devices with these suffixes meet the requirements of the RoHS directive.

This status is based on CEL’s understanding of the EU Directives and knowledge of the materials that go into its products as of the date of disclosure of this information.

Restricted Substance per RoHS	Concentration Limit per RoHS (values are not yet fixed)	Concentration contained in CEL devices	
		-A	-AZ
Lead (Pb)	< 1000 PPM	Not Detected	(*)
Mercury	< 1000 PPM	Not Detected	
Cadmium	< 100 PPM	Not Detected	
Hexavalent Chromium	< 1000 PPM	Not Detected	
PBB	< 1000 PPM	Not Detected	
PBDE	< 1000 PPM	Not Detected	

If you should have any additional questions regarding our devices and compliance to environmental standards, please do not hesitate to contact your local representative.

Important Information and Disclaimer: Information provided by CEL on its website or in other communications concerning the substance content of its products represents knowledge and belief as of the date that it is provided. CEL bases its knowledge and belief on information provided by third parties and makes no representation or warranty as to the accuracy of such information. Efforts are underway to better integrate information from third parties. CEL has taken and continues to take reasonable steps to provide representative and accurate information but may not have conducted destructive testing or chemical analysis on incoming materials and chemicals. CEL and CEL suppliers consider certain information to be proprietary, and thus CAS numbers and other limited information may not be available for release.

In no event shall CEL’s liability arising out of such information exceed the total purchase price of the CEL part(s) at issue sold by CEL to customer on an annual basis.

See CEL Terms and Conditions for additional clarification of warranties and liability.