



NEC's NPN SiGe RF TRANSISTOR FOR MEDIUM OUTPUT POWER AMPLIFICATION (800 mW) 3-PIN POWER MINIMOLD (34 PACKAGE)

NESG250134

FEATURES

- **THIS PRODUCT IS SUITABLE FOR MEDIUM OUTPUT POWER (800 mW) AMPLIFICATION**
 $P_o = 29 \text{ dBm TYP. @ } V_{CE} = 3.6 \text{ V, } P_{in} = 15 \text{ dBm, } f = 460 \text{ MHz}$
 $P_o = 29 \text{ dBm TYP. @ } V_{CE} = 3.6 \text{ V, } P_{in} = 20 \text{ dBm, } f = 900 \text{ MHz}$
- **MAXIMUM STABLE GAIN:**
 $MSG = 23 \text{ dB TYP @ } V_{CE} = 3.6 \text{ V, } I_c = 100 \text{ mA, } f = 460 \text{ MHz}$
- **SiGe TECHNOLOGY:**
 UHS2-HV process
- **ABSOLUTE MAXIMUM RATINGS:**
 $V_{CBO} = 20 \text{ V}$
- **3-PIN POWER MINIMOLD (34 PACKAGE)**

ORDERING INFORMATION

PART NUMBER	ORDER NUMBER	PACKAGE	QUANTITY	SUPPLYING FORM
NESG250134-AZ	NESG250134-AZ	3-pin power minimold (Pb-Free) ^{Note1}	25 pcs (Non reel)	• 12 mm wide embossed taping • Pin 2 (Emitter) face the perforation side of the tape
NESG250134-T1-AZ	NESG250134-T1-AZ		1 kpcs/reel	

Note 1. Contains lead in the part except the electrode terminals.

Remark To order evaluation samples, contact your nearby sales office.
 Unit sample quantity is 25 pcs.

ABSOLUTE MAXIMUM RATINGS ($T_A = +25^\circ\text{C}$)

PARAMETER	SYMBOL	RATINGS	UNIT
Collector to Base Voltage	V_{CBO}	20	V
Collector to Emitter Voltage	V_{CEO}	9.2	V
Emitter to Base Voltage	V_{EBO}	2.8	V
Collector Current	I_c	500	mA
Total Power Dissipation	P_{tot} ^{Note}	1.5	W
Junction Temperature	T_j	150	$^\circ\text{C}$
Storage Temperature	T_{stg}	-65 to +150	$^\circ\text{C}$

Note Mounted on $34.2 \text{ cm}^2 \times 0.8 \text{ mm (t)}$ glass epoxy PWB

Caution Observe precautions when handling because these devices are sensitive to electrostatic discharge.

THERMAL RESISTANCE ($T_A = 25^\circ\text{C}$)

PARAMETER	SYMBOL	RATINGS	UNIT
Thermal Resistance from Junction to Ambient ^{Note}	R_{thj-a}	80	$^\circ\text{C/W}$

Note Mounted on $34.2\text{ cm}^2 \times 0.8\text{ mm}$ (t) glass epoxy PWB

RECOMMENDED OPERATING RANGE ($T_A = 25^\circ\text{C}$)

PARAMETER	SYMBOL	MIN.	TYP.	MAX.	UNIT
Collector to Emitter Voltage	V_{CE}	–	3.6	4.5	V
Collector Current	I_C	–	400	500	mA
Input Power ^{Note}	P_{in}	–	12	17	dBm

Note Input power under conditions of $V_{CE} \leq 4.5\text{ V}$, $f = 460\text{ MHz}$

ELECTRICAL CHARACTERISTICS ($T_A = 25^\circ\text{C}$)

PARAMETER	SYMBOL	TEST CONDITIONS	MIN.	TYP.	MAX.	UNIT
DC Characteristics						
Collector Cut-off Current	I_{CBO}	$V_{CB} = 5\text{ V}, I_E = 0\text{ mA}$	–	–	1	μA
Emitter Cut-off Current	I_{EBO}	$V_{EB} = 0.5\text{ V}, I_C = 0\text{ mA}$	–	–	1	μA
DC Current Gain	h_{FE} ^{Note 1}	$V_{CE} = 3\text{ V}, I_C = 100\text{ mA}$	80	120	180	–
RF Characteristics						
Gain Bandwidth Product	f_T	$V_{CE} = 3.6\text{ V}, I_C = 100\text{ mA}, f = 460\text{ MHz}$	–	10	–	GHz
Insertion Power Gain	$ S_{21e} ^2$	$V_{CE} = 3.6\text{ V}, I_C = 100\text{ mA}, f = 460\text{ MHz}$	–	19	–	dB
Maximum Stable Gain	MSG ^{Note 2}	$V_{CE} = 3.6\text{ V}, I_C = 100\text{ mA}, f = 460\text{ MHz}$	–	23	–	dB
Linear gain (1)	G_L	$V_{CE} = 3.6\text{ V}, I_{C(\text{set})} = 30\text{ mA (RF OFF)}, f = 460\text{ MHz}, P_{in} = 0\text{ dBm}$	16	19	–	dB
Linear gain (2)	G_L	$V_{CE} = 3.6\text{ V}, I_{C(\text{set})} = 30\text{ mA (RF OFF)}, f = 900\text{ MHz}, P_{in} = 0\text{ dBm}$	–	16	–	dB
Output Power (1)	P_O	$V_{CE} = 3.6\text{ V}, I_{C(\text{set})} = 30\text{ mA (RF OFF)}, f = 460\text{ MHz}, P_{in} = 15\text{ dBm}$	27	29	–	dBm
Output Power (2)	P_O	$V_{CE} = 3.6\text{ V}, I_{C(\text{set})} = 30\text{ mA (RF OFF)}, f = 900\text{ MHz}, P_{in} = 20\text{ dBm}$	–	29	–	dBm
Collector Efficiency (1)	η_c	$V_{CE} = 3.6\text{ V}, I_{C(\text{set})} = 30\text{ mA (RF OFF)}, f = 460\text{ MHz}, P_{in} = 15\text{ dBm}$	–	60	–	%
Collector Efficiency (2)	η_c	$V_{CE} = 3.6\text{ V}, I_{C(\text{set})} = 30\text{ mA (RF OFF)}, f = 900\text{ MHz}, P_{in} = 20\text{ dBm}$	–	60	–	%

Notes 1. Pulse measurement: $PW \leq 350\ \mu\text{s}$, Duty Cycle $\leq 2\%$

$$2. \text{MSG} = \left| \frac{S_{21}}{S_{12}} \right|$$

h_{FE} CLASSIFICATION

RANK	FB
Marking	SN
h_{FE} Value	80 to 180

TYPICAL CHARACTERISTICS ($T_A = +25^\circ\text{C}$, unless otherwise specified)

TOTAL POWER DISSIPATION vs. AMBIENT TEMPERATURE

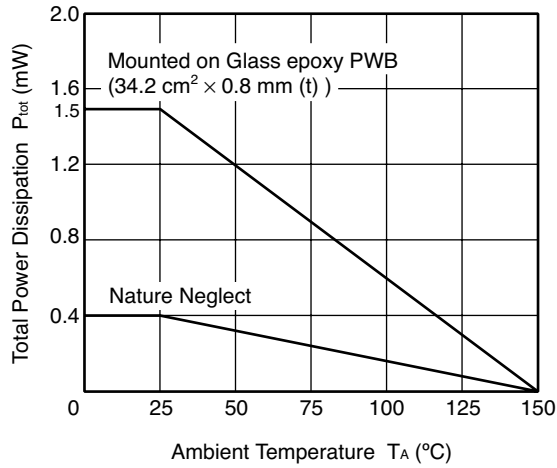

REVERSE TRANSFER CAPACITANCE vs. COLLECTOR TO BASE VOLTAGE

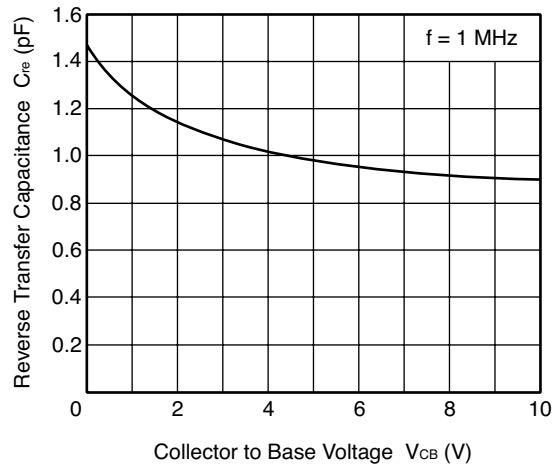

COLLECTOR CURRENT vs. BASE TO EMITTER VOLTAGE

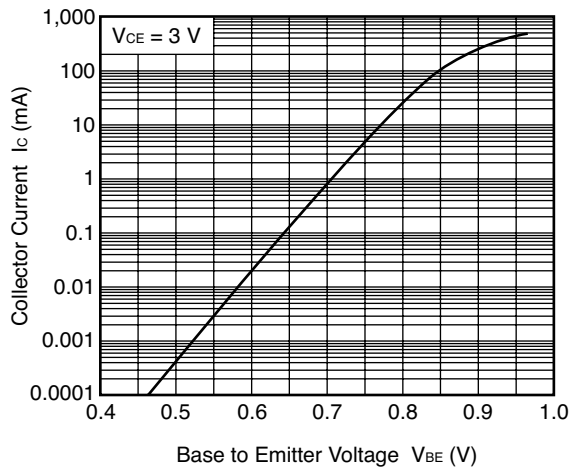

COLLECTOR CURRENT vs. BASE TO EMITTER VOLTAGE

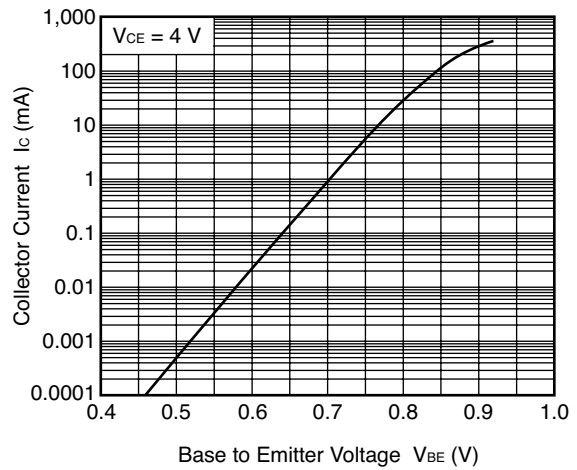

COLLECTOR CURRENT vs. COLLECTOR TO EMITTER VOLTAGE

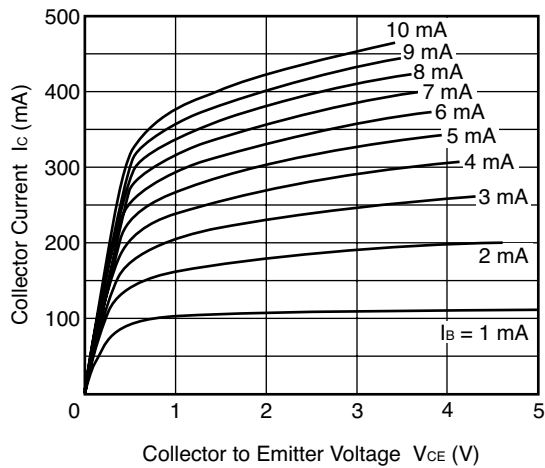

Remark The graphs indicate nominal characteristics.

DC CURRENT GAIN vs. COLLECTOR CURRENT

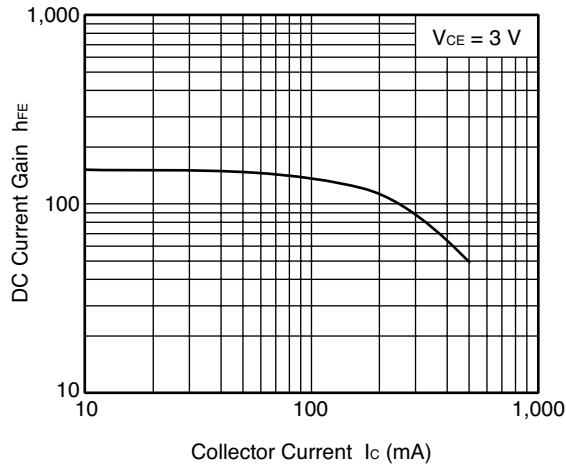

DC CURRENT GAIN vs. COLLECTOR CURRENT

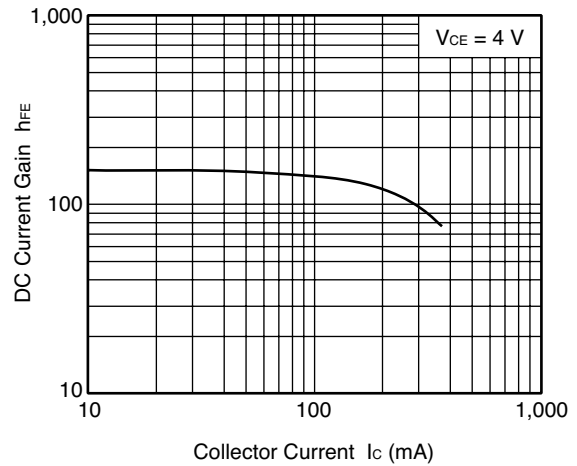

GAIN BANDWIDTH PRODUCT vs. COLLECTOR CURRENT

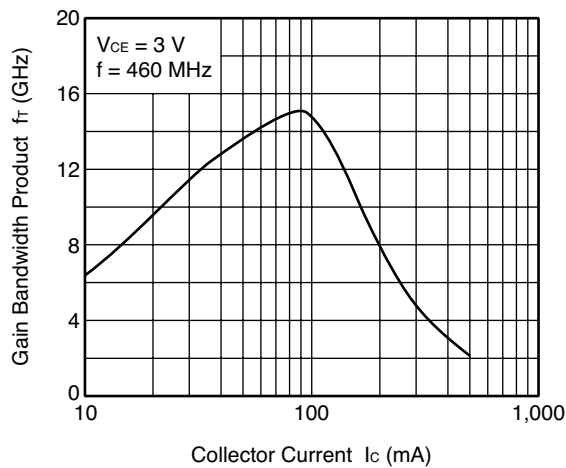

GAIN BANDWIDTH PRODUCT vs. COLLECTOR CURRENT

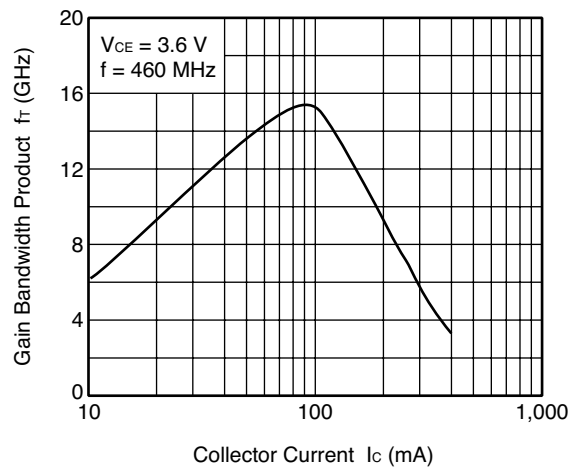

GAIN BANDWIDTH PRODUCT vs. COLLECTOR CURRENT

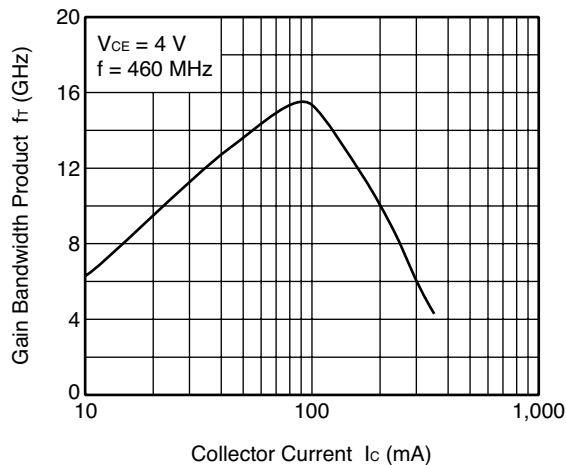

INSERTION POWER GAIN, MAG, MSG vs. FREQUENCY

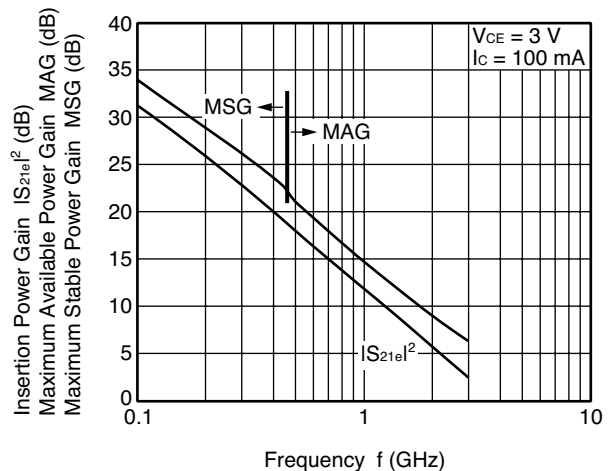

Remark The graphs indicate nominal characteristics.

INSERTION POWER GAIN, MAG, MSG vs. FREQUENCY

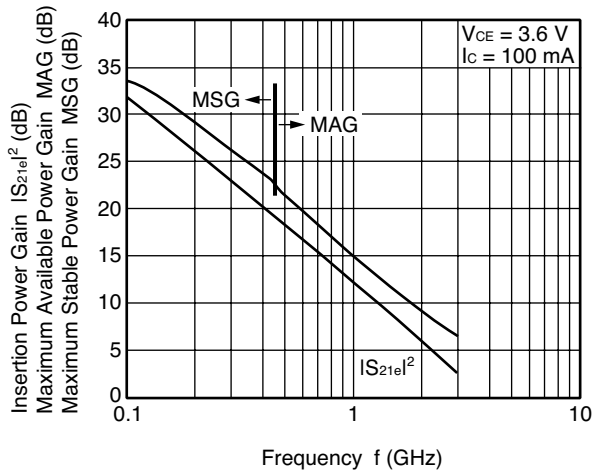

INSERTION POWER GAIN, MAG, MSG vs. FREQUENCY

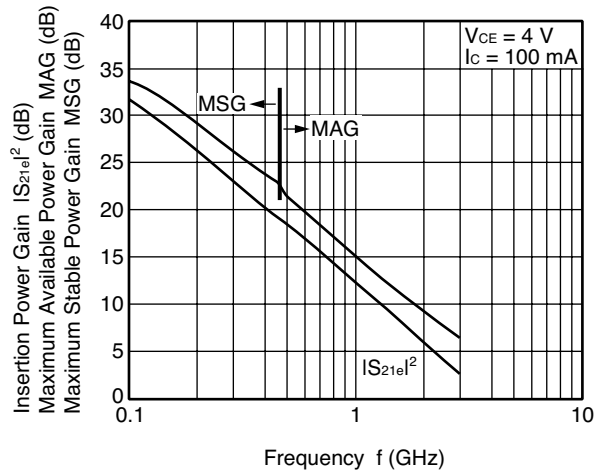

INSERTION POWER GAIN, MAG, MSG vs. COLLECTOR CURRENT

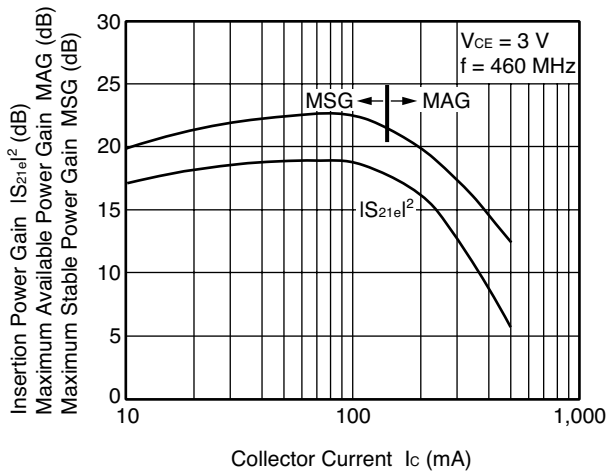

INSERTION POWER GAIN, MAG, MSG vs. COLLECTOR CURRENT

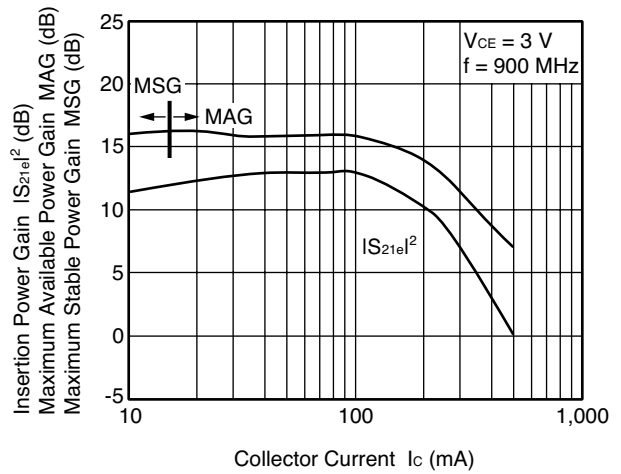

INSERTION POWER GAIN, MAG, MSG vs. COLLECTOR CURRENT

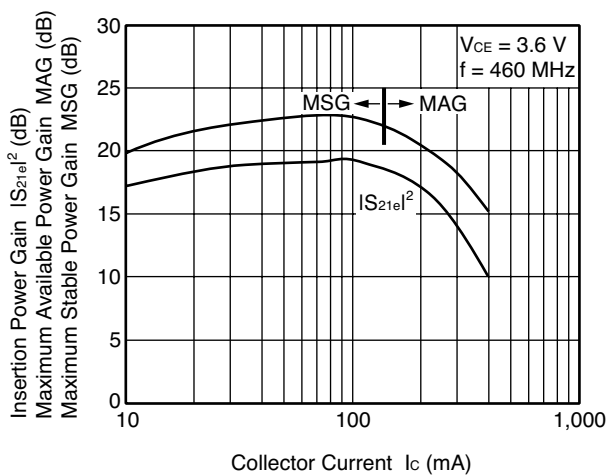

INSERTION POWER GAIN, MAG, MSG vs. COLLECTOR CURRENT

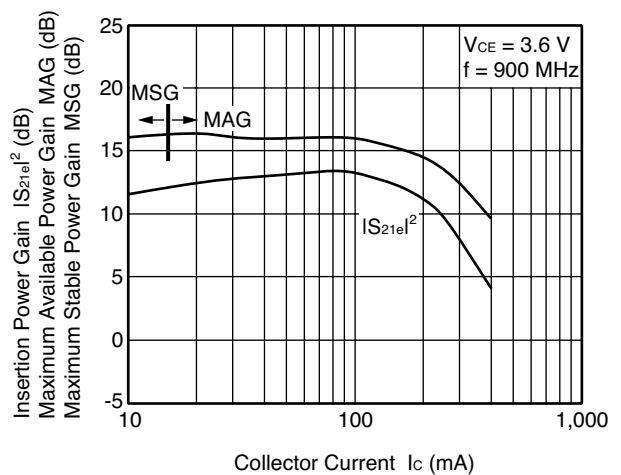

Remark The graphs indicate nominal characteristics.

INSERTION POWER GAIN, MAG, MSG vs. COLLECTOR CURRENT

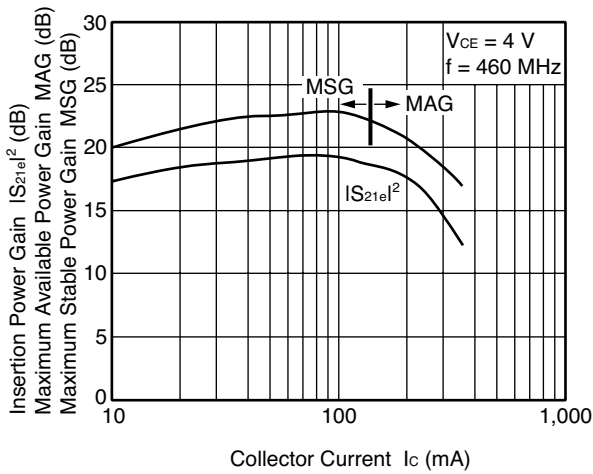

INSERTION POWER GAIN, MAG, MSG vs. COLLECTOR CURRENT

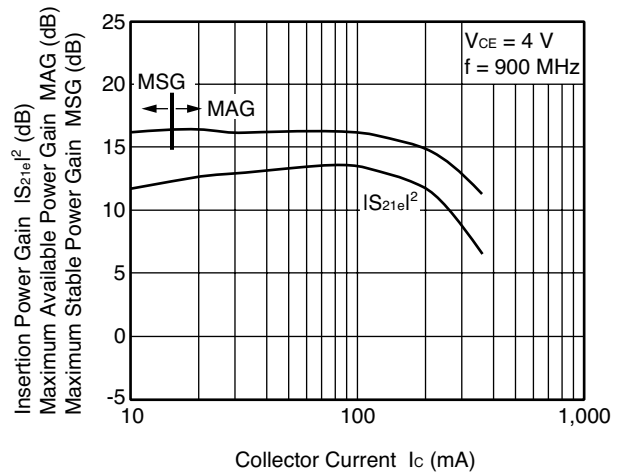

OUTPUT POWER, POWER GAIN, COLLECTOR CURRENT, COLLECTOR EFFICIENCY vs. INPUT POWER

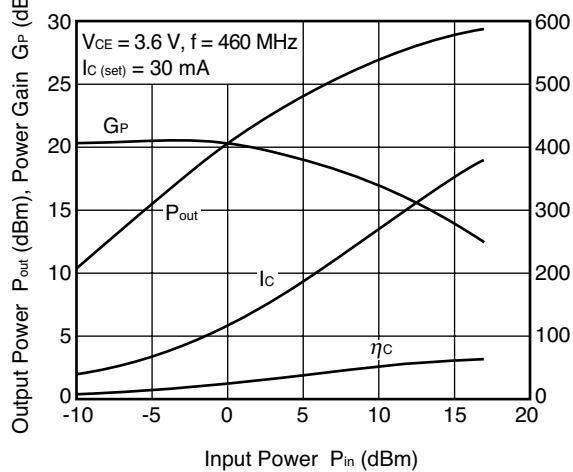

OUTPUT POWER, POWER GAIN, COLLECTOR CURRENT, COLLECTOR EFFICIENCY vs. INPUT POWER

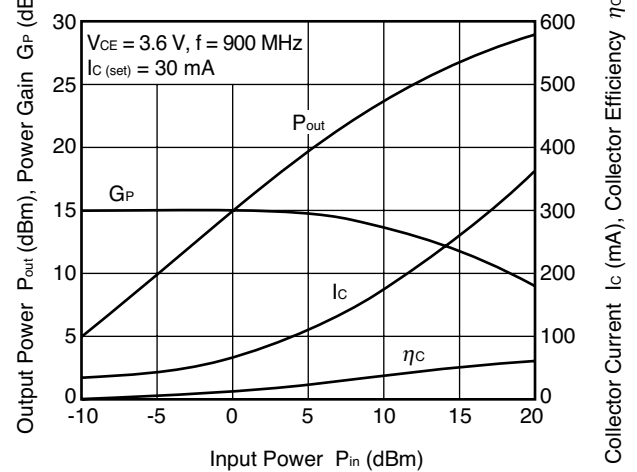

NOISE FIGURE, ASSOCIATED GAIN vs. COLLECTOR CURRENT

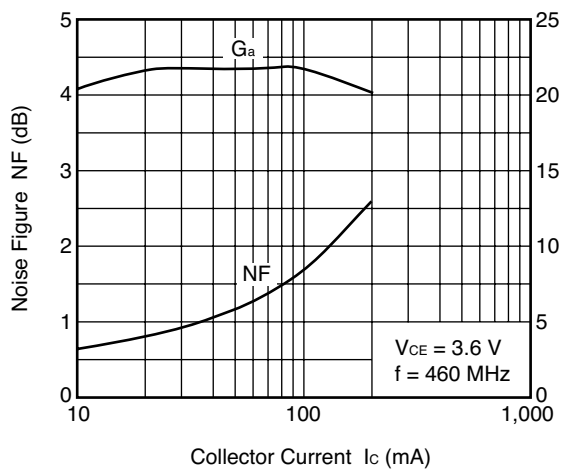

Remark The graphs indicate nominal characteristics.

PA EVALUATION BOARD (f = 460 MHz)

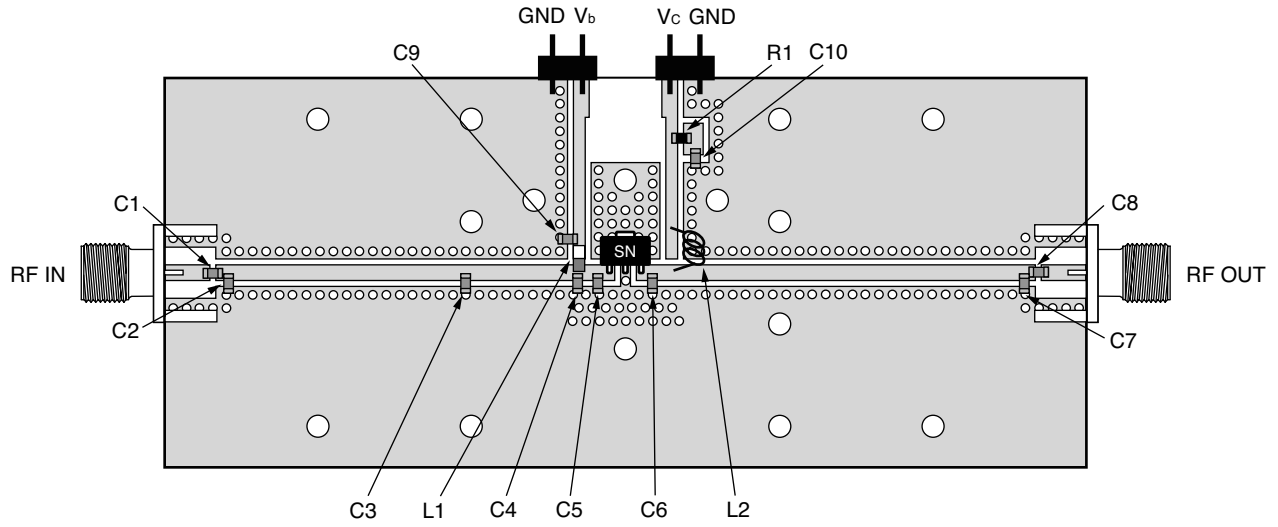

Notes

1. 38 × 90 mm, t = 0.8 mm double sided copper clad glass epoxy PWB.
2. Back side: GND pattern
3. Solder gold plated on pattern
4. ○: Through holes

PA EVALUATION CIRCUIT (f = 460 MHz)

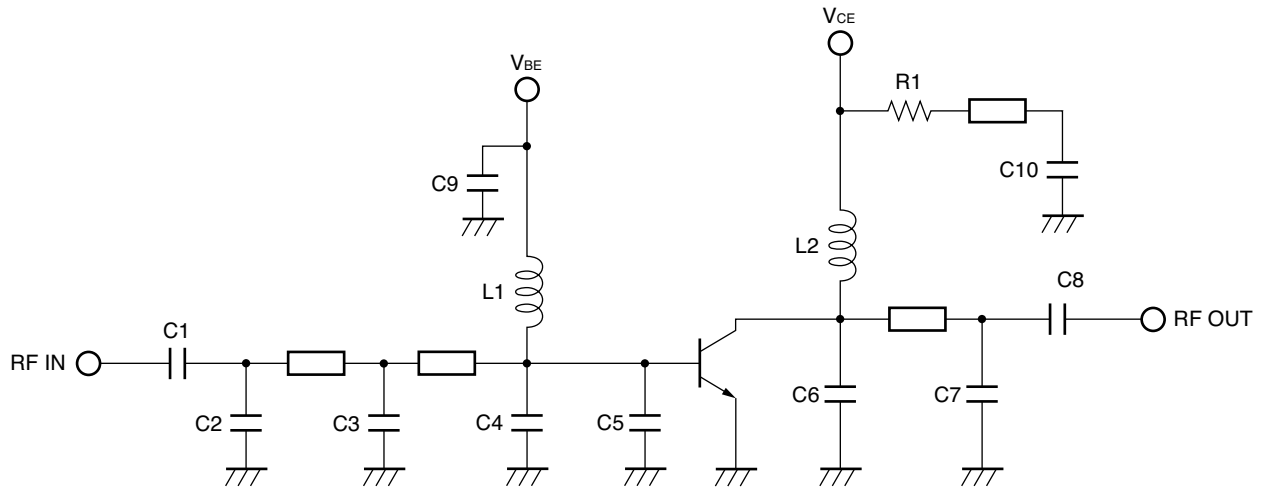

The application circuits and their parameters are for reference only and are not intended for use in actual design-ins.

COMPONENT LIST

	VALUE	MAKER
C1	30 pF	Murata
C2	6 pF	Murata
C3, C4	7 pF	Murata
C5	3 pF	Murata
C6	0.5 pF	Murata
C7	5 pF	Murata
C8	10 pF	Murata
C9, C10	100 nF	Murata
L1	100 nH	Toko
L2	3 nH	Toko
R1	30 Ω	SSM

PA EVALUATION CIRCUIT TYPICAL CHARACTERISTICS

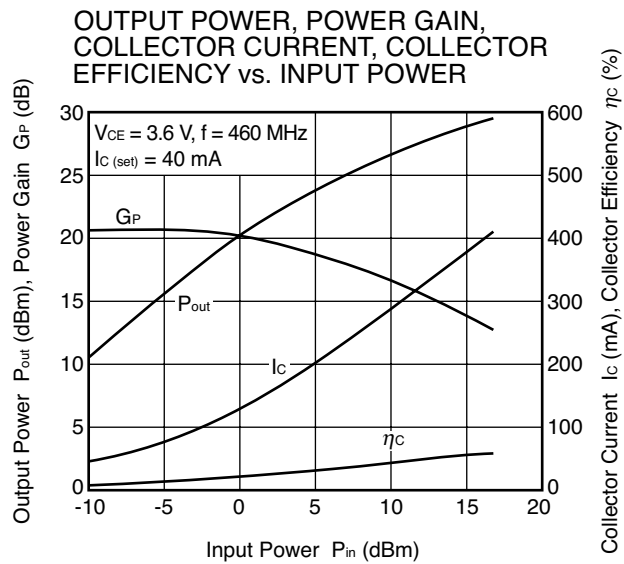

Remark The graphs indicate nominal characteristics.

DISTORTION EVALUATION BOARD (f = 460 MHz)

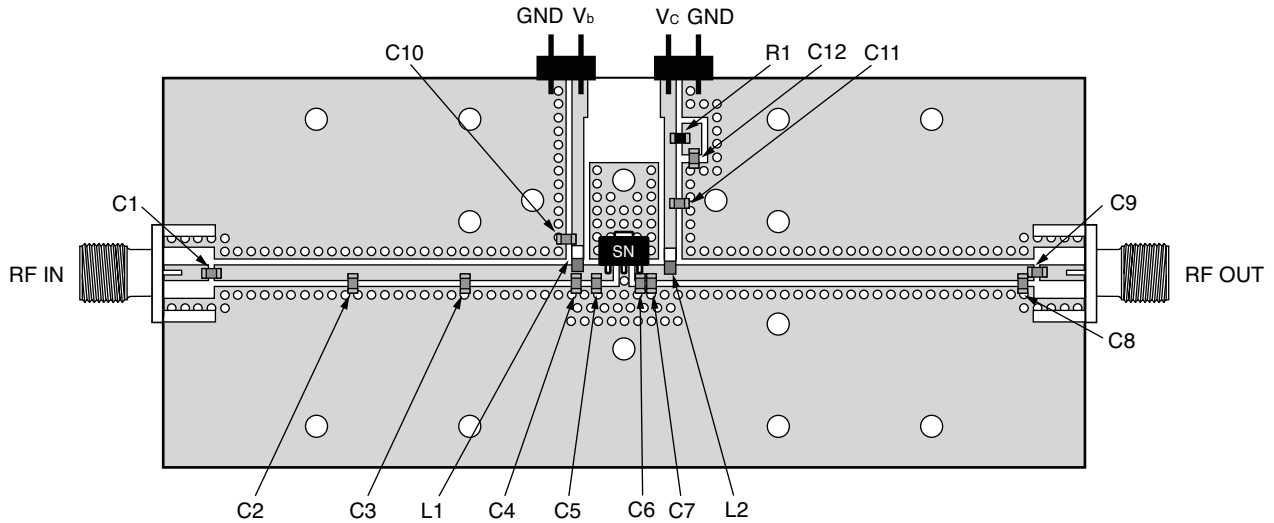

Notes

1. 38 × 90 mm, t = 0.8 mm, double sided copper clad glass epoxy PWB.
2. Back side: GND pattern
3. Solder gold plated on pattern
4. ○: Through holes

DISTORTION EVALUATION CIRCUIT (f = 460 MHz)

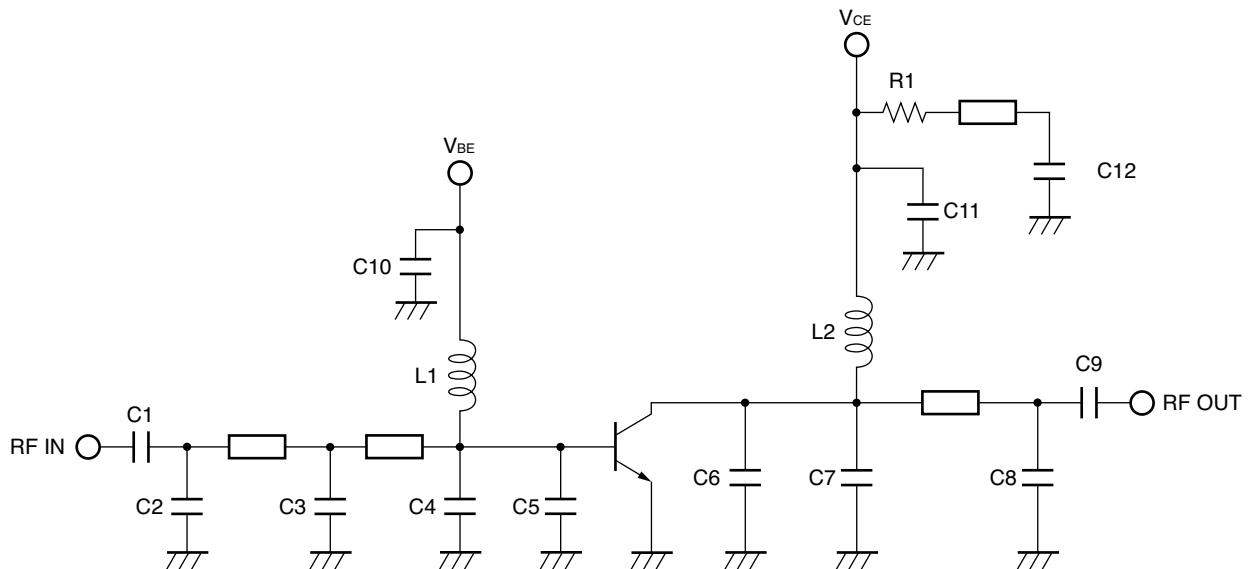

The application circuits and their parameters are for reference only and are not intended for use in actual design-ins.

COMPONENT LIST

	VALUE	MAKER
C1	47 pF	Murata
C2	12 pF	Murata
C3, C4	7 pF	Murata
C5	3 pF	Murata
C6	6 pF	Murata
C7	0.5 pF	Murata
C8	5 pF	Murata
C9	51 pF	Murata
C10, C12	100 nF	Murata
C11	1 μ F	Murata
L1	100 nH	Toko
L2	15 nH	Toko
R1	30 Ω	SSM

DISTORTION EVALUATION CIRCUIT TYPICAL CHARACTERISTICS

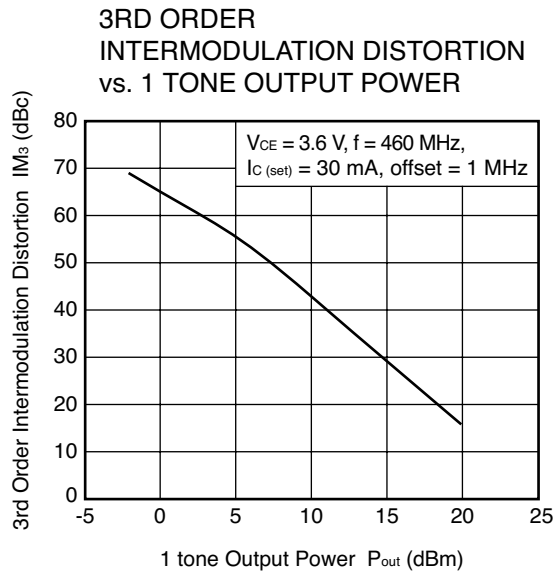

Remark The graphs indicate nominal characteristics.

3-PIN POWER MINIMOLD (34 PACKAGE) (UNIT:mm)

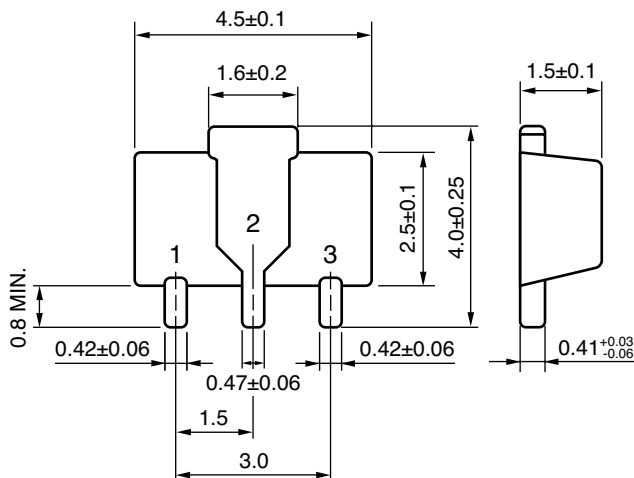

PIN CONNECTIONS

- 1. Collector
- 2. Emitter
- 3. Base

Life Support Applications

These NEC products are not intended for use in life support devices, appliances, or systems where the malfunction of these products can reasonably be expected to result in personal injury. The customers of CEL using or selling these products for use in such applications do so at their own risk and agree to fully indemnify CEL for all damages resulting from such improper use or sale.

CEL California Eastern Laboratories, Your source for NEC RF, Microwave, Optoelectronic, and Fiber Optic Semiconductor Devices.
 4590 Patrick Henry Drive • Santa Clara, CA 95054-1817 • (408) 988-3500 • FAX (408) 988-0279 • www.cel.com

DATA SUBJECT TO CHANGE WITHOUT NOTICE

03/07/2005

Subject: Compliance with EU Directives

CEL certifies, to its knowledge, that semiconductor and laser products detailed below are compliant with the requirements of European Union (EU) Directive 2002/95/EC Restriction on Use of Hazardous Substances in electrical and electronic equipment (RoHS) and the requirements of EU Directive 2003/11/EC Restriction on Penta and Octa BDE.

CEL Pb-free products have the same base part number with a suffix added. The suffix –A indicates that the device is Pb-free. The –AZ suffix is used to designate devices containing Pb which are exempted from the requirement of RoHS directive (*). In all cases the devices have Pb-free terminals. All devices with these suffixes meet the requirements of the RoHS directive.

This status is based on CEL’s understanding of the EU Directives and knowledge of the materials that go into its products as of the date of disclosure of this information.

Restricted Substance per RoHS	Concentration Limit per RoHS (values are not yet fixed)	Concentration contained in CEL devices	
		-A	-AZ
Lead (Pb)	< 1000 PPM	Not Detected	(*)
Mercury	< 1000 PPM	Not Detected	
Cadmium	< 100 PPM	Not Detected	
Hexavalent Chromium	< 1000 PPM	Not Detected	
PBB	< 1000 PPM	Not Detected	
PBDE	< 1000 PPM	Not Detected	

If you should have any additional questions regarding our devices and compliance to environmental standards, please do not hesitate to contact your local representative.

Important Information and Disclaimer: Information provided by CEL on its website or in other communications concerning the substance content of its products represents knowledge and belief as of the date that it is provided. CEL bases its knowledge and belief on information provided by third parties and makes no representation or warranty as to the accuracy of such information. Efforts are underway to better integrate information from third parties. CEL has taken and continues to take reasonable steps to provide representative and accurate information but may not have conducted destructive testing or chemical analysis on incoming materials and chemicals. CEL and CEL suppliers consider certain information to be proprietary, and thus CAS numbers and other limited information may not be available for release.

In no event shall CEL’s liability arising out of such information exceed the total purchase price of the CEL part(s) at issue sold by CEL to customer on an annual basis.

See CEL Terms and Conditions for additional clarification of warranties and liability.