

GT Series Sealed Ultraminiature Toggle Switches

Features/Benefits

- Sealed against solder and cleaning process contaminants
- Ultraminiature size, smallest footprint available
- Thru-hole and surface mount models
- High temperature materials (UL 94V-0)
- RoHS compliant and compatible

Typical Applications

- Hand-held telecommunications
- Small instrumentation



Specifications

CONTACT RATING: 0.4 VA max. @ 20 V AC or DC max.
 MECHANICAL & ELECTRICAL LIFE: 40,000 make-and-break cycles at full load.
 CONTACT RESISTANCE: Below 50 m Ω typ. initial @ 2-4 V DC, 100 mA.
 INSULATION RESISTANCE: 10⁹ Ω min.
 DIELECTRIC STRENGTH: 500 Vrms min. @ sea level.
 OPERATING TEMPERATURE: -30°C to 85°C.
 SOLDERABILITY: Per MIL-STD-202F method 208D, or EIA RS-186E method 9 (1 hour steam aging).
 PACKAGING: Surface mount switches shipped in anti-static tape and reel packaging per EIA 481-3, see page F-47 for drawings and reel information. Tape and cover strip are conductive for use near statically sensitive components, consult Customer Service Center.

Materials

HOUSING AND BASE: Glass filled nylon 4/6, flame retardant, heat stabilized (UL 94V-0).
 ACTUATOR: Glass filled nylon 4/6, flame retardant, heat stabilized (UL 94V-0), with standard internal o-ring seal.
 SWITCH SUPPORT: Brass, tin plated.
 MOVABLE CONTACTS: Copper alloy, with gold plate over nickel plate.
 STATIONARY CONTACTS: Copper alloy, with gold plate over nickel plate.
 TERMINALS: Gold.
 TERMINAL SEAL: Epoxy. All terminals insert molded.

NOTE: Specifications and materials listed above are for switches with standard options. For information on specific and custom switches, consult Customer Service Center.

How To Order

Complete part numbers for GT Series Sealed Ultraminiature Toggle Switches are shown on pages F-43 thru F-47.



GT11MCXE
SPDT

PART NUMBER	SWITCH FUNCTION		
	POS. 1	POS. 2	POS. 3
GT11MCXE GT13MCXE	ON	NONE	ON
Conn. Terms.	2-3	OPEN	2-1
Schematic			
SPDT	Note: Pins 4 and 6 not connected		
GT12MCXE	OFF	NONE	ON
Conn. Terms.	OPEN	N/A	3-1
Schematic			
SPST	Note: Pins 4 and 6 not connected		

NOTE: X= Plating Option; K (tin lead) or B (gold)

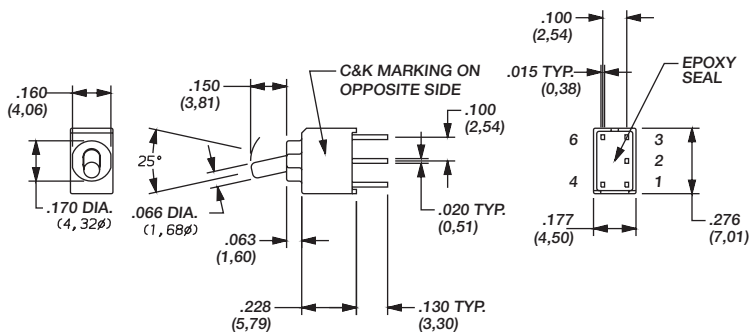

ACTUATOR SHOWN IN POS. 1

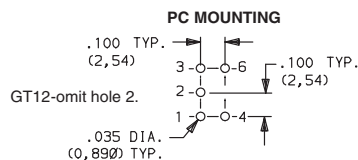

TERMINAL NOS. FOR
REFERENCE ONLY



Dimensions are shown: Inches (mm)
Specifications and dimensions subject to change



GT Series Sealed Ultraminiature Toggle Switches

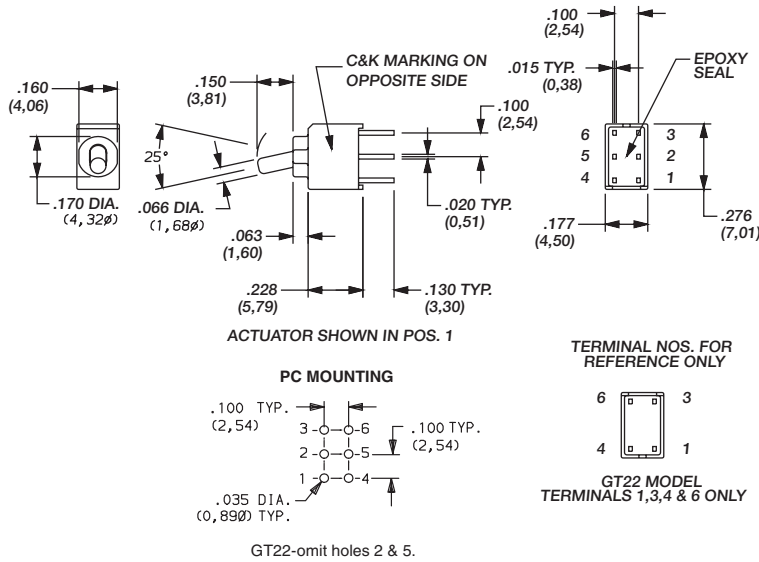

PART NUMBER	SWITCH FUNCTION		
	POS.1	POS. 2	POS. 3
GT21MCXE	ON	NONE	ON
GT23MCXE	ON	OFF	ON
Conn. Terms.	2-3, 5-6	OPEN	2-1, 5-4
Schematic			
DPDT			
GT22MCXE	OFF	NONE	ON
Conn. Terms.	OPEN	N/A	3-1
Schematic			
DPST			



**GT21MCXE
DPDT**

NOTE: X= Plating Option; K (tin lead) or B (gold)

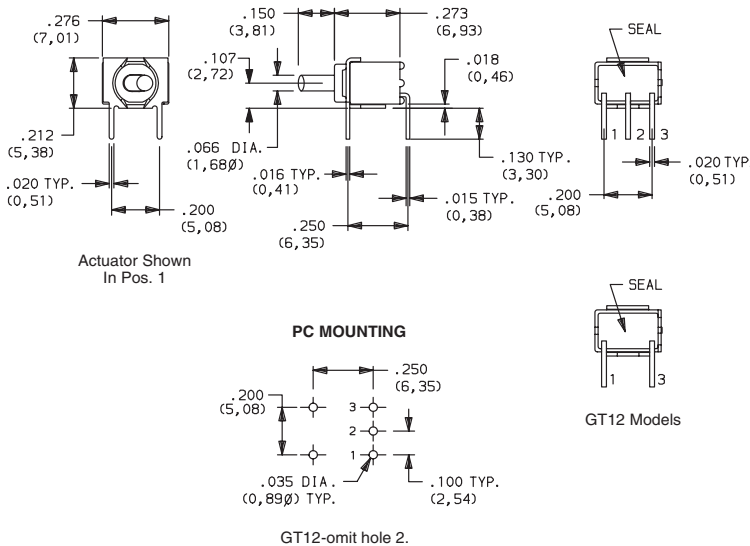

PART NUMBER	SWITCH FUNCTION		
	POS.1	POS. 2	POS. 3
GT11MABE	ON	NONE	ON
GT13MABE	ON	OFF	ON
Conn. Terms.	2-3	OPEN	2-1
Schematic			
SPDT			
GT12MABE	OFF	NONE	ON
Conn. Terms.	OPEN	N/A	3-1
Schematic			
SPST			



**GT11MABE
Horizontal Actuation
SPDT**

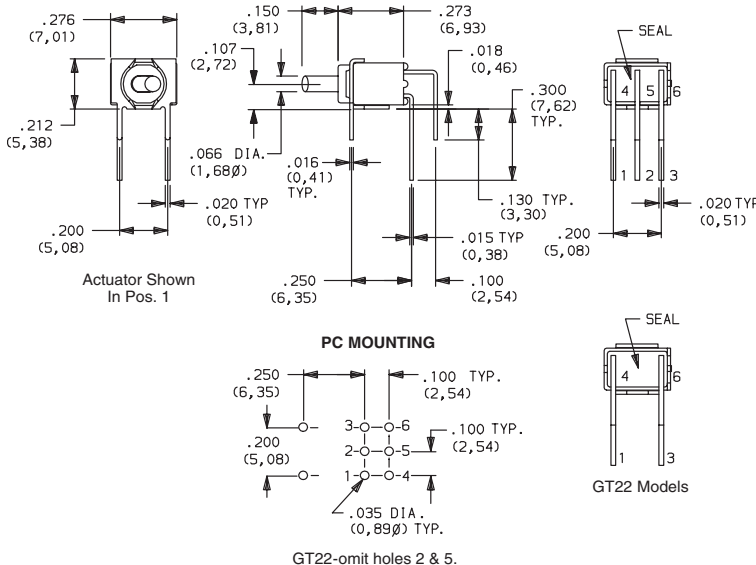

PART NUMBER	SWITCH FUNCTION		
	POS.1	POS. 2	POS. 3
GT21MABE	ON	NONE	ON
GT23MABE	ON	OFF	ON
Conn. Terms.	2-3, 5-6	OPEN	2-1, 5-4
Schematic			
DPDT			
GT22MABE	OFF	NONE	ON
Conn. Terms.	OPEN	N/A	3-1, 6-4
Schematic			
DPST			



**GT21MABE
Horizontal Actuation
DPDT**



Dimensions are shown: Inches (mm)
Specifications and dimensions subject to change

GT Series Sealed Ultraminiature Toggle Switches



GT11MAVBE
Vertical
Actuation
SPDT

PART NUMBER	SWITCH FUNCTION		
	POS.1	POS. 2	POS. 3
GT11MAVBE	ON	NONE	ON
GT13MAVBE	ON	OFF	ON
Conn. Terms.	2-3	OPEN	2-1
Schematic			
SPDT			
GT12MAVBE	OFF	NONE	ON
Conn. Terms.	OPEN	N/A	3-1
Schematic			
SPST			

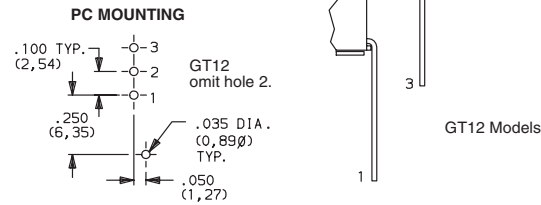
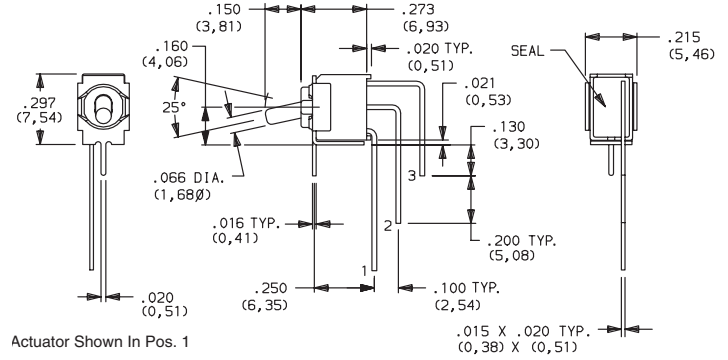

GT21MAVBE
Vertical
Actuation
DPDT

PART NUMBER	SWITCH FUNCTION		
	POS.1	POS. 2	POS. 3
GT21MAVBE	ON	NONE	ON
GT23MAVBE	ON	OFF	ON
Conn. Terms.	2-3, 5-6	OPEN	2-1, 5-4
Schematic			
DPDT			
GT22MAVBE	OFF	NONE	ON
Conn. Terms.	OPEN	N/A	3-1, 6-4
Schematic			
DPST			

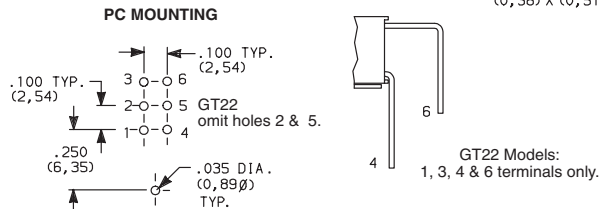
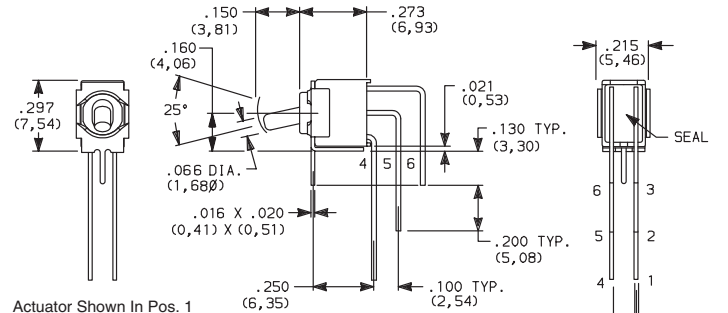

GT11MV3XE
SPDT

PART NUMBER	SWITCH FUNCTION		
	POS.1	POS. 2	POS. 3
GT11MV3XE	ON	NONE	ON
GT13MV3XE	ON	OFF	ON
Conn. Terms.	2-3	OPEN	2-1
Schematic			
SPDT	Note: Pins 4 and 6 not connected		
GT12MV3XE	OFF	NONE	ON
Conn. Terms.	OPEN	N/A	3-1
Schematic			
SPST	Note: Pins 4 and 6 not connected		

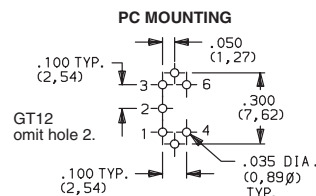
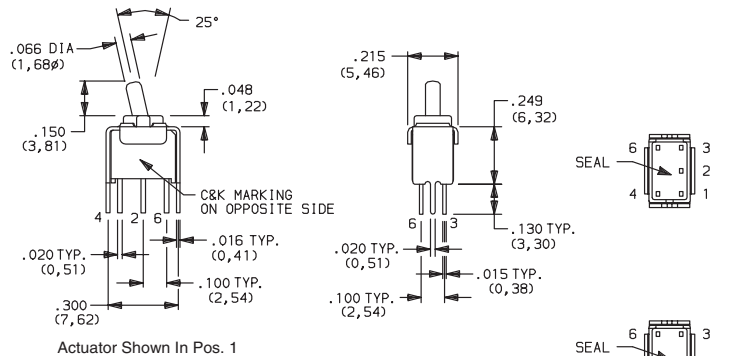

NOTE: X= Plating Option; K (tin lead) or B (gold)



Dimensions are shown: Inches (mm)
Specifications and dimensions subject to change



GT Series Sealed Ultraminiature Toggle Switches



GT21MV3XE
DPDT

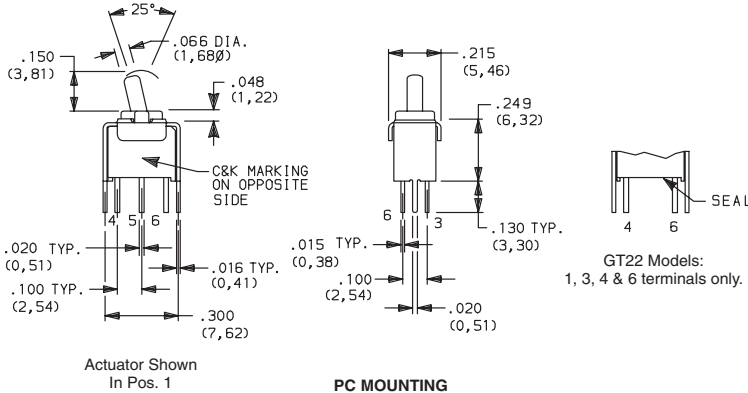

PC MOUNTING

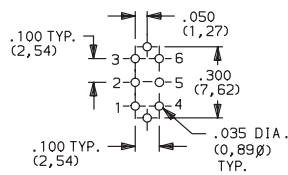

PART NUMBER	SWITCH FUNCTION		
	POS.1	POS. 2	POS. 3
GT21MV3XE GT23MV3XE	ON	NONE	ON
Conn. Terms.	2-3, 5-6	OPEN	2-1, 5-4
Schematic			
DPDT			
GT22MV3XE	OFF	NONE	ON
Conn. Terms.	OPEN	N/A	3-1, 6-4
Schematic			
DPST			

NOTE: X= Plating Option; K (tin lead) or B (gold)



GT11MSABE
Horizontal
Actuation
SPDT

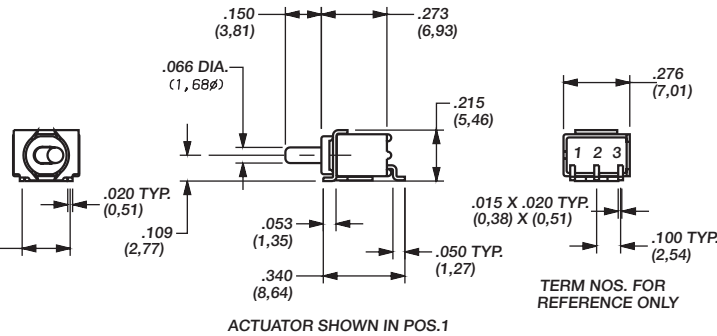

PC MOUNTING

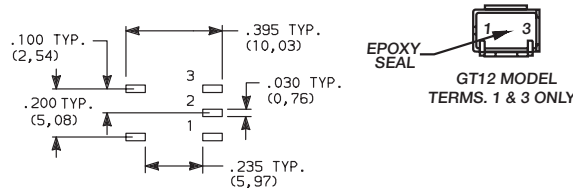

PART NUMBER	SWITCH FUNCTION		
	POS.1	POS. 2	POS. 3
GT11MSABETR GT13MSABETR	ON	NONE	ON
Conn. Terms.	2-3	OPEN	2-1
Schematic			
SPDT			
GT12MSABETR	OFF	NONE	ON
Conn. Terms.	OPEN	N/A	3-1
Schematic			
SPST			

Standard with tape & reel packaging, see page F-47.

GT12-omit pad 2.



GT11MSCXE
SPDT

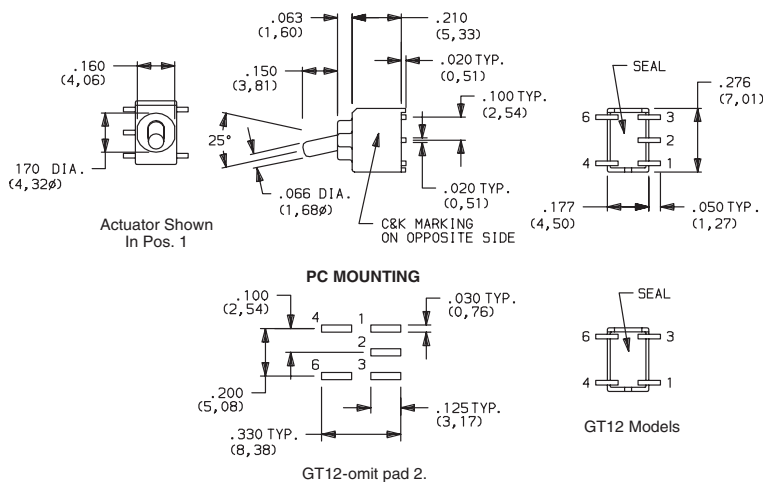

GT12-omit pad 2.

PART NUMBER	SWITCH FUNCTION		
	POS.1	POS. 2	POS. 3
GT11MSCXETR GT13MSCXETR	ON	NONE	ON
Conn. Terms.	2-3	OPEN	2-1
Schematic			
SPDT			
GT12MSCXETR	OFF	NONE	ON
Conn. Terms.	OPEN	N/A	3-1
Schematic			
SPST			

NOTE: X= Plating Option; K (tin lead) or B (gold)



Dimensions are shown: Inches (mm)
Specifications and dimensions subject to change

www.ck-components.com

GT Series Sealed Ultraminiature Toggle Switches



GT21MSCXE
DPDT

PART NUMBER	SWITCH FUNCTION		
	POS. 1	POS. 2	POS. 3
GT21MSCXETR	ON	NONE	ON
GT23MSCXETR	ON	OFF	ON
Conn. Terms.	2-3, 5-6	OPEN	2-1, 5-4
Schematic			
DPDT			
GT22MSCXETR	OFF	NONE	ON
Conn. Terms.	OPEN	N/A	3-1, 6-4
Schematic			
DPST			

NOTE: X= Plating Option; K (tin lead) or B (gold)

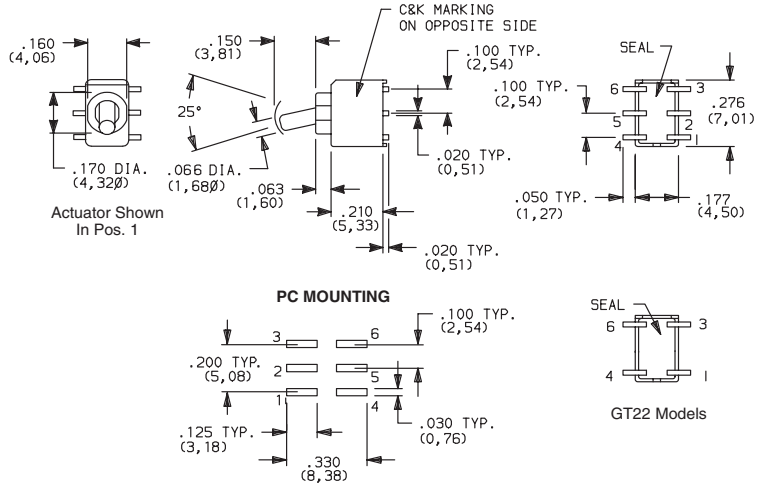

GT22-omit pads 2 & 5.

Standard with tape & reel packaging

TAPE & REEL

For part numbers GT11MSABE, GT12MSABE, GT13MSABE

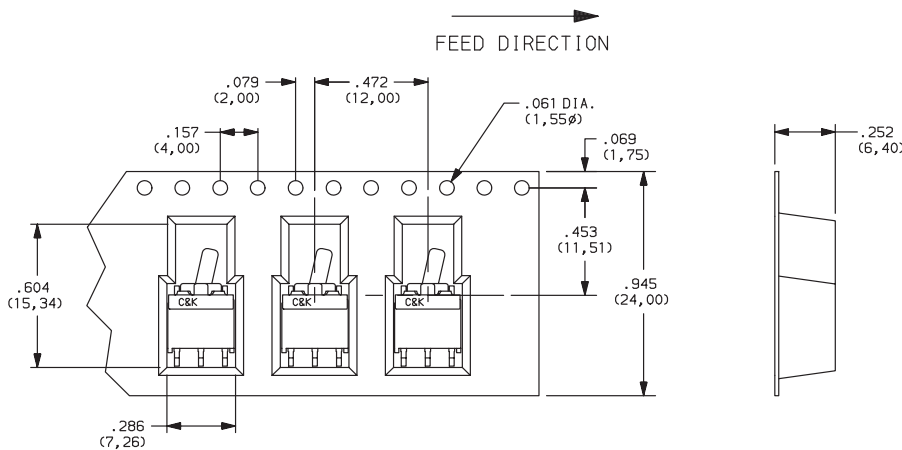

REEL INFORMATION	
OUTSIDE DIAMETER	13.00 (330,0)
PILOT HOLE	.512 (13,0)
QUANTITY PER REEL	600

For part numbers GT11MSCBE, GT12MSCBE, GT13MSCBE, GT21MSCBE, GT22MSCBE, GT23MSCBE,

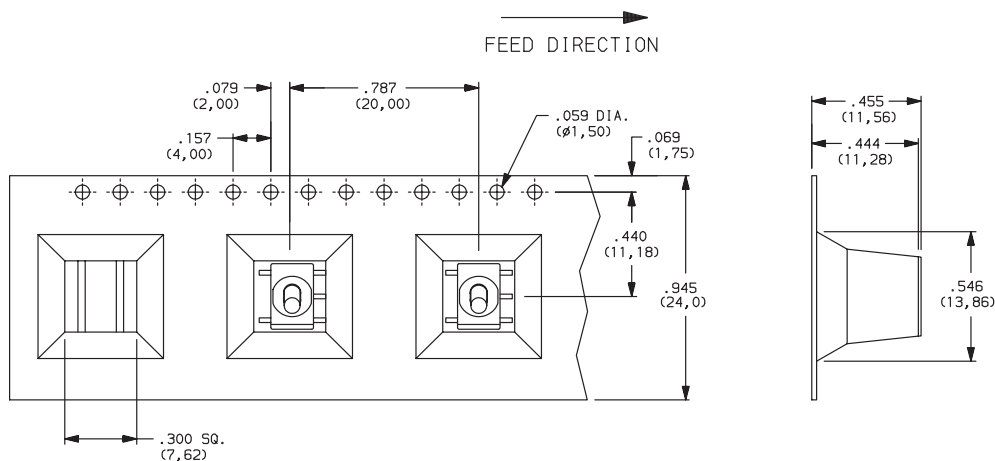

REEL INFORMATION	
OUTSIDE DIAMETER	13.00 (330,0)
PILOT HOLE	.512 (13,0)
QUANTITY PER REEL	200



Third Angle
Projection
Dimensions are shown: Inches (mm)
Specifications and dimensions subject to change

