





A

Pushbutton

## European Order Code - Switch Only

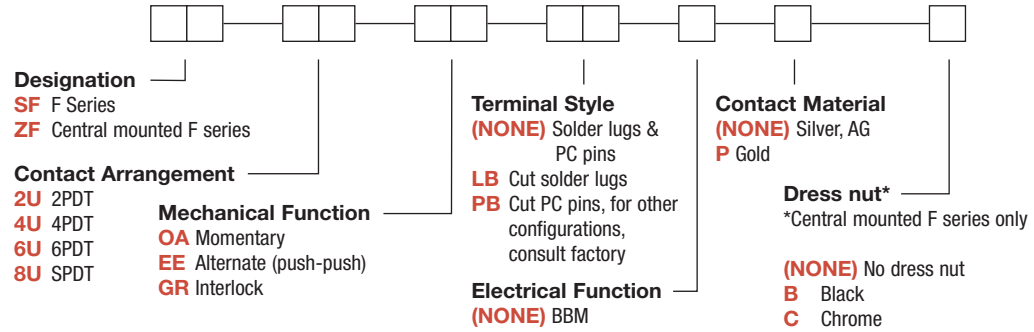

\*Minimum order quantities apply.

## Order Code - Buttons

### Solid Buttons



### Mechanical Indicator Buttons



\*Button options for central mounting configurations, use 'FG' for central mount with chrome dress nut, use 'FA200' for central mount with black dress nut.

## BUTTON REMOVAL

A button of a push-push switch should only be removed in the "OFF" non-latching position.





# F Series Pushbutton Switches

Pushbutton  
A

## Order Code - Chassis

To order a switch with chassis, create the switch part number listed above and add the Chassis part number configurator information at the end of the part number.

Note: We do not guarantee or recommend interlocking beyond 10 stations.

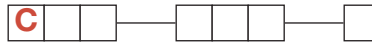

**No. of Stations**  
**01 thru 23** Comes with standard .094 (2,4mm) mounting holes  
Note: Single station chassis available with special mounting configurations, consult factory.

**Spacing between Stations**  
**00** Single station  
**10** 10mm  
**12.5** 12.5mm  
**15** 15mm  
**17.5** 17.5mm  
**20** 20mm

**Special Acknowledgements**  
See note

\*Minimum order quantities apply.

## SWITCHES WITH STANDARD OPTIONS

### F2UEE

CONTACT ARRANGEMENT	LENGTH DIM 'L'
2U	0.827 (21,00)
4U	1.300 (33,00)
6U	1.770 (45,00)
8U	2.240 (57,00)
10U	2.720 (69,00)

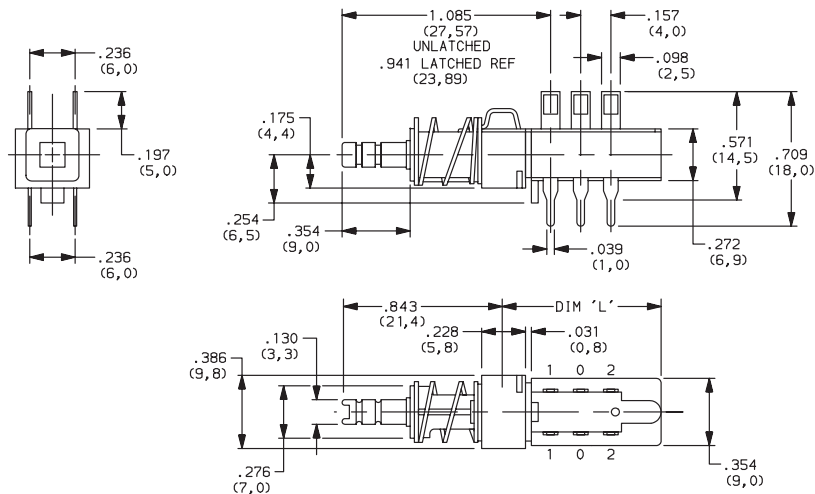

### ZF2UEEBF11010108

CONTACT ARRANGEMENT	LENGTH DIM 'L'
2U	0.827 (21,00)
4U	1.300 (33,00)
6U	1.770 (45,00)
8U	2.240 (57,00)
10U	2.720 (69,00)

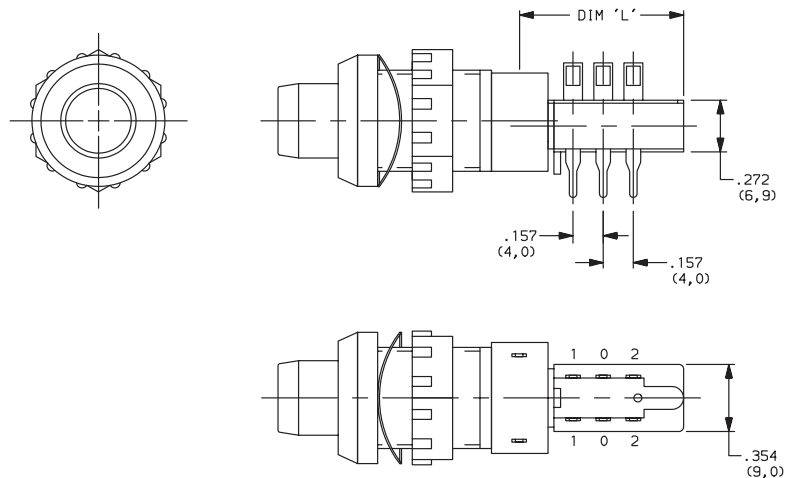

Dimensions are shown: Inches (mm)  
Specifications and dimensions subject to change



# F Series Pushbutton Switches



A

Pushbutton

## DESIGNATION



### Designation, North America

- F** F Series
- FLT** Light touch F series
- ZF** Central mounted F series

### Designation, Europe

- SF** F Series
- ZF** Central mounted F series

## CONTACT ARRANGEMENT



OPTION CODE	NO. OF POLES	SCHEMATIC
<b>2U</b>	2PDT	
<b>4U</b>	4PDT	2X
<b>6U</b>	6PDT	3X
<b>8U</b>	8PDT	4X
<b>10U</b>	10PDT	5X

### PC MOUNTING

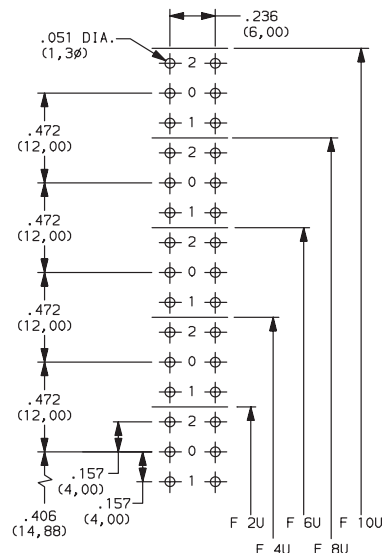

## MECHANICAL FUNCTION



### North America

OPTION CODE	FUNCTION
<b>OA</b>	Momentary
<b>EE</b>	Alternate (push-push)
<b>GR</b>	Interlock
<b>AOR</b>	Central release
<b>OASP</b>	Momentary with lockout
<b>GRSP</b>	Interlock with lockout

### Europe

OPTION CODE	FUNCTION
<b>OA</b>	Momentary
<b>EE</b>	Alternate (push-push)
<b>GR</b>	Interlock

## TERMINAL SEALING



**(NONE)** NO SEAL

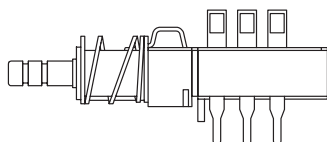

F2UEE shown in example above.

**TB** TOP & BOTTOM

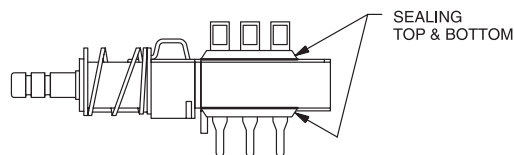

**NOTE:** Available for North America only

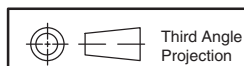

Dimensions are shown: Inches (mm)  
Specifications and dimensions subject to change





# F Series Pushbutton Switches

Pushbutton  
A

## TERMINAL STYLE



**(NONE)** SOLDER LUGS & PC PINS



**01A** CUT SOLDER LUGS (North America)  
**LB** CUT SOLDER LUGS (Europe)

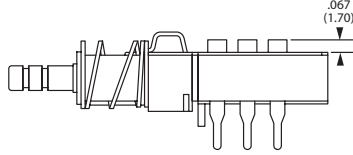

**01B** CUT PC PINS (North America)  
**PB** CUT PC PINS (Europe)

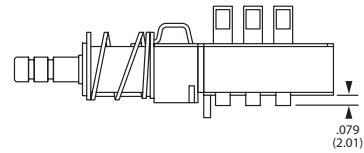

## ELECTRICAL FUNCTION



OPTION CODE	FUNCTION
<b>(NONE)</b>	BBM Non-shorting
<b>M</b>	MBB Shorting (North America only)

## CONTACT MATERIAL



NORTH AMERICA OPTION CODE	EUROPE OPTION CODE	RoHS COMPLIANT *	RoHS COMPATIBLE *	MATERIAL	RATING
<b>(NONE)</b>	<b>(NONE)</b>	YES	YES	SILVER, AG	50 VA/15 W; 125/30 V; 0.5/0.5 A
<b>AU</b>	<b>P</b>	YES	YES	GOLD	1 VA/300mW; 50/30 V; 0.04 A/0.01 A

\* Note: See Technical Data section of this catalog for RoHS compliant and compatible definitions and specifications.

## DRESS NUT



**(NONE)** NO DRESS NUT FOR F & F/LT DESIGNATIONS

**B** BLACK

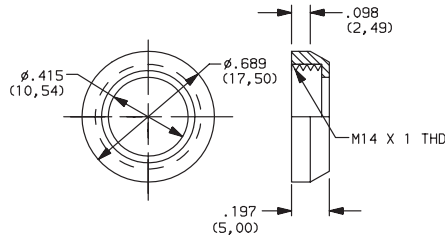

### PANEL CUTOUT

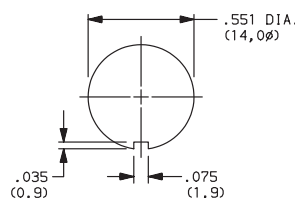

NOTE: Available with ZF designation and FA200 buttons.

**C** CHROME

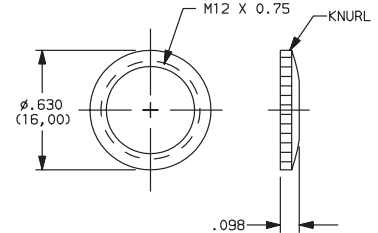

### PANEL CUTOUT

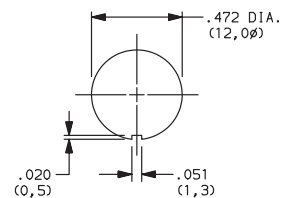

NOTE: Available with ZF designation and FG button.

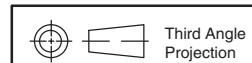

Dimensions are shown: Inches (mm)  
Specifications and dimensions subject to change



# F Series Pushbutton Switches



A  
Pushbutton

## SOLID BUTTON



### STYLE

**F01** FMR

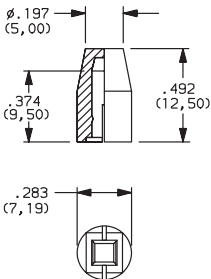

**F02** FG

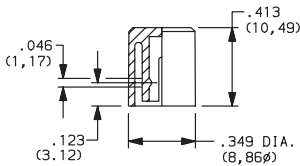

**F12** FSC

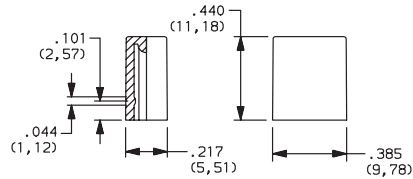
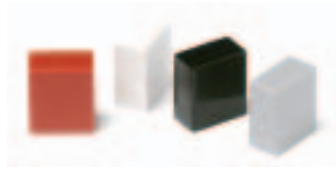

**F13** FSD

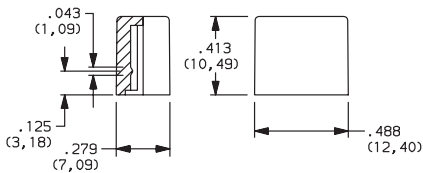
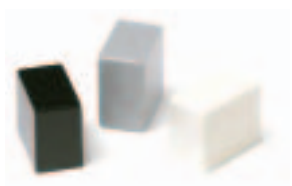

**F14** FU12

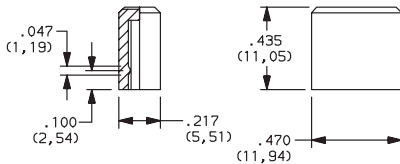

OPTION CODE	COLOR
01	BLACK
02	WHITE
03	RED
04	LT. GRAY



Dimensions are shown: Inches (mm)  
Specifications and dimensions subject to change



# F Series Pushbutton Switches

A  
Pushbutton

**SOLID BUTTON**

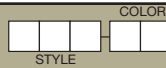

## STYLE

**F15** FSB

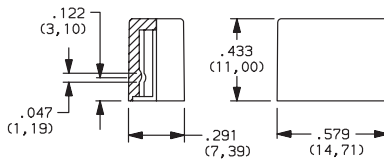

**F16** FE

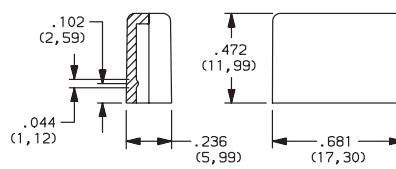

**F19** FA

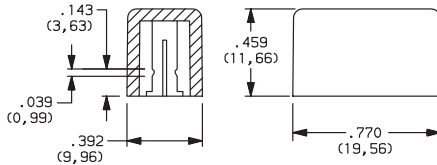

**F21** F001

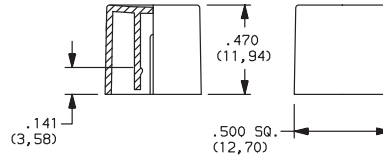

OPTION CODE	COLOR
<b>01</b>	BLACK
<b>02</b>	WHITE
<b>03</b>	RED
<b>04</b>	LT. GRAY

## MECHANICAL BUTTON

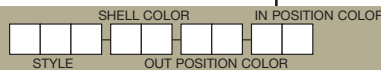

## STYLE

**F01** FA100

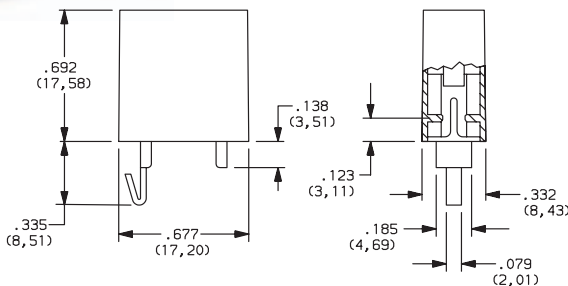

**F02** FA101

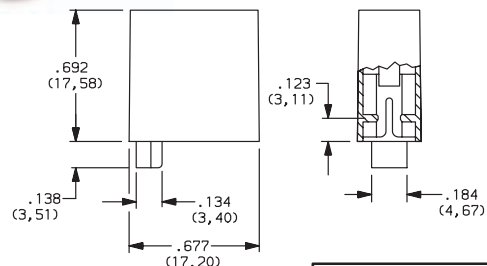

Dimensions are shown: Inches (mm)  
Specifications and dimensions subject to change



# F Series Pushbutton Switches



A

Pushbutton

## MECHANICAL BUTTON

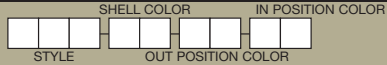

### STYLE

**F07** FA120

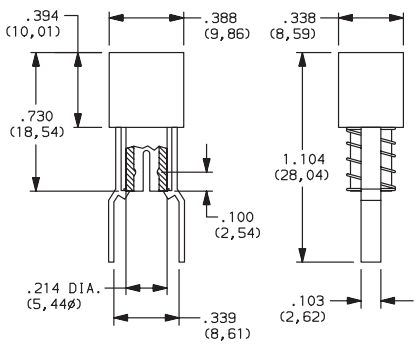

**F08** FA201

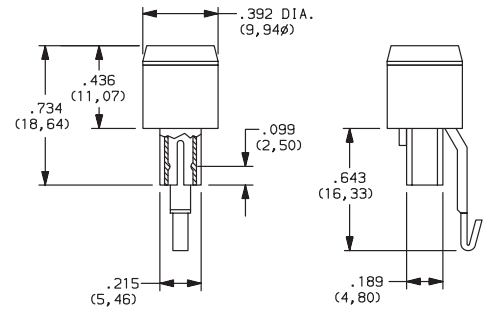

**F11** FA200

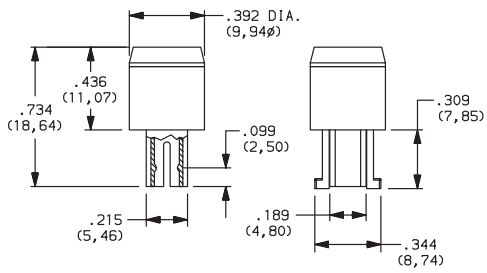
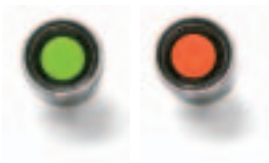

### SHELL COLOR

**01** BLACK

### OUT POSITION COLOR

**01** BLACK

### IN POSITION COLOR

OPTION CODE	COLOR
<b>02</b>	WHITE
<b>06</b>	YELLOW
<b>07</b>	BLUE
<b>08</b>	GREEN
<b>12</b>	ORANGE

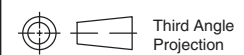

Dimensions are shown: Inches (mm)  
 Specifications and dimensions subject to change





# F Series Pushbutton Switches

A  
Pushbutton

CHASSIS

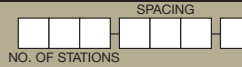

## NUMBER OF STATIONS

**C00 Thru C10** Comes with standard 0.094 (2,44mm) mounting holes

**NOTE:** Single station chassis available with mounting configurations, consult factory.

## SPACING

**00** SINGLE STATION

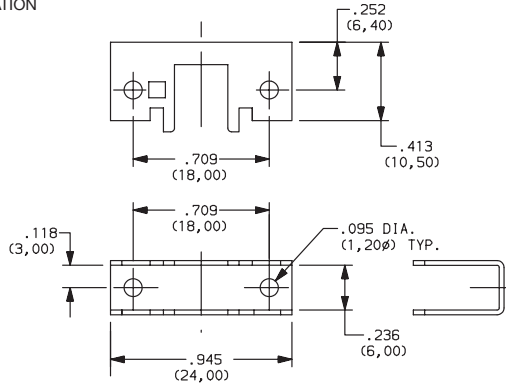

**10** 10mm

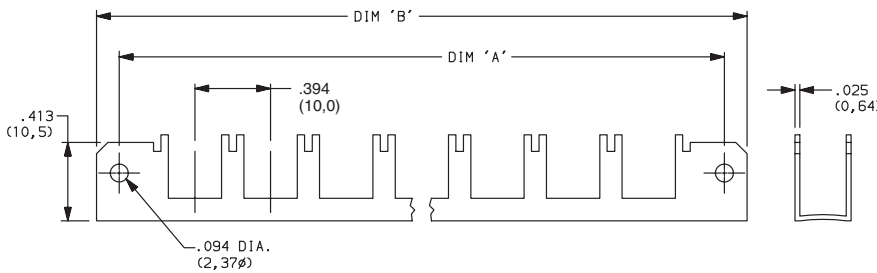

No. of Stations	Dim. 'A'	Dim. 'B'	Tolerance
2	1.182 (30,02)	1.418 (36,02)	0.005
3	1.575 (40,01)	1.811 (46,00)	0.010
4	1.969 (50,01)	2.205 (56,01)	0.010
5	2.363 (60,02)	2.599 (66,01)	0.010
6	2.757 (70,03)	2.993 (76,02)	0.015
7	3.150 (80,01)	3.386 (86,00)	0.015
8	3.544 (90,02)	3.780 (96,01)	0.015
9	3.938 (100,03)	4.174 (106,02)	0.015
10	4.331 (110,01)	4.567 (116,00)	0.015

**12.5** 12.5mm

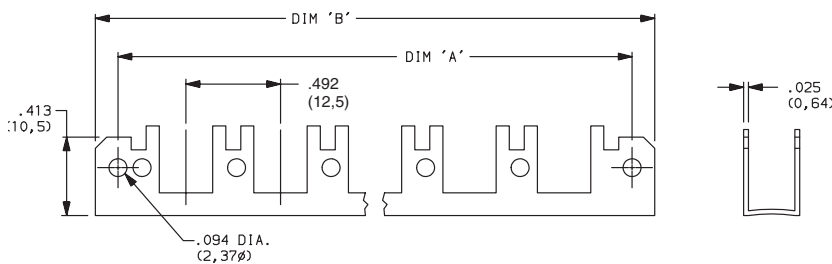

No. of Stations	Dim. 'A'	Dim. 'B'	Tolerance
2	1.200 (30,48)	1.436 (36,47)	0.005
3	1.692 (42,98)	1.928 (48,97)	0.010
4	2.184 (55,47)	2.420 (61,47)	0.010
5	2.676 (67,97)	2.912 (73,96)	0.010
6	3.169 (80,49)	3.405 (86,49)	0.015
7	3.661 (92,99)	3.897 (98,98)	0.015
8	4.153 (105,49)	4.389 (111,48)	0.015
9	4.645 (117,98)	4.881 (123,98)	0.015
10	5.137 (130,48)	5.373 (136,47)	0.015



Third Angle  
Projection

Dimensions are shown: Inches (mm)  
Specifications and dimensions subject to change



# F Series Pushbutton Switches



A

Pushbutton

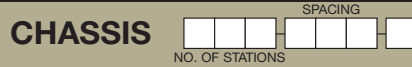

## SPACING

**15** 15mm

No. of Stations	Dim. 'A'	Dim. 'B'	Tolerance
2	1.374 (34,90)	1.615 (41,02)	0.005
3	1.969 (50,01)	2.205 (56,01)	0.010
4	2.560 (65,02)	2.796 (71,02)	0.010
5	3.150 (80,01)	3.386 (86,00)	0.010
6	3.741 (95,02)	3.977 (101,02)	0.015
7	4.332 (110,03)	4.568 (116,03)	0.015
8	4.922 (125,02)	5.158 (131,01)	0.015
9	5.513 (140,03)	5.749 (146,02)	0.015
10	6.103 (155,02)	6.339 (161,01)	0.015

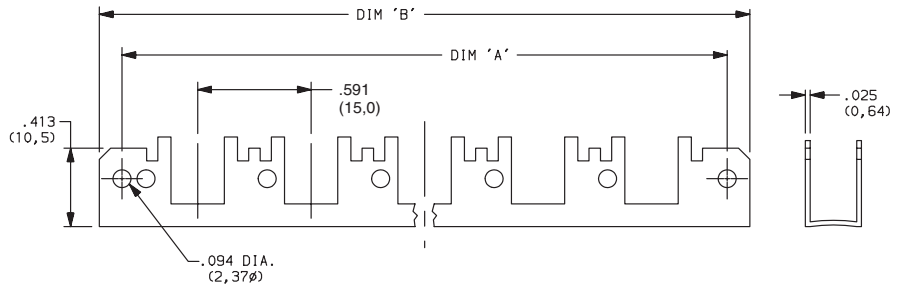

**17.5** 17.5mm

No. of Stations	Dim. 'A'	Dim. 'B'	Tolerance
2	1.477 (37,52)	1.713 (43,51)	0.005
3	2.166 (55,02)	2.402 (61,01)	0.010
4	2.855 (75,52)	3.091 (78,51)	0.010
5	3.544 (90,02)	3.780 (96,01)	0.010
6	4.233 (107,52)	4.469 (113,51)	0.015
7	4.922 (125,02)	5.158 (131,01)	0.015
8	5.611 (142,52)	5.847 (148,51)	0.015
9	6.300 (160,02)	6.536 (166,01)	0.015
10	6.989 (177,52)	7.225 (183,52)	0.015

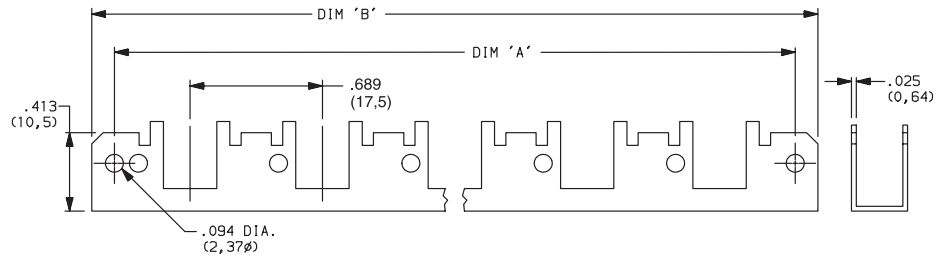

**20** 20mm

No. of Stations	Dim. 'A'	Dim. 'B'	Tolerance
2	1.575 (40,01)	1.811 (46,00)	0.005
3	2.363 (60,02)	2.599 (66,01)	0.010
4	3.150 (80,01)	3.386 (86,00)	0.010
5	3.938 (100,03)	4.174 (106,02)	0.010
6	4.725 (120,02)	4.961 (126,01)	0.015
7	5.512 (140,00)	5.748 (146,00)	0.015
8	6.300 (160,02)	6.536 (166,01)	0.015
9	7.087 (180,01)	7.323 (186,00)	0.015
10	7.875 (200,03)	8.111 (206,02)	0.015

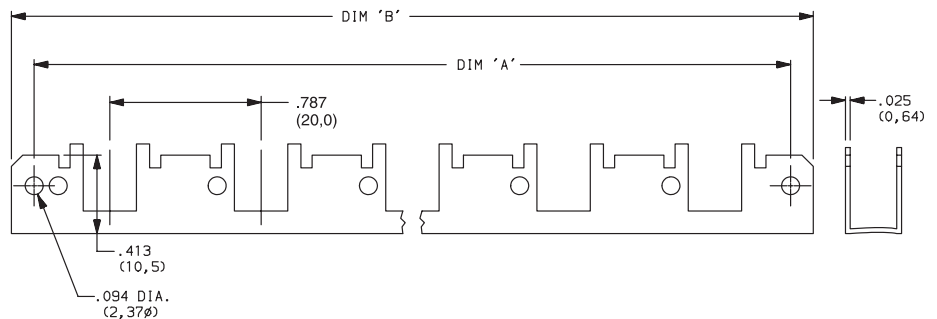

Dimensions are shown: Inches (mm)  
Specifications and dimensions subject to change

