

# ET Series Sealed Subminiature Toggle Switches

## Features/Benefits

- Sealed against solder and cleaning process contaminants
- ESD protection available
- Thru-hole and surface mount models
- Compact size and small footprint save PCB space
- RoHS compliant models available



Models Available

## Typical Applications

- Hand-held telecommunications
- Instrumentation
- Medical equipment



## Specifications

**CONTACT RATING:** B contact material: 0.4 VA max. @ 20 V AC or DC max. See page G-35 for additional ratings.

**ELECTRICAL LIFE:** ETX1 models: 60,000 make-and-break cycles at full load. All other models: 30,000 cycles.

**CONTACT RESISTANCE:** Below 20 m Ω typ. initial @ 2-4 V DC, 100 mA, for both silver and gold plated contacts.

**INSULATION RESISTANCE:** 10<sup>9</sup> Ω min.

**ELECTROSTATIC DISCHARGE (ESD) RESISTANT OPTION:**  
M3 & S3 insulating actuator only: 9,000 V DC min. @ sea level, actuator to terminals. F1 conductive bushing only: Dissipates up to 20,000 V DC from actuator to ground. M3 & S3 actuator and F1 bushing options are not recommended for use together.

**DIELECTRIC STRENGTH:** 1000 Vrms min. @ sea level.

**OPERATING TEMPERATURE:** -30°C to 85°C.

**SOLDERABILITY:** Per MIL-STD-202F method 208D, or EIA RS-186E method 9 (1 hour steam aging).

**DEGREE OF PROTECTION:** IP57; Protection against harmful dust deposit, full-scale voltage protection, temporary immersion.

**PACKAGING:** Surface mount switches are shipped in tape and reel packaging, see page G-36 for drawings and reel information.

## Materials

**CASE & BUSHING:** Glass filled nylon 6/6, flame retardant, heat stabilized (UL 94V-0) or glass filled 4/6 nylon, flame retardant, heat stabilized (UL 94V-0). F1 conductive bushing option is impregnated with carbon fibers.

**ACTUATOR:** M3 & S3 anti-static actuator: Nylon 4/6, black standard (UL 94V-0). All other actuators: Brass, chrome plated. Internal o-ring seal standard with all actuators.

**SWITCH SUPPORT:** Brass, tin plated.

**CONTACTS & TERMINALS:** B contact material: Copper alloy, with gold plate over nickel plate. Q contact material: Copper alloy, silver plated. See G-35 for additional contact materials.

**TERMINAL SEAL:** Epoxy.

**NOTE:** Any models supplied with Q, B, G, P or R contact material are RoHS compliant and compatible.

**NOTE:** Specifications and materials listed above are for switches with standard options. For information on specific and custom switches, consult Customer Service Center.

## Build-A-Switch

To order, simply select desired option from each category and place in the appropriate box. Available options are shown and described on pages G-31 thru G-35. For additional options not shown in catalog, consult our Customer Service Center. All models are process sealed to withstand machine soldering temperatures and pressure wash cleaning methods.

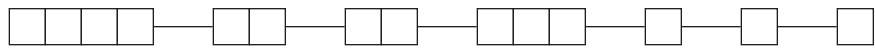

### Switch Function

- ET01** SP, On-None-On
- ET02** SPST, Off-None-On
- ET03** SP, On-Off-On
- ET05** SP, Mom.-Off-Mom.
- ET07** SP, On-Off-Mom.
- ET08** SP, On-None-Mom.
- ET21** DP, On-None-On
- ET23** DP, On-Off-On
- ET24** DP, On-On-On
- ET25** DP, Mom.-Off-Mom.
- ET27** DP, On-Off-Mom.
- ET28** DP, On-None-Mom.

### Actuator

- M** .240" high
- M3** Plastic, anti-static, .240" high
- S** .400" high
- L** .320" high
- S1** .540" high

### Bushing

- D1** .177" High, Unthreaded
- F1** .177" high, unthreaded, ESD conductive

### Terminations

- A** Right angle, PC thru-hole
- AV** Vertical right angle, PC thru-hole
- C** PC Thru-hole
- SA** Right angle, surface mount
- SA1** Right angle, surface mount rear-facing
- V3** Vertical mount, V-bracket
- AV3** Vertical right angle, snap-in, PC thru-hole
- V31** Vertical mount, V-bracket, snap-in
- W** Wire wrap

### Contact Material

- B** Gold
- P** Gold, matte tin
- Q** Silver
- S** Silver/matte-tin
- G** Gold over silver
- R** Gold over silver, matte-tin

### Seal

- E** Epoxy

### Plastic Actuator Color

- NONE** No actuator color
- 2** Black
- 1** White

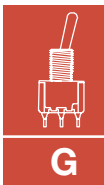

Toggle



Dimensions are shown: Inch (mm)  
Specifications and dimensions subject to change

# ET Series Sealed Subminiature Toggle Switches

## SWITCH FUNCTION

NO. POLES	MODEL NO.	SWITCH FUNCTION			CONNECTED TERMINALS			SCHEMATIC
		POS. 1	POS. 2	POS. 3	POS. 1	POS. 2	POS. 3	
		C&K marking on opposite side			C&K marking on opposite side			
SP	<b>ET01</b>	ON	NONE	ON	2-3	N/A	2-1	
	<b>ET03</b>	ON	OFF	ON	2-3	OPEN	2-1	
	<b>ET05</b>	MOM.	OFF	MOM.				
	<b>ET07</b>	ON	OFF	MOM.				
	<b>ET08</b>	ON	NONE	MOM.				
	<b>ET02</b>	OFF	NONE	ON	OPEN	N/A	3-1	
<b>SPDT</b> <p style="text-align: center;">Part number shown: ET01MD1CBE      ET02 Models: Omit terminal 2</p>								
DP	<b>ET21</b>	ON	NONE	ON	2-3,5-6	N/A	2-1,5-4	
	<b>ET23</b>	ON	OFF	ON	2-3,5-6	OPEN	2-1,5-4	
	<b>ET25</b>	MOM.	OFF	MOM.				
	<b>ET27</b>	ON	OFF	MOM.				
	<b>ET28</b>	ON	NONE	MOM.				
	<b>ET24**</b>	ON	ON	ON	2-3,5-6	2-3,5-4	2-1,5-4	
<b>DPDT</b> <p style="text-align: center;">Part number shown: ET21MD1CBE</p>								

MOM. = Momentary

\*\* Wiring for 3-way switch, see Section O.

All models with all options (except M3 actuator) when ordered with G, L, R or Q contact material except with F1 conductive bushing.

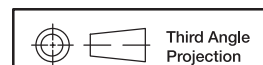

Dimensions are shown: Inch (mm)

Specifications and dimensions subject to change

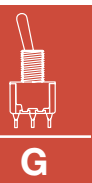

G

Toggle

# ET Series Sealed Subminiature Toggle Switches

## ACTUATOR

ACTUATOR COLOR

**M** .240" HIGH

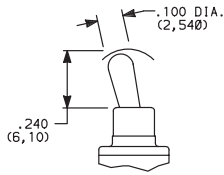

Standard with A, AV, V3 & V31 terminations.

**M3** PLASTIC, ANTISTATIC, .240" HIGH

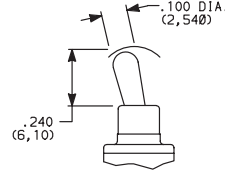

Material: Nylon 4/6 (UL 94V-0), black standard. Static resistance: 9,000 V DC min. @ sea level, actuator to terminals. Not available with F1 conductive bushing option. Not UL approved.

**S** .400" HIGH

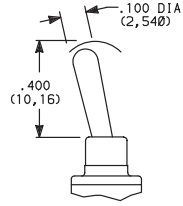

Standard with C or W terminations.

**L** .320" HIGH

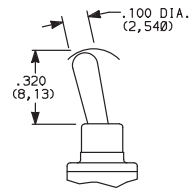

**S1** .540" HIGH

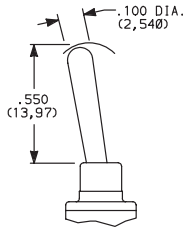

OPTION CODE	PLASTIC ACTUATOR COLOR
(NONE)	BLACK (M3 & S3 only)
1	WHITE (M3 & S3 only)

**NOTE:** All actuators have chrome finish (except M3 & S3).

## BUSHING

**D1** .177" HIGH, UNTHREADED

**F1** ESD, CONDUCTIVE BUSHING UNTHREADED, .177" HIGH

F1 bushing is not UL/CSA approved

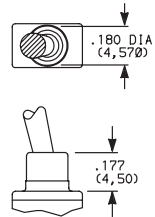

**NOTE:** ESD protection depends on proper grounding of switch support bracket. F1 conductive bushing option is impregnated with carbon fibers; dissipates electrostatic discharge (ESD) up to 20,000 V from actuator to ground.

Available with all metal actuator options and A, AV, AV3, V3 and V31 termination options only.

Internal actuator o-ring seal standard.

## TERMINATIONS

**C** PC THRU-HOLE

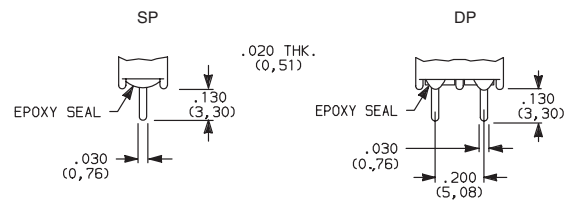

PC MOUNTING

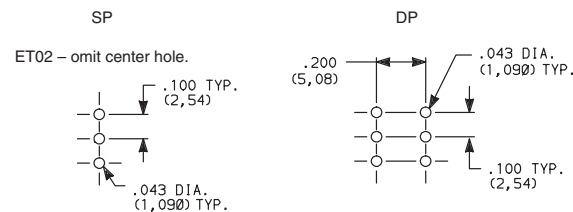

SP and DP

Not available with F1 conductive bushing.

**W** WIRE WRAP

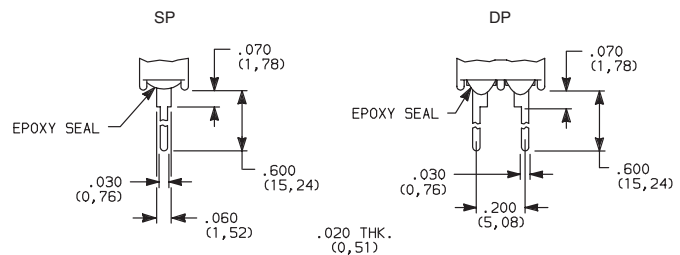

SP and DP

Not available with F1 conductive bushing.



Third Angle Projection

Dimensions are shown: Inch (mm)  
Specifications and dimensions subject to change



G

Toggle

**C&K**

# ET Series Sealed Subminiature Toggle Switches

## TERMINATIONS

**A** RIGHT ANGLE, PC THRU-HOLE

**ET01MD1ABE**  
Horizontal Actuation  
**SPDT**

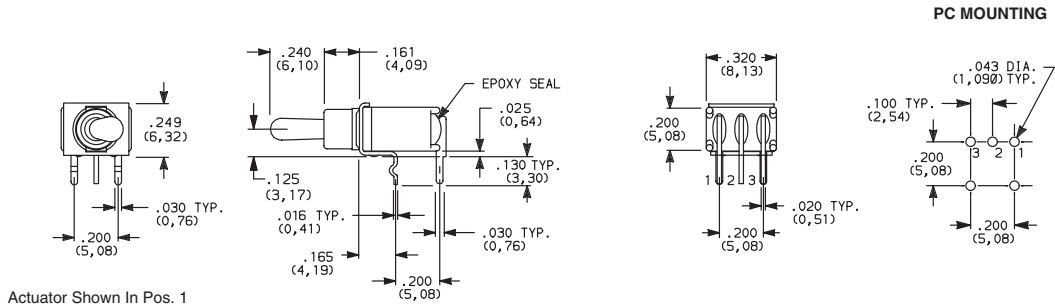

Not available with ET02 model.

**A** RIGHT ANGLE, PC THRU-HOLE

**ET21MD1ABE**  
Horizontal Actuation  
**DPDT**

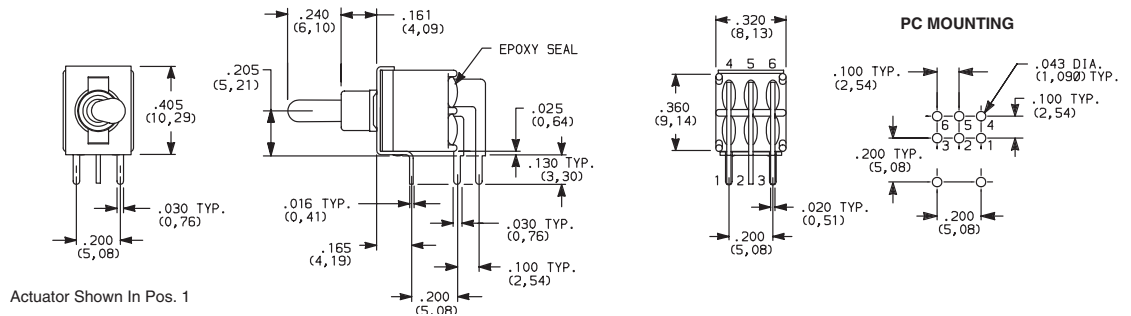

**AV** VERTICAL RIGHT ANGLE, PC THRU-HOLE

**ET01MD1AVBE**  
Vertical Actuation  
**SPDT**

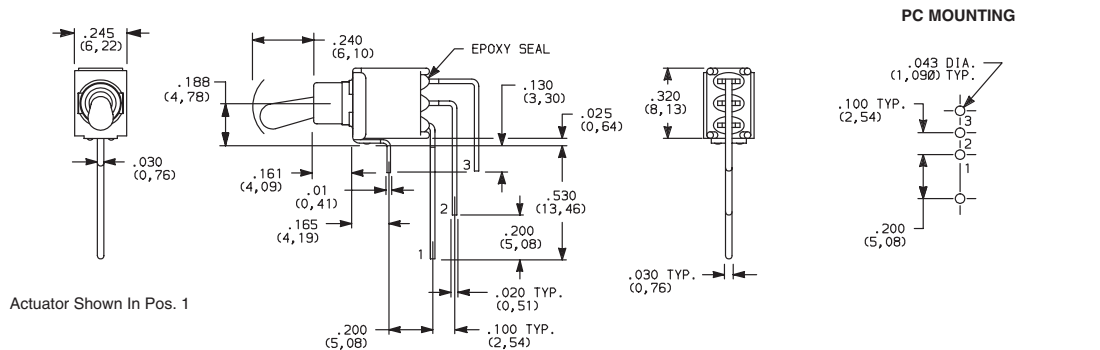

ET02 - omit terminal 2.

**NOTE:** Terminal bend radii and lead-in manufacturing option.

**AV** VERTICAL RIGHT ANGLE, PC THRU-HOLE

**ET21MD1AVBE**  
Vertical Actuation  
**DPDT**

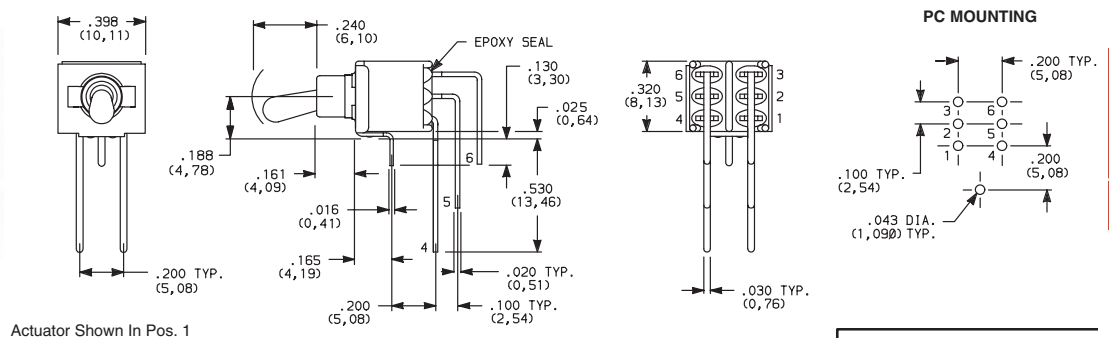

**NOTE:** Terminal bend radii and lead-in manufacturing option.

Third Angle Projection

Dimensions are shown: Inch (mm)  
Specifications and dimensions subject to change

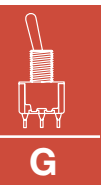

Toggle

# ET Series Sealed Subminiature Toggle Switches

## TERMINATIONS

### AV3 VERTICAL RIGHT ANGLE, SNAP-IN, PC THRU-HOLE

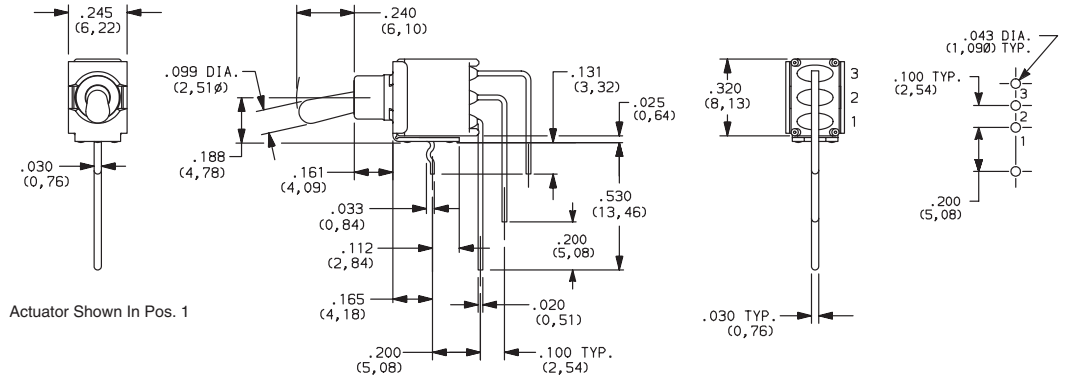

### SA RIGHT ANGLE, SURFACE MOUNT

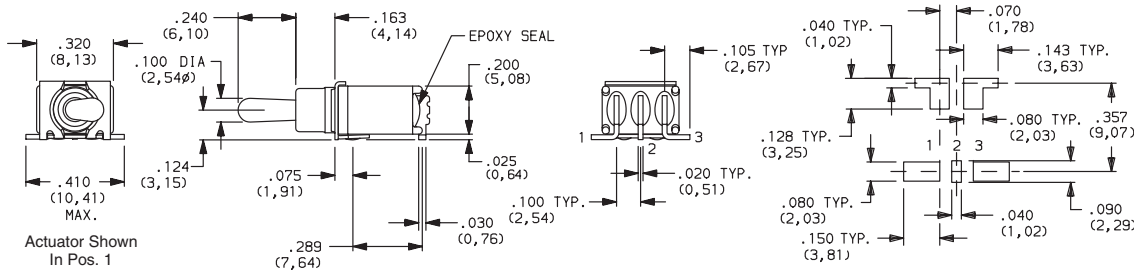

Not available with S and S1 actuators. Standard with tape & reel packaging. See page G-35.

### SA1 RIGHT ANGLE, SURFACE MOUNT

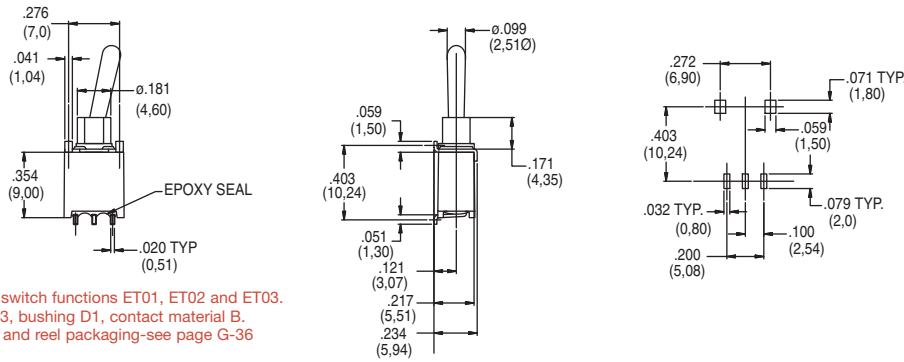

Only available with switch functions ET01, ET02 and ET03. Actuators M and M3, bushing D1, contact material B. Standard with tape and reel packaging-see page G-36

### V3 VERTICAL MOUNT, V-BRACKET

### V31 VERTICAL MOUNT, V-BRACKET, SNAP-IN

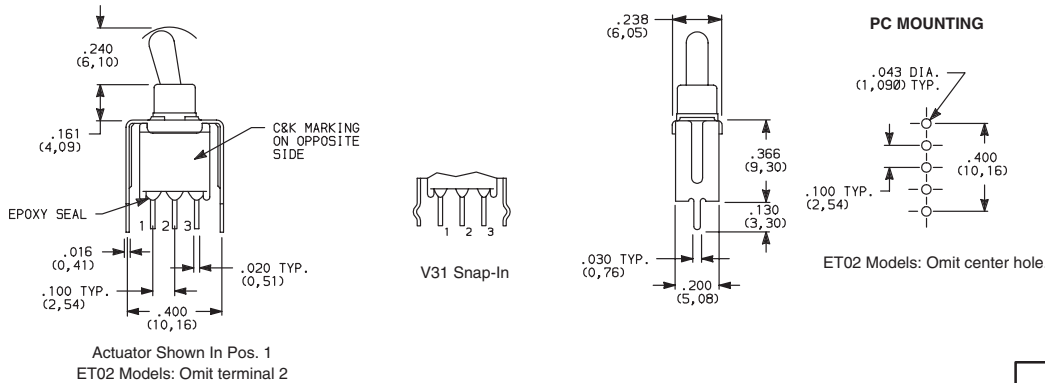

Actuator Shown In Pos. 1  
ET02 Models: Omit terminal 2

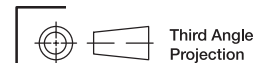

Dimensions are shown: Inch (mm)  
Specifications and dimensions subject to change

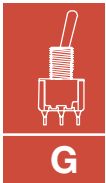

Toggle



# ET Series Sealed Subminiature Toggle Switches

## TERMINATIONS

### V3 VERTICAL MOUNT, V-BRACKET

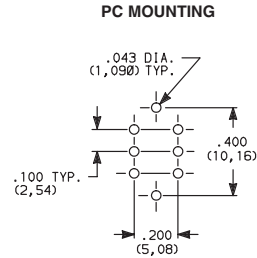
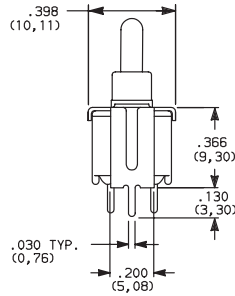
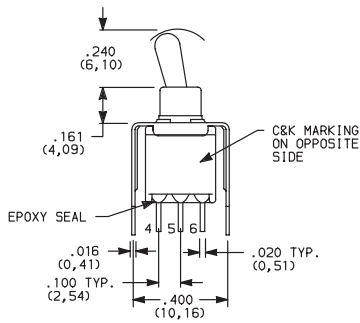

ET21MD1V3BE  
DPDT

## CONTACT MATERIAL

OPTION CODE	CONTACT MATERIAL	TERMINAL PLATING	RATINGS	
B	GOLD 1	GOLD 1	LOW LEVEL/DRY CIRCUIT	0.4 VA MAX. @ 20 V AC OR DC MAX.
P		MATTE-TIN 6		
Q	SILVER 4,5	SILVER 5	POWER	ETX1 MODELS: 3 AMPS @ 120 V AC OR 28 V DC ALL OTHER MODELS: 2 AMPS @ 120 V AC OR 28 V DC
S		MATTE-TIN 6		
G	GOLD OVER SILVER 2,3	GOLD 3	LOW LEVEL/DRY CIRCUIT OR POWER	ETX1 MODELS: 0.4 VA MAX. @ 20 V AC OR DC MAX. OR 3 AMPS @ 120 V AC OR 28 V DC ALL OTHER MODELS: 0.4 VA MAX. @ 20 V AC OR DC MAX. OR 2 AMPS @ 120 V AC OR 28 V DC
R		MATTE-TIN 6		

\* Note: See Technical Data section of this catalog for RoHS compliant and compatible definitions and specifications.

- 1 CONTACTS & TERMINALS: Copper alloy, with gold plate over nickel plate.
- 2 END CONTACTS: Coin silver, with gold plate over nickel plate.
- 3 CENTER CONTACTS & ALL TERMINALS: Copper alloy, with gold plate over nickel plate.
- 4 END CONTACTS: Coin silver, silver plated.
- 5 CENTER CONTACT & ALL TERMINALS: Copper alloy, silver plated.
- 6 TERMINALS: Copper alloy, with matte tin over nickel plate.

**NOTE:** Any models supplied with Q, B, G, P or R contact material are RoHS compliant.

All models  with all options (except M3 actuator) when ordered with G, L, R or Q contact material except with F1 conductive bushing.

K, L and M options represent Non RoHS tin lead product and are not recommended for new designs. For additional information please contact Customer Service.

## SEAL

### E EPOXY SEAL

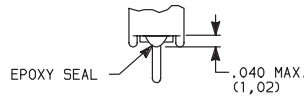

## AVAILABLE HARDWARE

### Cap

#### PART NO.

- 706201000 WHITE
- 706202000 BLACK
- 706203000 RED

Material: Vinyl  
Finish: Matte

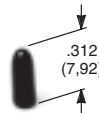

**NOTE:** Other colors available, consult Customer Service Center.

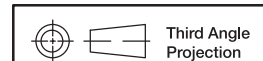

Dimensions are shown: Inch (mm)  
Specifications and dimensions subject to change



G

Toggle

# ET Series Sealed Subminiature Toggle Switches

## TAPE & REEL

For part number ET01M3D1SAKE

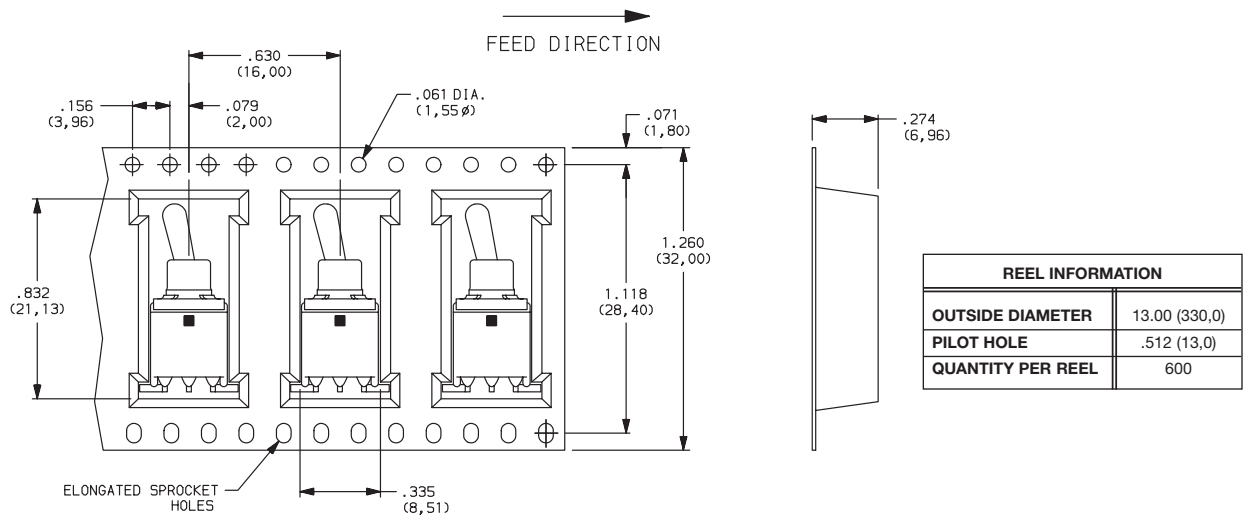

For part number ET01M3D1SA1BE

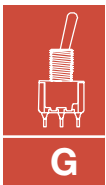
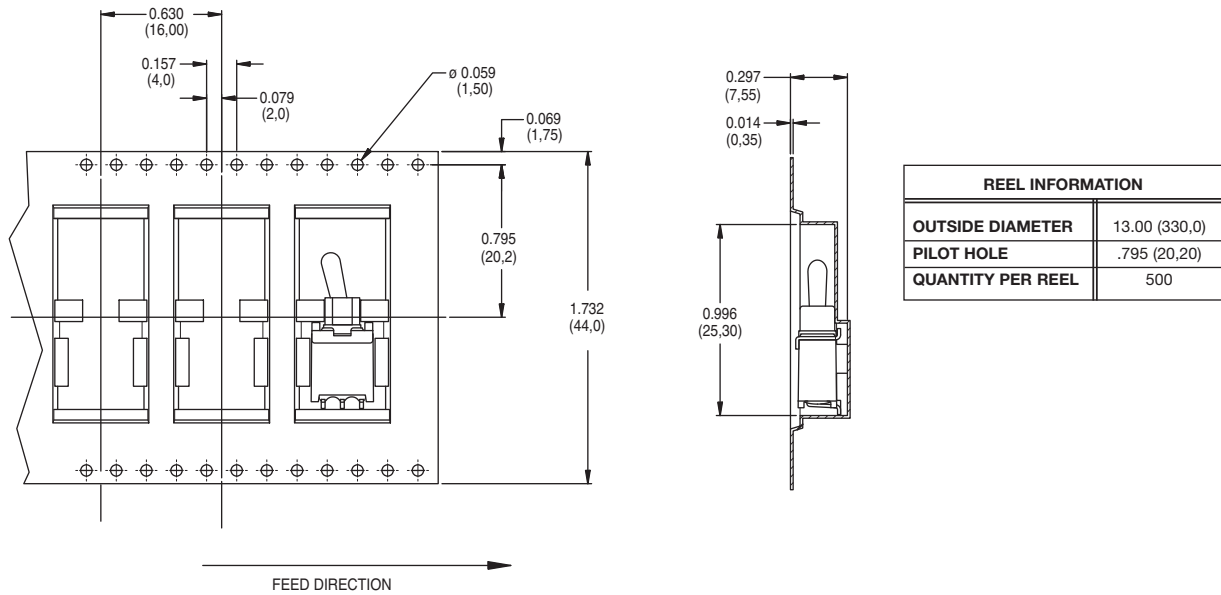

Toggle

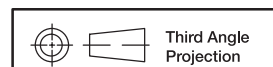

Dimensions are shown: Inch (mm)  
Specifications and dimensions subject to change