

# C&K SDA Series Low Profile DIP Switches



DIP I



## Features/Benefits

- Low profile design saves space
- Thru-hole and surface mount models
- High pressure contact does not require tape sealing
- Tape and reel packaging available

## Typical Applications

- Address switch for industrial controls
- Logic switching for computers and peripherals
- Function controlling for numerous applications

## How To Order

Complete part numbers for SDA Series are shown on pages H-4 thru H-6. All switches supplied in "OFF" position.

## Specifications

CONTACT RATING: 25 mA @ 24 V DC or 100 mA @ 50 V DC.  
MECHANICAL AND ELECTRICAL LIFE: 1,000 cycles at rated loads.

CONTACT RESISTANCE: 50 milliohms max. initial.

INSULATION RESISTANCE: 100 megohms between terminals.

DIELECTRIC WITHSTANDING VOLTAGE: 300 V DC min. for 1 minute.

STORAGE TEMPERATURE: -40°C to 85°C.

OPERATING TEMPERATURE: -20°C to 85°C.

OPERATING FORCE: 800 grams max.

SOLDERABILITY: Dip and look solderability testing per C&K spec. #448. Unplated edges of terminals permitted.

PACKAGING: Switches supplied in rigid dispensing tubes in full-tube quantities only, this may affect order quantity. Numbers of switches per tube varies with model. Tape and reel packaging also available.

## Materials

HOUSING: PPA color: Red (UL 94V-0).

COVER: PPA color: Red (UL 94V-0).

ACTUATOR: Nylon (UL 94V-0).

CONTACTS: Gold plated Beryllium copper.

TERMINALS: Tin lead plated brass.

TAPE SEAL: Polyamide.

**NOTE:** Specifications and materials listed above are for switches with standard options. For information on specific and custom switches, consult Customer Service Center.

## Flush Actuator – No Tape, Thru-hole Terminals



SDA08H0KD

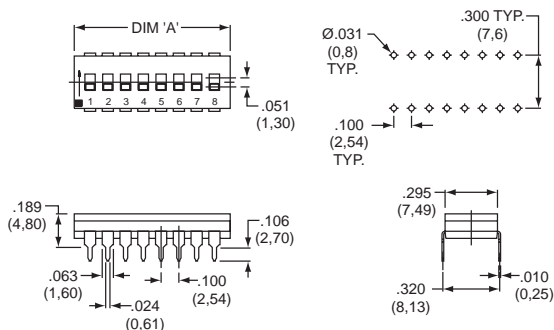

PART NUMBER	NO.POS.	DIM. 'A'	QUANTITY PER TUBE
SDA02H0KD	2	.278 (7,06)	85
SDA03H0KD	3	.378 (9,60)	60
SDA04H0KD	4	.476 (12,10)	45
SDA05H0KD	5	.578 (14,68)	40
SDA06H0KD	6	.676 (17,18)	30
SDA07H0KD	7	.778 (19,76)	25
SDA08H0KD	8	.876 (22,26)	25
SDA09H0KD	9	.978 (24,84)	20
SDA10H0KD	10	1.076 (27,34)	20
SDA12H0KD	12	1.279 (32,50)	15

Schematic



SPST

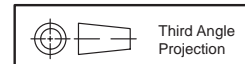



H  
DIP

## Flush Actuator – With Top Tape, Thru-hole Terminals

PART NUMBER	NO.POS.	DIM. 'A'	QUANTITY PER TUBE
<b>SDA02H0K</b>	2	.278 (7,06)	85
<b>SDA03H0K</b>	3	.378 (9,60)	60
<b>SDA04H0K</b>	4	.476 (12,10)	45
<b>SDA05H0K</b>	5	.578 (14,68)	40
<b>SDA06H0K</b>	6	.676 (17,18)	30
<b>SDA07H0K</b>	7	.778 (19,76)	25
<b>SDA08H0K</b>	8	.876 (22,26)	25
<b>SDA09H0K</b>	9	.978 (24,84)	20
<b>SDA10H0K</b>	10	1.076 (27,34)	20
<b>SDA12H0K</b>	12	1.279 (32,50)	15

Schematic

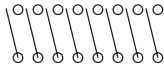

SPST

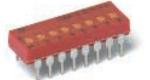
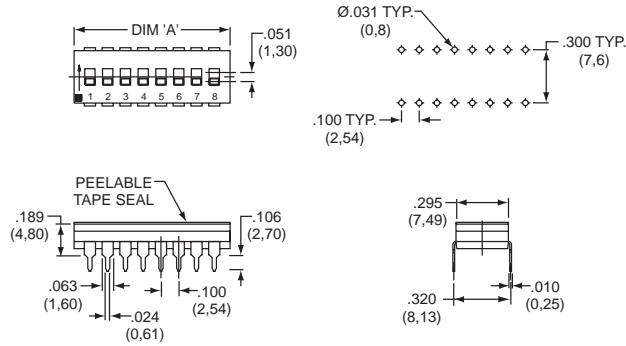

SDA08H0K

## Flush Actuator – With Top Tape, Surface Mount Terminals

PART NUMBER	NO.POS.	DIM. 'A'	QUANTITY PER TUBE
<b>SDA02H0SK</b>	2	.278 (7,06)	85
<b>SDA03H0SK</b>	3	.378 (9,60)	60
<b>SDA04H0SK</b>	4	.476 (12,10)	45
<b>SDA05H0SK</b>	5	.578 (14,68)	40
<b>SDA06H0SK</b>	6	.676 (17,18)	30
<b>SDA07H0SK</b>	7	.778 (19,76)	25
<b>SDA08H0SK</b>	8	.876 (22,26)	25
<b>SDA09H0SK</b>	9	.978 (24,84)	20
<b>SDA10H0SK</b>	10	1.076 (27,34)	20
<b>SDA12H0SK</b>	12	1.279 (32,50)	15

Schematic

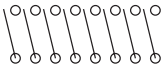

SPST

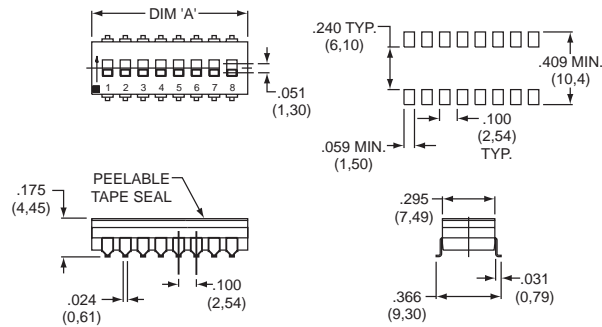

SDA08H0SK

## Flush Actuator – No Tape, Surface Mount Terminals

PART NUMBER	NO.POS.	DIM. 'A'	QUANTITY PER TUBE
<b>SDA02H0SKD</b>	2	.278 (7,06)	85
<b>SDA03H0SKD</b>	3	.378 (9,60)	60
<b>SDA04H0SKD</b>	4	.476 (12,10)	45
<b>SDA05H0SKD</b>	5	.578 (14,68)	40
<b>SDA06H0SKD</b>	6	.676 (17,18)	30
<b>SDA07H0SKD</b>	7	.778 (19,76)	25
<b>SDA08H0SKD</b>	8	.876 (22,26)	25
<b>SDA09H0SKD</b>	9	.978 (24,84)	20
<b>SDA10H0SKD</b>	10	1.076 (27,34)	20
<b>SDA12H0SKD</b>	12	1.279 (32,50)	15

Schematic

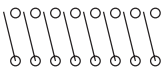

SPST

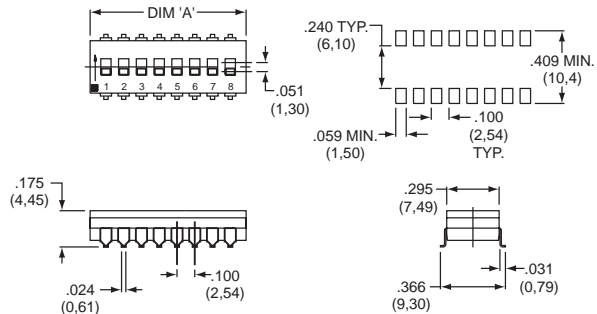

SDA08H0SKD

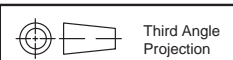

Third Angle  
Projection

# C&K SDA Series Low Profile DIP Switches

DIP 工

## Extended Actuator – No Top Tape, Thru-hole Terminals



SDA08H1KD

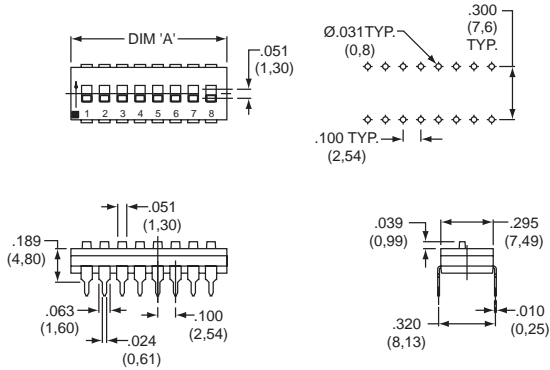

PART NUMBER	NO.POS.	DIM. 'A'	QUANTITY PER TUBE
SDA02H1KD	2	.278 (7,06)	85
SDA03H1KD	3	.378 (9,60)	60
SDA04H1KD	4	.476 (12,10)	45
SDA05H1KD	5	.578 (14,68)	40
SDA06H1KD	6	.676 (17,18)	30
SDA07H1KD	7	.778 (19,76)	25
SDA08H1KD	8	.876 (22,26)	25
SDA09H1KD	9	.978 (24,84)	20
SDA10H1KD	10	1.076 (27,34)	20
SDA12H1KD	12	1.279 (32,50)	15

Schematic

SPST

## Extended Actuator – No Top Tape, Surface Mount Terminals



SDA08H1SKD

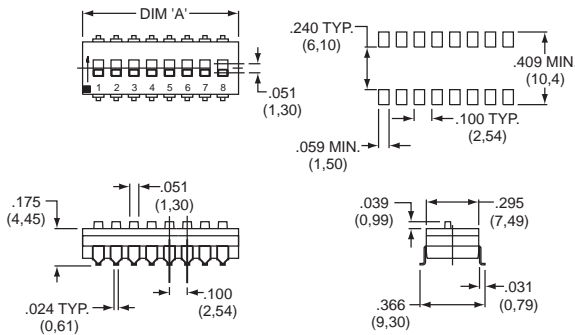

PART NUMBER	NO.POS.	DIM. 'A'	QUANTITY PER TUBE
SDA02H1SKD	2	.278 (7,06)	85
SDA03H1SKD	3	.378 (9,60)	60
SDA04H1SKD	4	.476 (12,10)	45
SDA05H1SKD	5	.578 (14,68)	40
SDA06H1SKD	6	.676 (17,18)	30
SDA07H1SKD	7	.778 (19,76)	25
SDA08H1SKD	8	.876 (22,26)	25
SDA09H1SKD	9	.978 (24,84)	20
SDA10H1SKD	10	1.076 (27,34)	20
SDA12H1SKD	12	1.279 (32,50)	15

Schematic

SPST

## Tape & Reel Packaging - Surface Mount Options only

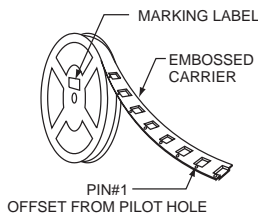
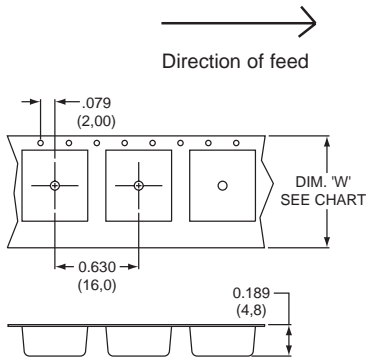

PART NUMBER	DIM. 'W'	QUANTITY PER REEL
SDA02H0SKR	.945 (24,0)	750
SDA03H0SKR	.945 (24,0)	750
SDA04H0SKR	.945 (24,0)	750
SDA05H0SKR	.945 (24,0)	750
SDA06H0SKR	1.26 (32,0)	750
SDA07H0SKR	1.26 (32,0)	750
SDA08H0SKR	1.73 (44,0)	750
SDA09H0SKR	1.73 (44,0)	750
SDA10H0SKR	1.73 (44,0)	750
SDA12H0SKR	1.73 (44,0)	750

