

MPS Series Magnetic Proximity Sensors

Features/Benefits

- Long life—10M operations
- Sealed contacts
- Quality construction
- Quick and easy installation

Typical Applications

- Automotive sensors and indicators
- Industrial sensors
- Factory automation equipment



Specifications

CONTACT RATINGS: 3.0 W max. @ 30 V DC or 30 V AC max. @ 0.3 AMP max.; 1.0 msec. max. operate time (including bounce); 1.0 AMP max. carry current.

CONTACT RESISTANCE: 100 m Ω max. initial.

DIELECTRIC STRENGTH: 200 V DC min.

ELECTRICAL CIRCUIT: SPST NO (Contact Form A). Reed switch opens when magnet is removed from proximity. Contacts are held closed when magnet is within actuation range.

OPERATING TEMPERATURE: -40°F to 212°F (-40°C to 100°C).

OPERATING DISTANCE/ALIGNMENT: Operate (pull-in or make) points are nominal values with ± 10% tolerance. Release points are 110% to 150% of the operating points.

MECHANICAL & ELECTRICAL LIFE: 10 million operations.

PACKAGING: Bulk packaging, 10 switch and magnet pairs per package.

Materials

HOUSING/SPACER/COVER: ABS plastic (UL94V-0), white.

REED SWITCH: Rhodium coated reed contacts in hermetically sealed, nitrogen filled glass capsule. Closed when magnet is in close proximity. Used in closed loop circuits.

WIRE LEADS: UL 1061, 22 AWG wire: stranded, made of copper or aluminum; Length: 12 in. with ends stripped; Color: white.

POTTING (around wires): Epoxy.

MAGNETS: Alnico V (all models, except MPS80WG) and Ceramic Ferrite 8 (MPS80WG model only).

ADHESIVE MOUNTING: Foam-backed, pressure-sensitive adhesive with release liner (MPS45WGW model only).

NOTE: Specifications and materials listed above are for switches with standard options. For information on specific and custom switches, consult Customer Service Center.

How To Order

Complete part numbers for MPS Series Magnetic Proximity Sensors are shown on pages F-23 thru F-25.



PART NUMBER	SWITCH TYPE
MPS45WGW	Subminiature surface mount (adhesive or flange), side exit leads, 1" make gap.

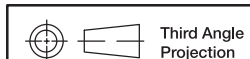
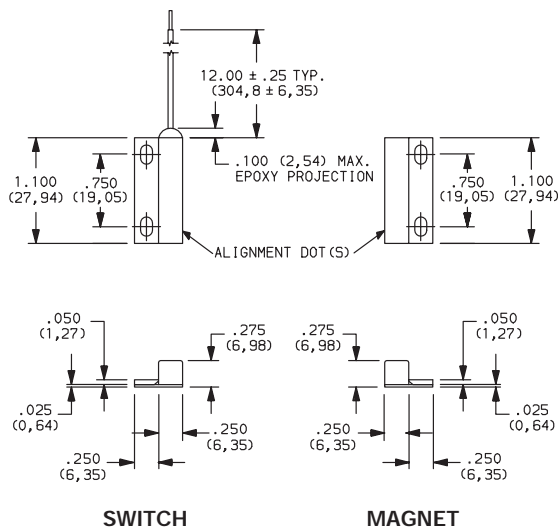
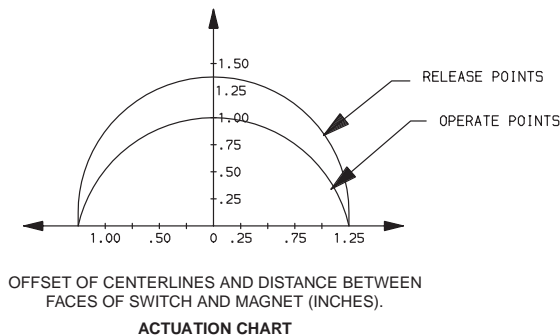

Dimensions are shown: Inches (mm)

Specifications and dimensions subject to change



F

Detect

MPS Series Magnetic Proximity Sensors

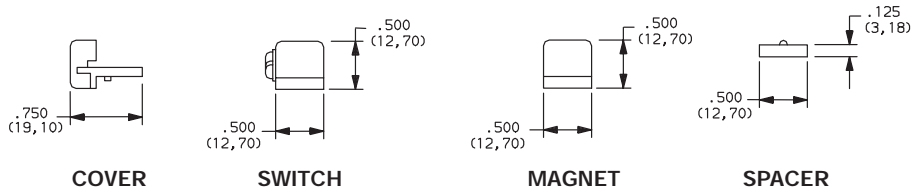
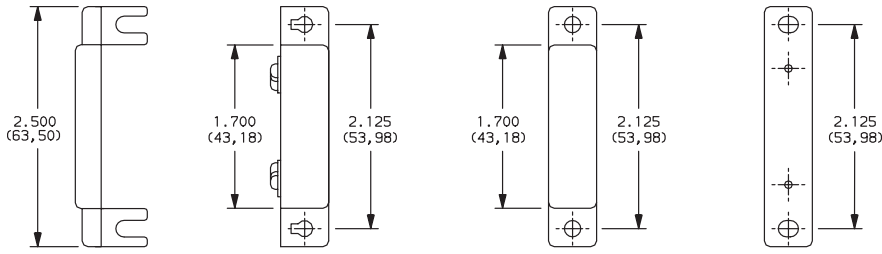

PART NUMBER	SWITCH TYPE
MPS20WGW	Standard surface mount, screw terminals, 1 1/4" make gap.

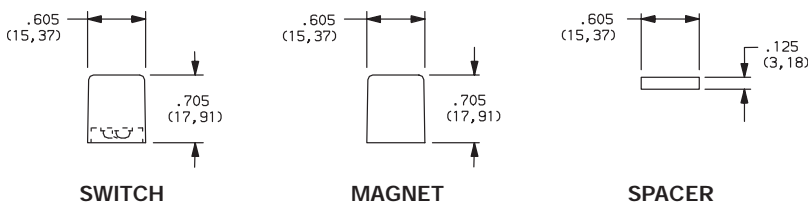
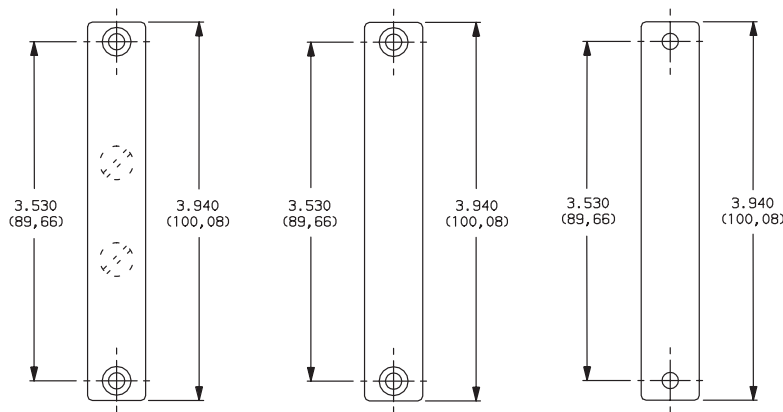
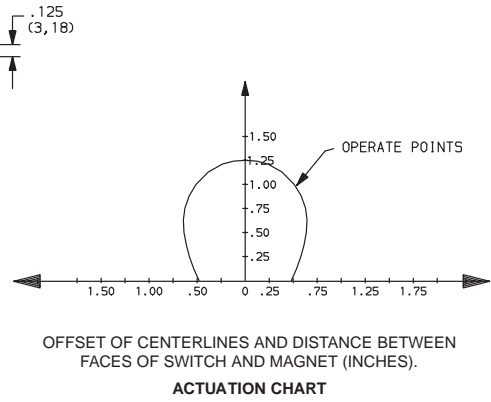

PART NUMBER	SWITCH TYPE
MPS80WGW	Industrial surface mount, concealed screw terminals, 2" make gap.

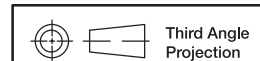
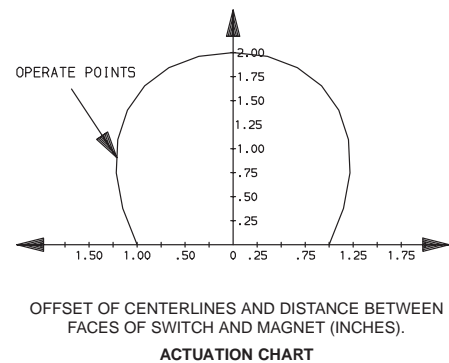

Dimensions are shown: Inches (mm)
Specifications and dimensions subject to change

MPS Series Magnetic Proximity Sensors

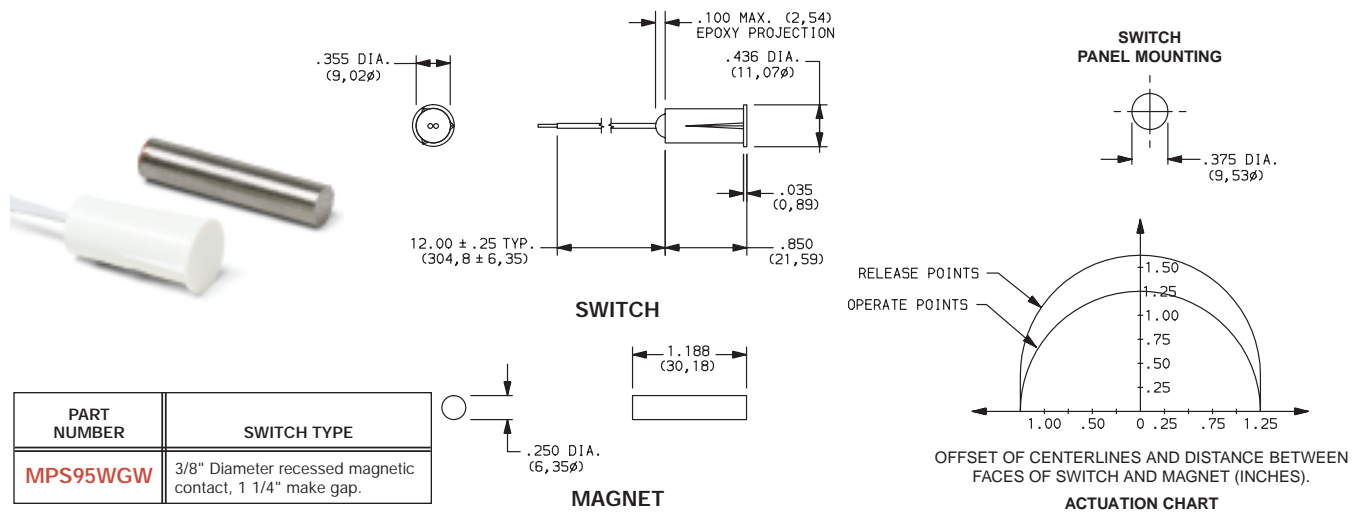
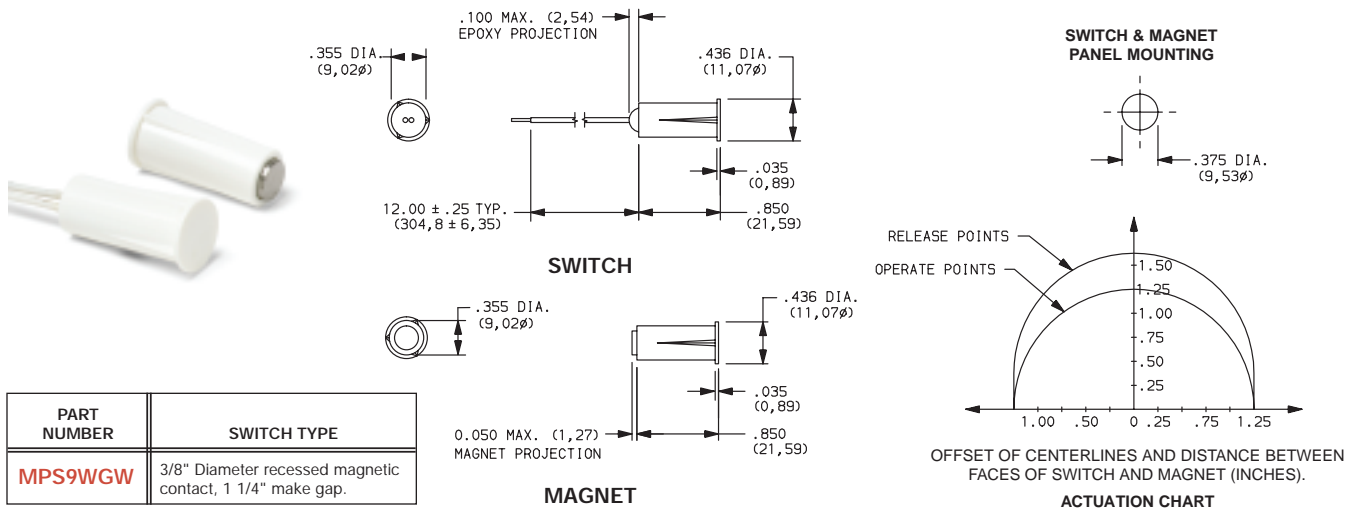

Detect

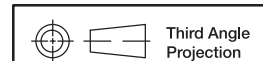

Third Angle Projection
Dimensions are shown: Inches (mm)
Specifications and dimensions subject to change

MPS Series Magnetic Proximity Sensors

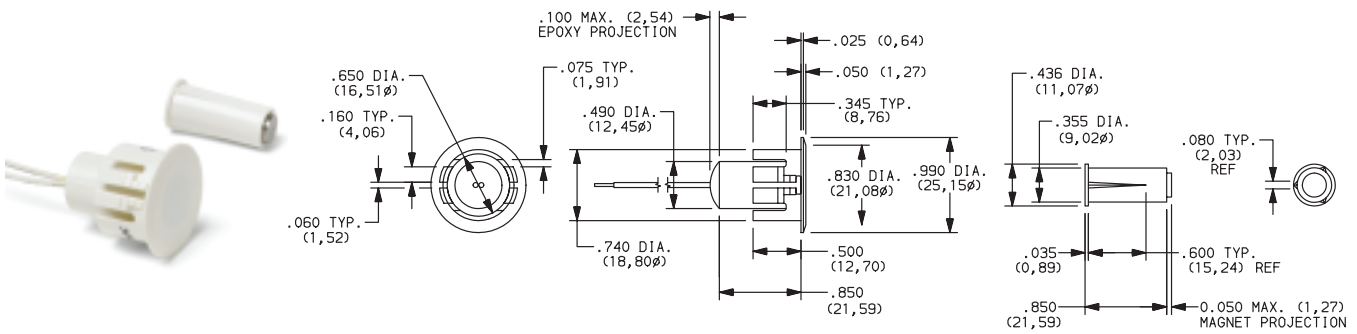

SWITCH
PANEL MOUNTING

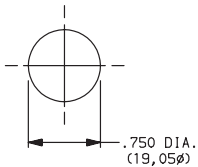

MAGNET
PANEL MOUNTING

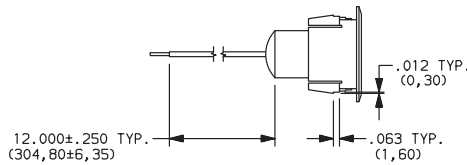
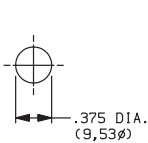

SWITCH

MAGNET

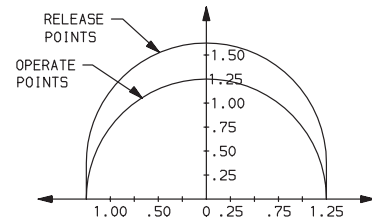

OFFSET OF CENTERLINES AND DISTANCE BETWEEN
FACES OF SWITCH AND MAGNET (INCHES).

ACTUATION CHART

PART NUMBER	SWITCH TYPE
MPS73WGW	3/4" Diameter recessed magnetic contact, 1 1/4" make gap.

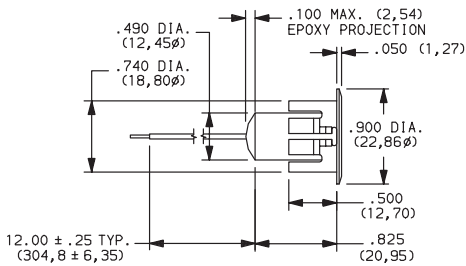

SWITCH

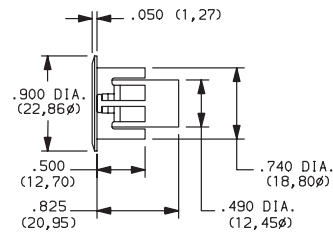

MAGNET



SWITCH & MAGNET
PANEL MOUNTING

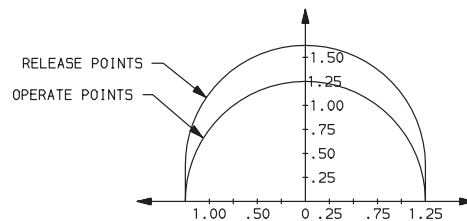
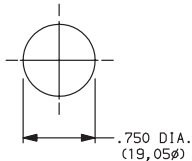

OFFSET OF CENTERLINES AND DISTANCE BETWEEN
FACES OF SWITCH AND MAGNET (INCHES).

ACTUATION CHART

PART NUMBER	SWITCH TYPE
MPS70WGW	3/4" Diameter recessed magnetic contact, 1 1/4" make gap.

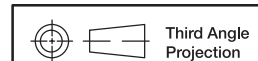

Dimensions are shown: Inches (mm)
Specifications and dimensions subject to change



D

Detect

MPS Series Magnetic Proximity Sensors

Actuating Positions

When installing recessed and surface mount contacts, magnet position is very important. The switch and magnet must always be parallel or end to end, and never in a 'T' configuration.

Gap Distance

Gap distance is a combination of the horizontal and vertical plane separation of the switch and magnet. Example: if a recessed magnet is 1/4" off the centerline of the switch, the make gap is reduced by 1/4"

Correct Configuration

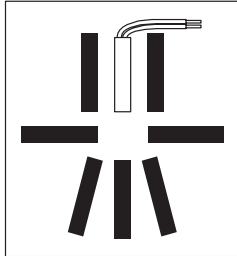

Incorrect Configuration

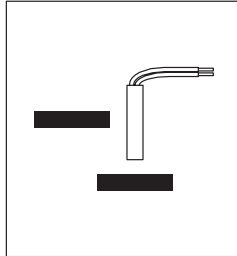

Center Alignment

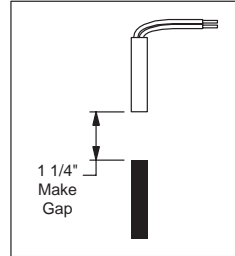

Off Center Alignment

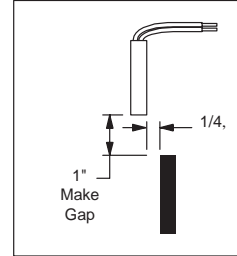

F

Detect



Third Angle
Projection

Dimensions are shown: Inches (mm)
Specifications and dimensions subject to change