

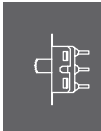







Slides







Product Selection Guide



Slide ↩

Slide							
Series	ES	TS	1000	GS	L	LP	S
Switch Type	Tiny	Tiny	Miniature	Ultra-miniature	Miniature	Miniature	Power
Poles	1 & 2	1	1 & 2	1	1 & 2	1 & 2	1 & 2
Momentary			•		•		•
Process Sealed	•			•			
Splashproof	•				•		
Screwdriver Slot					•		•
Housing Marking						•	•
Tape & Reel	•			•			
Max. Current	0.4 VA	3 A	6 A	0.4 VA	4 A	11 A	15 A
Terminations							
Wire Wrap		•	•		•		
Quick Connect			•				•
Wire Lead					•	•	•
Solder Lug			•		•	•	•
PC	•	•	•	•	•		•
PCB Mount Options							
Thru-hole	•	•	•	•	•	•	•
Vertical	•	•	•	•	•	•	•
Right Angle	•	•	•	•			•
Surface Mount	•			•			
Panel Mount Options							
Snap-in						•	•
Mounting Ears			•		•		•
Right Angle	•	•	•	•			•
Page No.	J-4	J-8	J-11	J-17	J-19	J-25	J-28

Slides Product Selection Guide

Slide						
Series	V	OS	PCM	AYZ	JS	JSM
Switch Type	Power & Line Voltage	Miniature	Low Profile	Low Profile	Low Profile	Low Profile
Poles	1 & 2	1 & 2	1 & 2	1 & 2	1 & 2	1
Momentary						•
Process Sealed						
Splashproof						
Screwdriver Slot	•					
Housing Marking						
Tape & Reel			•		•	•
Max. Current	10.1 A	200mA	0.3A	100mA	0.3A	0.3A
Terminations						
Wire Wrap						
Quick Connect	•					
Wire Lead						
Solder Lug		•				
PC	•	•	•	•	•	
PCB Mount Options						
Thru-hole	•	•			•	
Vertical	•	•			•	
Right Angle	•	•			•	
Surface Mount			•	•	•	•
Panel Mount Options						
Snap-in	•					
Mounting Ears	•	•				
Right Angle	•					
Page No.	J-33	J-37	J-44	J-46	J-49	J-54



Slide

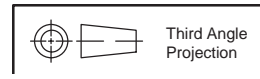

*Dimensions are shown: Inch (mm)
Specifications and dimensions subject to change*

ES Series Sealed Tiny Slide Switches

Features/Benefits

- Process compatible—internal o-ring and epoxy base seal
- Thru-hole & surface mount models
- Reliable contact design ensures long electrical life
- Robust actuator for easy actuation
- RoHS compliant

Typical Applications

- Computer peripherals & network products
- Test & measurement equipment
- Telephone & cable modems



Patent No. 6,008,458

Slide ↩

Specifications

CONTACT RATING: 0.4 VA max. @ 20 V AC or DC max.
 MECHANICAL & ELECTRICAL LIFE: 40,000 make-and-break cycles at full load.
 CONTACT RESISTANCE: 50 m Ω max. initial @ 2-4 V DC, 100 mA.
 INSULATION RESISTANCE: 10⁹ Ω min.
 DIELECTRIC STRENGTH: 500 Vrms min.
 OPERATING TEMPERATURE: -30°C to 85°C.
 SOLDERABILITY: Per MIL-STD-202F method 208D, or EIA RS-186E method 9.
 DEGREE OF PROTECTION: IP57; Protection against harmful dust deposit, full-scale voltage protection, temporary immersion.
 ESD ENDURANCE: 8kv min. (EIA 545).
 PACKAGING: Thru-hole switches supplied in anti-static trays. Surface mount switches available in tape and reel packaging.

Materials

HOUSING & BASE: Nylon (UL 94V-0).
 ACTUATOR: LCP (UL 94V-0) black, standard.
 SURFACE PLATE: Stainless steel with tin plate.
 MOVABLE CONTACT: Bronze with gold plate over nickel plate.
 STATIONARY CONTACTS: Copper alloy, with gold plate over nickel plate.
 TERMINALS: Copper alloy, with gold over nickel plate. All terminals insert molded.
 BASE & TERMINAL SEAL: Epoxy.

NOTE: All models RoHS compliant and compatible with all options.

NOTE: Specifications and materials listed above are for switches with standard options. For information on specific and custom switches, consult Customer Service Center.

How To Order

Complete part numbers for ES Series Sealed Tiny Slide Switches are shown on pages J-5 through J-7. These unique tiny slide switches are process compatible. An internal o-ring and epoxy base seal protects the switch from wave and reflow soldering, as well as cleaning processes.

PART NUMBER	SWITCH FUNCTION		
	POS. 1	POS. 2	POS. 3
ES01MCBE	ON	NONE	ON
ES03MCBE	ON	OFF	ON
CONN. TERMINALS	2-3	OPEN	2-1
SCHEMATIC			
SPDT			
ES02MCBE	OFF	NONE	ON
CONN. TERMINALS	OPEN	N/A	3-1
SCHEMATIC			
SPST			

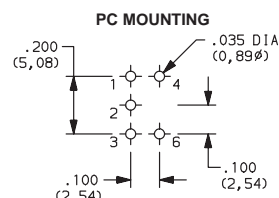
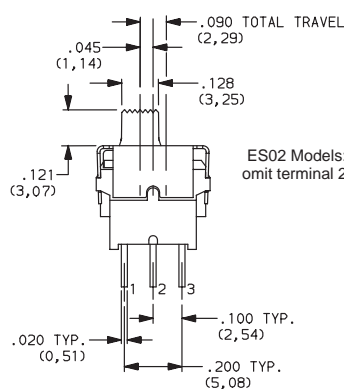
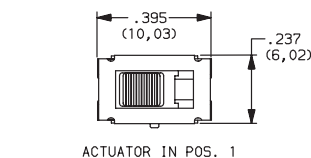

ES01MCBE
SPDT

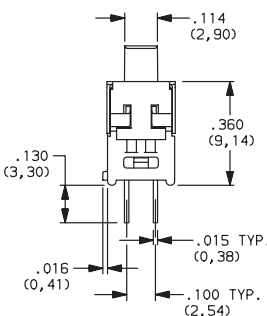

Dimensions are shown: Inch (mm)
 Specifications and dimensions subject to change



ES Series Sealed Tiny Slide Switches



**ES21MCBE
DPDT**

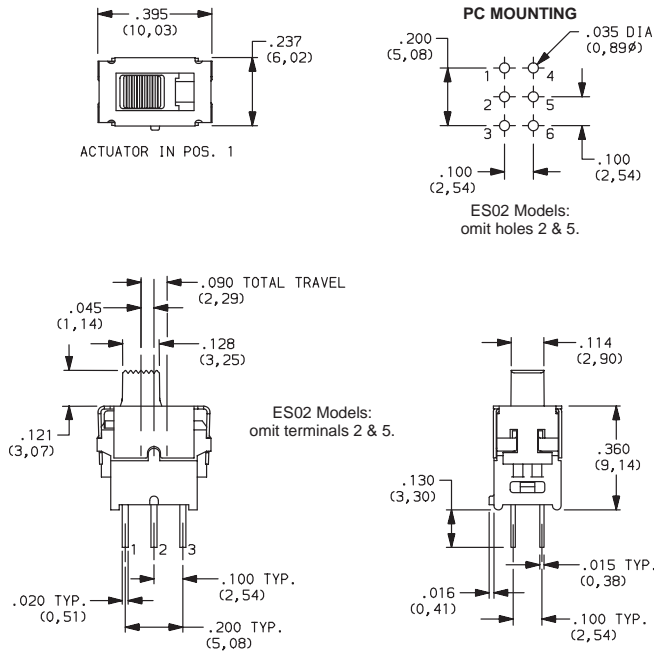

PART NUMBER	SWITCH FUNCTION		
	POS. 1	POS. 2	POS. 3
ES21MCBE	ON	NONE	ON
ES23MCBE	ON	OFF	ON
CONN. TERMINALS	2-3, 5-6	OPEN	2-1, 5-4
SCHEMATIC			
DPDT			
ES22MCBE	OFF	NONE	ON
CONN. TERMINALS	OPEN	N/A	3-1, 6-4
SCHEMATIC			
DPST			



**ES21MABE
DPDT**

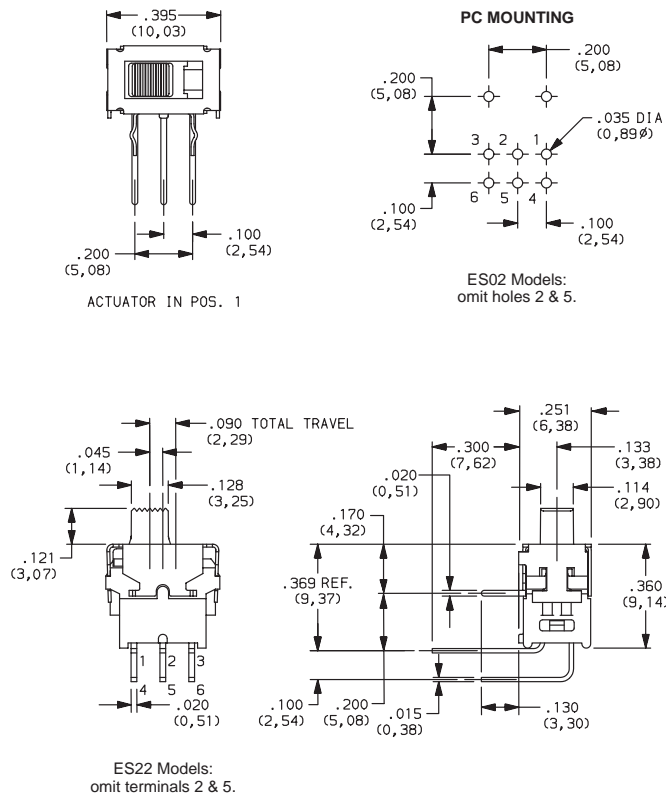

PART NUMBER	SWITCH FUNCTION		
	POS. 1	POS. 2	POS. 3
ES21MABE	ON	NONE	ON
ES23MABE	ON	OFF	ON
CONN. TERMINALS	2-3, 5-6	OPEN	2-1, 5-4
SCHEMATIC			
DPDT			
ES22MABE	OFF	NONE	ON
CONN. TERMINALS	OPEN	N/A	3-1
SCHEMATIC			
DPST			

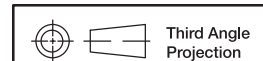

Dimensions are shown: Inch (mm)
Specifications and dimensions subject to change



Slide

ES Series Sealed Tiny Slide Switches

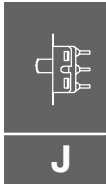

Slide ↩

PART NUMBER	SWITCH FUNCTION		
	POS. 1	POS. 2	POS. 3
ES01MAVBE	ON	NONE	ON
ES03MAVBE	ON	OFF	ON
CONN. TERMINALS	2-3	OPEN	2-1
SCHEMATIC			

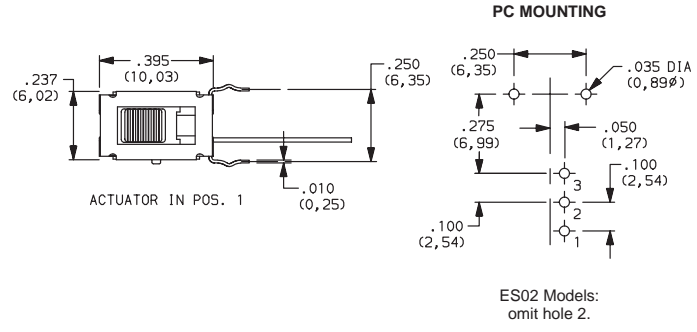

**ES01MAVBE
SPDT**

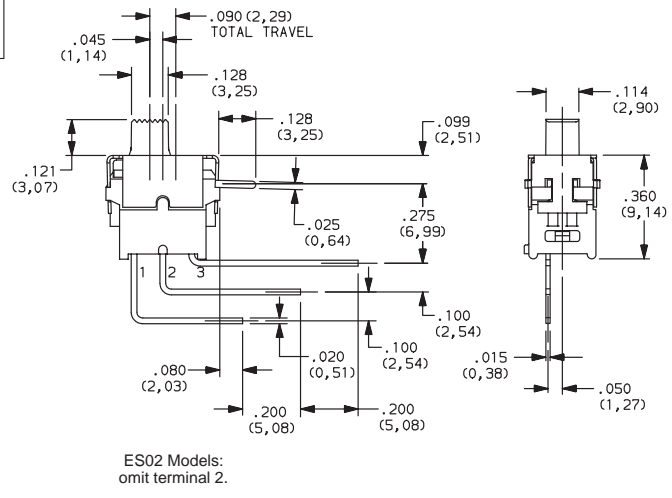

PART NUMBER	SWITCH FUNCTION		
	POS. 1	POS. 2	POS. 3
ES01MSABE	ON	NONE	ON
ES03MSABE	ON	OFF	ON
CONN. TERMINALS	2-3	OPEN	2-1
SCHEMATIC			
SPDT			
ES02MSABE	OFF	NONE	ON
CONN. TERMINALS	OPEN	N/A	3-1
SCHEMATIC			
SPST			

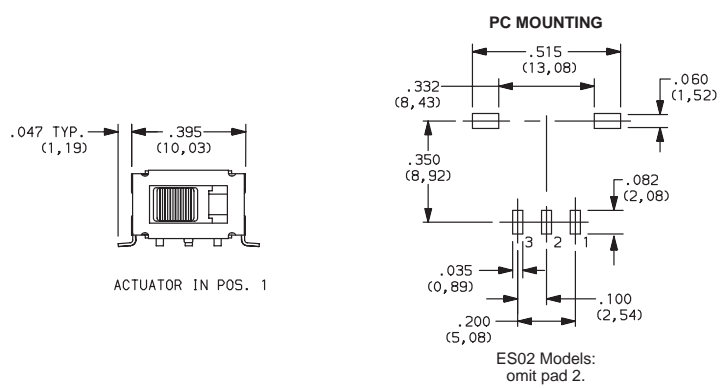

**ES01MSABE
Horizontal Actuation
SPDT**

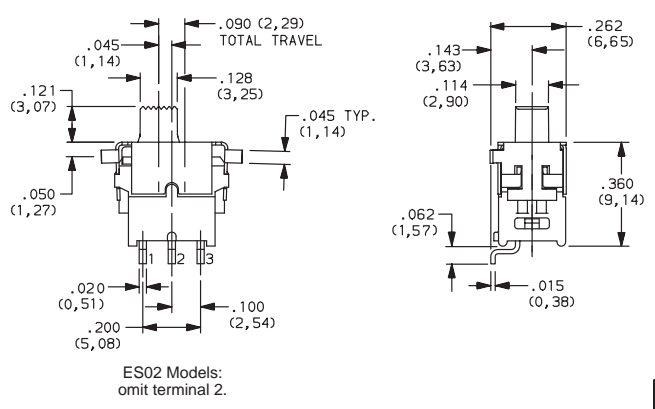

Dimensions are shown: Inch (mm)
Specifications and dimensions subject to change



ES Series Sealed Tiny Slide Switches

TAPE & REEL

For part numbers ESXXMSABE

REEL INFORMATION	
OUTSIDE DIAMETER	13.00 (330,0)
PILOT HOLE	.512 (13,0)
QUANTITY PER REEL	300

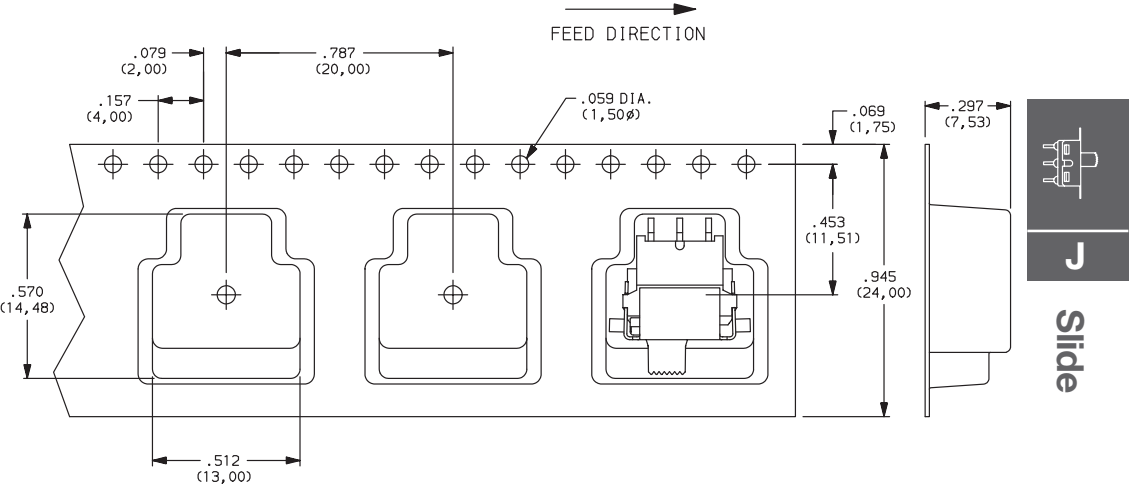

Dimensions are shown: Inch (mm)
Specifications and dimensions subject to change

TS Series Tiny Slide Switches

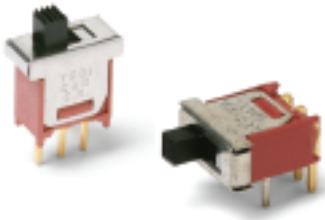

Features/Benefits

- **Reliable contact design ensures long electrical life**
- **Ratings up to 3 AMPS**
- **Epoxy terminal-seal compatible with bottom wash cleaning**
- **RoHS compliant**

Typical Applications

- **Test & measurement equipment**
- **Computers & peripherals**
- **Telecommunications & networking equipment**



Models Available



Slide

Specifications

CONTACT RATING: B contact material: 0.4 VA max. @ 20 V AC or DC max. Q contact material (TS01 Model): 3 AMPS @ 120 V AC or 28 V DC; (TS02, TS03 Models): 1 AMP @ 120 V AC or 28 V DC. See page I-10 for additional ratings.

ELECTRICAL LIFE:
TS01 MODELS: 60,000 make-and-break cycles at full load.
TS02, TS03 MODELS: 30,000 cycles.

CONTACT RESISTANCE: Below 20 m Ω typ. initial @ 2-4 V DC, 100 mA, for both silver and gold plated contacts.

INSULATION RESISTANCE: 10⁹ Ω min.

DIELECTRIC STRENGTH: 1,000 Vrms min. @ sea level.

OPERATING TEMPERATURE: -30°C to 85°C

SOLDERABILITY: Per MIL-STD-202F method 208D, or EIA RS-186E method 9 (1 hour steam aging).

Materials

CASE: Glass filled nylon 6/6, flame retardant, heat stabilized, or diallyl phthalate (DAP) (UL 94V-0).

ACTUATOR: Nylon, black standard.

HOUSING: Stainless steel or stainless steel, nickel plated.

END CONTACTS: B contact material: Copper alloy, with gold plate over nickel plate. Q contact material: Coin silver, silver plated. See page I-10 for additional contact materials.

CENTER CONTACT & ALL TERMINALS: B contact material: Copper alloy, with gold plate over nickel plate. Q contact material: Copper alloy, silver plated. See page J-10 for additional contact materials.

TERMINAL SEAL: Epoxy. Refer to Soldering and Cleaning in Technical Data chapter.

NOTE: Any models supplied with Q, B, G, P, S or R contact material are RoHS compliant.

NOTE: Specifications and materials listed above are for switches with standard options.

For information on specific and custom switches, consult Customer Service Center.

Build-A-Switch

To order, simply select desired option from each category and place in the appropriate box. Available options are shown and described on pages J-9 and J-10. For additional options not shown in catalog, consult Customer Service Center. All models have epoxy terminal seal and are compatible with all "bottom-wash" PCB cleaning methods.

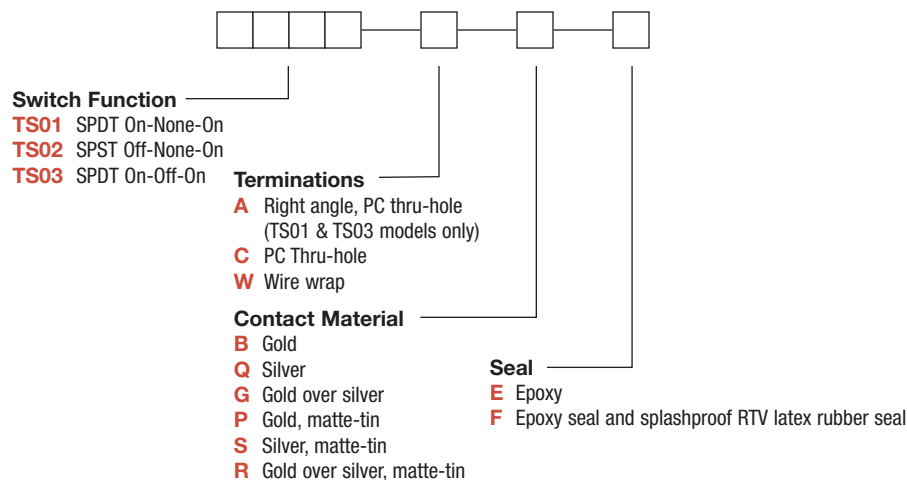

Dimensions are shown: Inch (mm)
Specifications and dimensions subject to change

TS Series Tiny Slide Switches

SWITCH FUNCTION

NO. POLES	MODEL NO.	SWITCH FUNCTION			CONNECTED TERMINALS			SCHEMATIC
		POS. 1	POS. 2	POS. 3	POS. 1	POS. 2	POS. 3	
		C&K marking on opposite side			C&K marking on opposite side			
SP	TS01	ON	NONE	ON	1-2	OPEN	2-3	
	TS03	ON	OFF	ON				
	TS02	OFF	NONE	ON	OPEN	N/A	3-1	
SPDT <p>Part number shown: TS01CBE</p> <p>Dimensions: .120 (3,05) TOTAL TRAVEL, .100 (2,54), .200 (5,08), .098 (2,49), .122 (3,10), .346 (8,79), .040 TYP. (1,02), .020 TYP. (0,51), .030 TYP. (0,76), .320 (8,13), .130 (3,30) TYP., .100 TYP. (2,54), .020 THK. (0,51)</p> <p>Labels: EPOXY SEAL, C&K MARKING OPPOSITE SIDE, Terminal Nos. For Reference Only</p> <p>TS02 models: Omit center terminal</p>								

All models with all options when ordered with G, L, M, Q, R or S contact material.
 TS02 model not available with A terminations.



TERMINATIONS

C PC THRU-HOLE

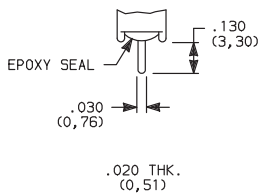

PC MOUNTING

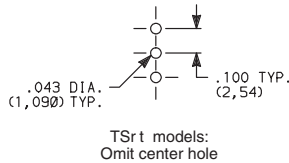

W WIRE WRAP

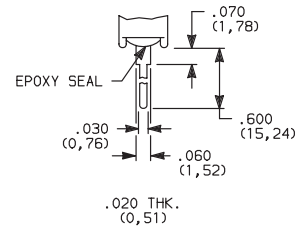

SPDT and SPST

SPDT and SPST

A RIGHT ANGLE, PC THRU-HOLE

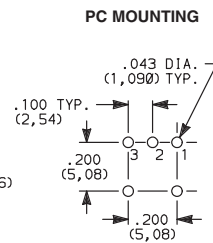
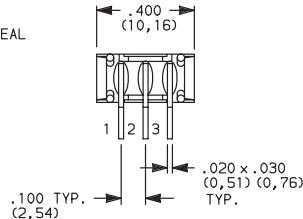
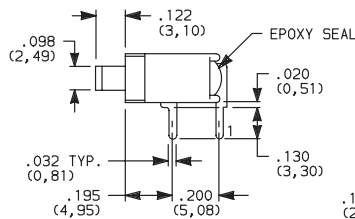
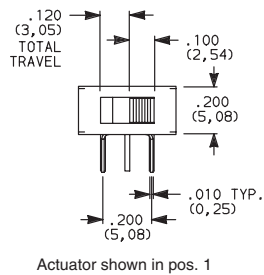

TS01ABE
Horizontal Actuation
SPDT

Not available with TS02 model.

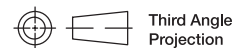

Third Angle Projection
 Dimensions are shown: Inch (mm)
 Specifications and dimensions subject to change

TS Series Tiny Slide Switches

CONTACT MATERIAL

OPTION CODE	CONTACT MATERIAL	TERMINAL PLATING	RATINGS	
B	GOLD ¹	GOLD ³	LOW LEVEL/DRY CIRCUIT	0.4 VA MAX. @ 20 V AC OR DC MAX.
P		MATTE-TIN ⁶		
Q	SILVER ^{4,5}	SILVER ⁵	POWER	TS01 MODELS: 3 AMPS @ 120 V AC OR 28 V DC. TS02, TS03 MODELS: 1 AMP @ 120 V AC OR 28 V DC.
S		MATTE-TIN ⁶		
G	GOLD OVER SILVER ^{2,3}	GOLD ³	LOW LEVEL/DRY CIRCUIT OR POWER	TS01 MODELS: 0.4 VA MAX @20 V AC OR DC MAX. OR 3 AMPS @ 120 V AC OR 28 V DC. TS02, TS03 MODELS: 0.4 VA MAX @ 20 V AC OR DC MAX. OR 1 AMP @ 120 V AC OR 28 V DC.
R		MATTE-TIN ⁶		

* Note: See Technical Data section of this catalog for RoHS compliant and compatible definitions and specifications.

¹ CONTACTS & TERMINALS: Copper alloy, with gold plate over nickel plate.



² END CONTACTS: Coin silver, with gold plate over nickel plate.

³ CENTER CONTACTS & ALL TERMINALS: Copper alloy, with gold plate over nickel plate.

⁴ END CONTACTS: Coin silver, silver plated.

⁵ CENTER CONTACT & ALL TERMINALS: Copper alloy, silver plated.

⁶ TERMINALS: Copper alloy, with matte-tin over nickel plate

All models   with all options when ordered with G, L, M, S or R contact material.

B contact material standard with A and W terminations.

Q contact material standard with C terminations.

NOTE: Any models supplied with Q, B, G, P, S or R contact material are RoHS compliant.

K, L and M options represent Non RoHS tin lead product and are not recommended for new designs. For additional information please contact Customer Service.

SEAL

E EPOXY SEAL

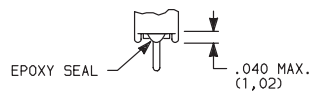

F EPOXY SEAL AND SPLASHPROOF RTV LATEX RUBBER SEAL



NOTE: RTV latex rubber seal peels off easily after installation. Epoxy terminal seal standard. Not available with A termination.



Dimensions are shown: Inch (mm)
Specifications and dimensions subject to change



Slide

1000 Series Miniature Slide Switches

Features/Benefits

- Variety of actuators and terminations
- Panel mount tabs available
- Epoxy terminal seal—compatible with bottom-wash cleaning
- RoHS compliant



Typical Applications

- Test & measurement equipment
- Telecommunications
- Computer & peripherals

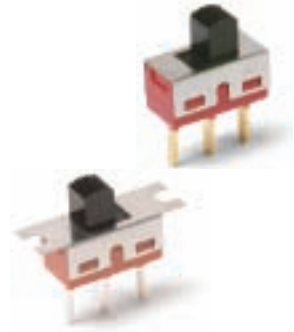

Specifications

CONTACT RATING: B contact material: 0.4 VA max. @ 20 V AC or DC max. Q contact material: 6 AMPS @ 120 V AC or 28 V DC, 3 AMPS @ 250 V AC. See page J-15 for additional ratings.

ELECTRICAL LIFE: 100,000 make-and-break cycles at full load on models with B, K or P contact material; 40,000 cycles on models with G, Q, L, M, S or R contact material.

CONTACT RESISTANCE: Below 10 m Ω typ. initial @ 2-4 V DC, 100 mA, for both silver and gold plated contacts.

INSULATION RESISTANCE: 10⁹ Ω min.

DIELECTRIC STRENGTH: 1,000 Vrms min. @ sea level.

OPERATING TEMPERATURE: -30°C to 65°C

SOLDERABILITY: Per MIL-STD-202F method 208D, or EIA RS-186E method 9 (1 hour steam aging).

Materials

CASE: diallyl phthalate (DAP), (UL 94V-0).

ACTUATOR: Nylon, black, standard.

HOUSING: Stainless steel.

SWITCH SUPPORT: Brass or steel, matte-tin plated.

END CONTACTS: B contact material: Copper alloy, with gold plate over nickel plate. Q contact material: Coin silver, silver plated. See page I-16 for additional contact materials.

CENTER CONTACT & ALL TERMINALS: B contact material: Copper alloy, with gold plate over nickel plate. Q contact material: Copper alloy, silver plated. See page J-16 for additional contact materials.

TERMINAL SEAL: Epoxy. Refer to Soldering and Cleaning in Technical Data chapter

NOTE: Any models supplied with Q, B, G, P, S or R contact material are RoHS compliant.

NOTE: Specifications and materials listed above are for switches with standard options.

For information on specific and custom switches, consult Customer Service Center.

Build-A-Switch

To order, simply select desired option from each category and place in the appropriate box. Available options are shown and described on pages J-12 through J-16. For additional options not shown in catalog, consult Customer Service Center. All models have epoxy terminal seal and are compatible with all “bottom-wash” PCB cleaning methods.

<p>Switch Function</p> <p>1101 SP On-None-On 1103 SP On-Off-On 1108 SP Mom-None-On 1201 DP On-None-On 1203 DP On-Off-On</p> <p>Mounting Style</p> <p>M2 PC mount without tabs M1 Panel mount with tabs</p> <p>Actuator</p> <p>S3 .200" high S1 .040" high S2 .140" high S4 .285" high S5 .370" high S6 .485" high T3 .200" high</p> <p>Terminations</p> <p>A Right angle, PC thru-hole C PC Thru-hole AV2 Vertical right angle, PC thru-hole Z Solder lug V3 V-bracket V4 V-bracket W .750" long, wire wrap Z3 Quick connect</p> <p>Contact Material</p> <p>B Gold Q Silver G Gold over silver P Gold, matte-tin S Silver, matte-tin R Gold over silver, matte-tin</p> <p>Seal</p> <p>E Epoxy D No epoxy seal I Epoxy potted base</p> <p>Actuator Color</p> <p>2 Black 1 White 3 Red 7 Blue</p>	
---	--



Dimensions are shown: Inch (mm)
Specifications and dimensions subject to change



Slide

1000 Series Miniature Slide Switches

SWITCH FUNCTION

NO. POLES	MODEL NO.	SWITCH FUNCTION			CONNECTED TERMINALS			SCHEMATIC
		POS. 1	POS. 2	POS. 3	POS. 1	POS. 2	POS. 3	
SP	1101	ON	NONE	ON	1-2	N/A	2-3	
	1103	ON	OFF	ON		OPEN		
	1108	MOM.	NONE	ON		N/A		
<p>SPDT</p> <p>Part number shown: 1101M2S3CQE2</p> <p>Terminal Nos. For Reference Only</p>								
DP	1201	ON	NONE	ON	2-1,5-4	OPEN	2-3,5-6	
	1203	ON	OFF	ON		DPDT		
<p>DPDT</p> <p>Part number shown: 1201M2S3CQE2</p> <p>Terminal Nos. For Reference Only</p>								

MOM. = Momentary

All models with all options when ordered with G, L, M, S or R contact material.

MOUNTING STYLE

M2 PC MOUNTING WITHOUT TABS



NOTE: Available with A, AV2, C, V3, V4, W terminations only.

M1 PANEL MOUNTING WITH TABS



NOTE: Available with C, W, Z, Z3 terminations only. No mounting hardware supplied.

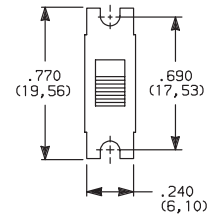

PANEL MOUNTING

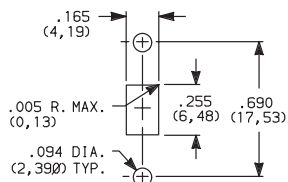

All actuators except T3.
Single pole

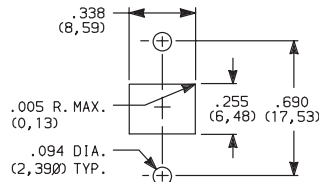

For T3 actuator only.
Double pole



Dimensions are shown: Inch (mm)
Specifications and dimensions subject to change



Slide

1000 Series Miniature Slide Switches

ACTUATOR

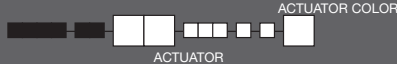

S3 .200" HIGH

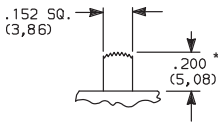

S2 .140" HIGH

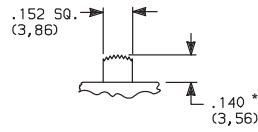

110X models only.

S1 .040" HIGH

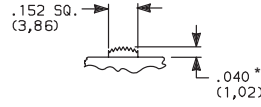

120X models only.

S4 .285" HIGH

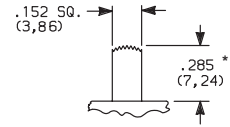

S5 .370" HIGH

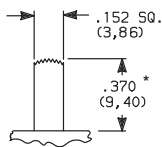

S6 .485" HIGH

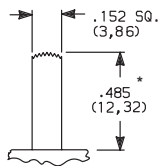

T3 .200" HIGH

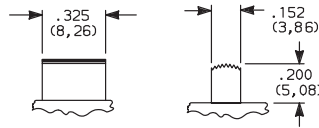

120X models only.

OPTION CODE	ACTUATOR COLOR
2	BLACK
1	WHITE
3	RED
7	BLUE
9	GRAY

Other colors available, consult Customer Service Center.

* Subtract .014 (0,36) from actuator height, all models with A, AV2, V3, V4 terminations.

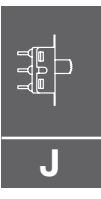

Slide

TERMINATIONS



Z SOLDER LUG

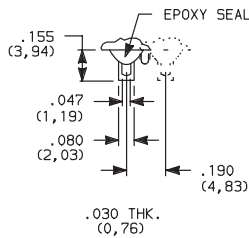

Not available with P, S or R contact materials.

SPDT & DPDT

C PC THRU-HOLE

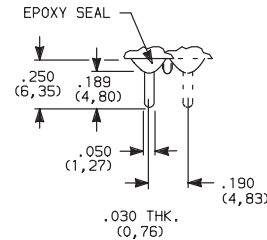

PC MOUNTING

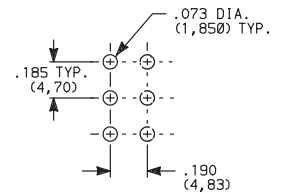

SPDT & DPDT

Z3 QUICK CONNECT

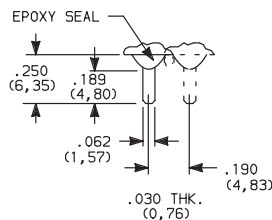

Not available with P, S or R contact materials. Mating quick connector available; order part number 530100000, page J-15.

SPDT & DPDT

W WIRE WRAP

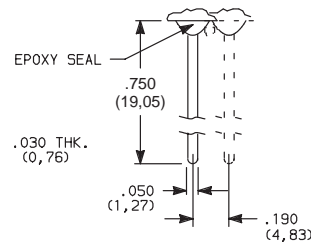

SPDT & DPDT



Third Angle Projection

Dimensions are shown: Inch (mm)
Specifications and dimensions subject to change



1000 Series Miniature Slide Switches

TERMINATIONS

A RIGHT ANGLE, PC THRU-HOLE



1101M2S3ABE2
Horizontal Actuation
SPDT

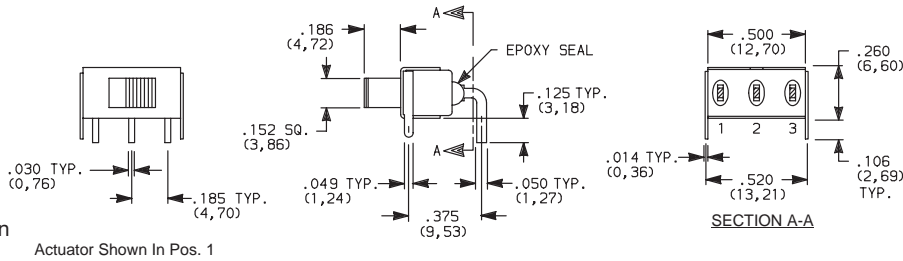

PC MOUNTING

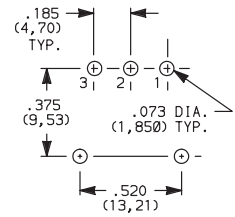

Not available with M1 mounting style, I seal option.
Terminal bend radii and lead-in manufacturing option.

A RIGHT ANGLE, PC THRU-HOLE



1201M2S3ABE2
Horizontal Actuation
DPDT

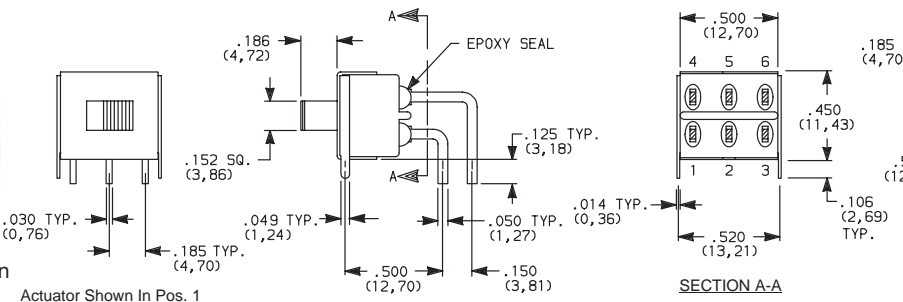

PC MOUNTING

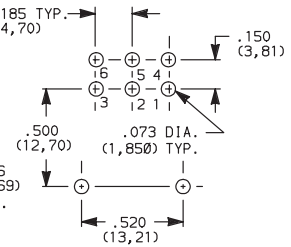

Not available with M1 mounting style, I seal option.
Terminal bend radii and lead-in manufacturing option.

AV2 VERTICAL RIGHT ANGLE, PC THRU-HOLE,
.150" PITCH



1101M2S3AV2BE2
Vertical Actuation
SPDT

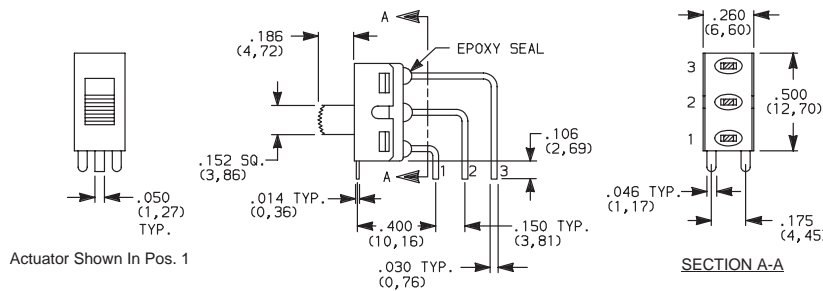

PC MOUNTING

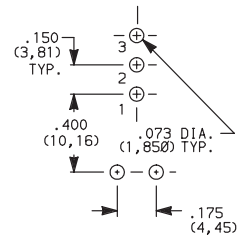

Not available with M1 mounting style, I seal option.
Terminal bend radii and lead-in manufacturing option.



Third Angle
Projection

Dimensions are shown: Inch (mm)
Specifications and dimensions subject to change



Slide

1000 Series Miniature Slide Switches

TERMINATIONS

AV2 VERTICAL RIGHT ANGLE, PC THRU-HOLE,
.150" PITCH

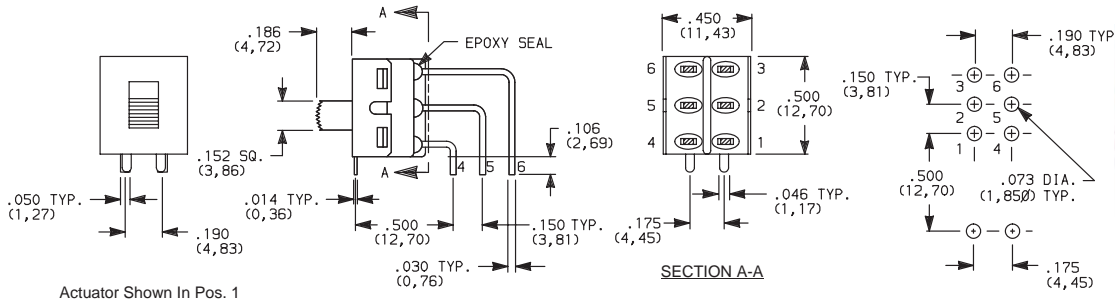

Not available with M1 mounting style, I seal option.
Terminal bend radii and lead-in manufacturing option.

V3, V4 VERTICAL MOUNT,
V-BRACKET

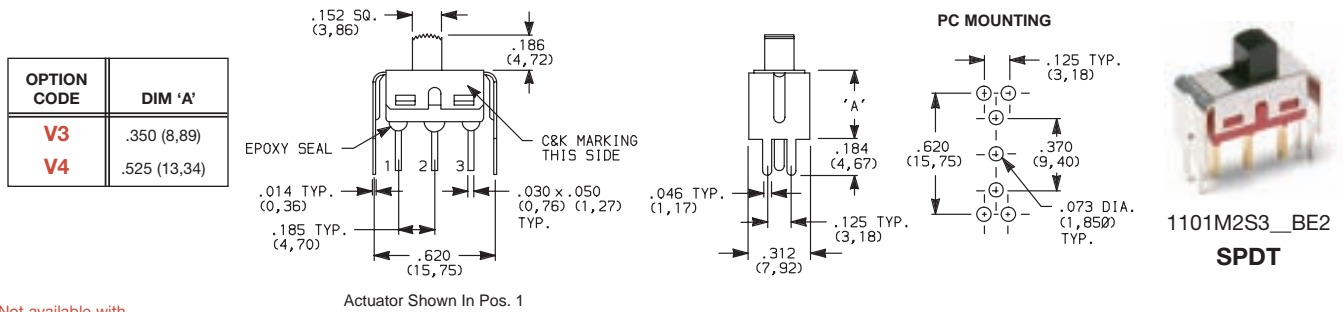

Not available with M1 mounting style and I seal.

V3, V4 VERTICAL MOUNT,
V-BRACKET

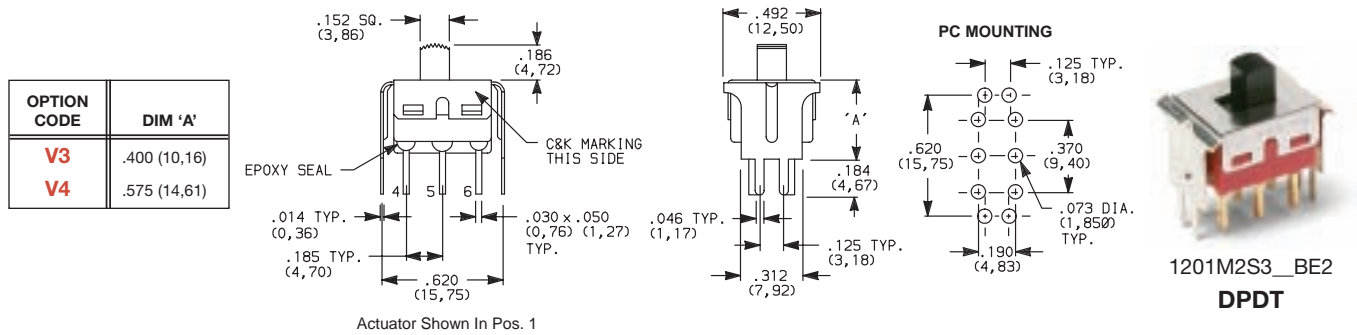

Not available with M1 mounting style and I seal.



Third Angle Projection

Dimensions are shown: Inch (mm)
Specifications and dimensions subject to change



1000 Series Miniature Slide Switches

CONTACT MATERIAL

OPTION CODE	CONTACT MATERIAL	TERMINAL PLATING	RATINGS	
B	GOLD ¹	GOLD ³	LOW LEVEL/ DRY CIRCUIT	0.4 VA MAX. @ 20 V AC OR DC MAX.
P		MATTE-TIN ⁶		
Q	SILVER ^{4,5}	GOLD ³	POWER	6 AMPS @ 120 V AC OR 28 V DC; 3 AMPS @ 250 V AC.
S		MATTE-TIN ⁶		
G	GOLD OVER SILVER ^{2,3}	GOLD ³	LOW LEVEL/DRY CIRCUIT OR POWER	0.4 VA MAX @ 20 V AC OR DC MAX OR 6 AMPS @ 120 V AC OR 0.4 MAX. 28 V DC; 3 AMPS @ 250 V AC.
R		MATTE-TIN ⁶		

* Note: See Technical Data section of this catalog for RoHS compliant and compatible definitions and specifications.

- ¹ CONTACTS & TERMINALS: Copper alloy, with gold plate over nickel plate.
- ² END CONTACTS: Coin silver, with gold plate over nickel plate.
- ³ CENTER CONTACTS & ALL TERMINALS: Copper alloy, with gold plate over nickel plate.
- ⁴ END CONTACTS: Coin silver, silver plated.
- ⁵ CENTER CONTACT & ALL TERMINALS: Copper alloy, silver plated.
- ⁶ TERMINALS: Copper alloy, with matte-tin over nickel plate.

All models   with all options when ordered with G, L, M, Q, S or R contact material.

B contact material standard with all terminations except C, Z, Z3.

Q contact material standard with C, Z, Z3 terminations.

P, S or R contact materials not available with Z, Z3 terminations.

K, L and M options represent Non RoHS tin lead product and are not recommended for new designs. For additional information please contact Customer Service.

NOTE: Any models supplied with Q, B, G, P, S or R contact material are RoHS compliant.

SEAL

E EPOXY SEAL

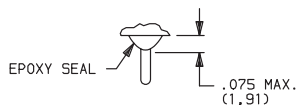

D NO EPOXY SEAL

I EPOXY POTTED BASE

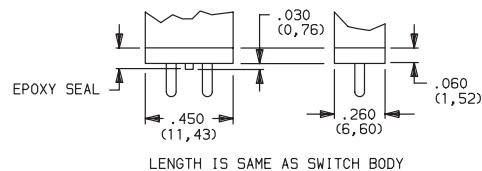

NOTE: Available with C, W, W3, Z, Z3 terminations only.

AVAILABLE HARDWARE

Fits Z3 Termination
female connector



PART NO.

530100000

Available in loose pieces.

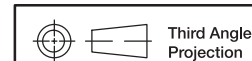

Dimensions are shown: Inch (mm)
Specifications and dimensions subject to change

GS Series Sealed Ultraminiature Slide Switches

Features/Benefits

- Ultraminiature design saves PCB space
- Sealed construction, process compatible with most PCB wash processes
- Available in thru-hole and surface mount
- Long life contact design
- RoHS compliant

Typical Applications

- Computer peripherals & network products
- Test & measurement equipment
- Telephone & cable modems



Specifications

CONTACT RATING: 0.4 VA max. @ 20 V AC or DC max.

MECHANICAL & ELECTRICAL LIFE: 40,000 make-and-break cycles at full load.

CONTACT RESISTANCE: Below 50 mΩ typ. initial @ 2-4 V DC, 100 mA.

INSULATION RESISTANCE: 10⁹ Ω min.

DIELECTRIC STRENGTH: 500 Vrms min. @ sea level.

STORAGE & OPERATING TEMPERATURE: -30°C to 85°C.

SOLDERABILITY: Per MIL-STD-202F method 208D, or EIA RS-186E method 9 (1 hour steam aging).

PACKAGING: Switches available in embossed anti-static tape and reels per EIA 481A. Some models available on embossed anti-static tape and reels per EIA 481-3, consult Customer Service Center.

Materials

HOUSING & BASE: Glass filled 6/6 or 4/6, flame retardant, heat stabilized (UL 94V-0).

ACTUATOR: Polyetherimide PEI (UL 94V-0), with standard internal seal.

SWITCH SUPPORT: Brass, matte-tin plated.

MOVABLE CONTACT: Copper with gold plate over nickel plate.

STATIONARY CONTACTS: Copper alloy, with gold plate over nickel plate.

TERMINALS: Copper alloy, with gold plate over nickel plate.

TERMINAL SEAL: Epoxy. All terminals insert molded.

NOTE: All models are RoHS compliant and compatible with all options.

NOTE: Specifications and materials listed above are for switches with standard options. For information on specific and custom switches, consult Customer Service Center.

How To Order

Complete part numbers for GS Series Sealed Ultraminiature Slide Switches are shown below and on page J-18.

PART NUMBER	SWITCH FUNCTION		SCHEMATIC
	POS. 1	POS. 2	
GS01MCBE	ON	ON	 1 ● 2 (COMM) ● 3 SPDT
Conn. Terms.	2-1	2-3	
GS02MCBE	OFF	ON	 1 ● ● 3 SPST
Conn. Terms.	OPEN	3-1	
GS04MCBE	ON	OFF	 1 ● ● 3 SPST
Conn. Terms.	1-3	OPEN	

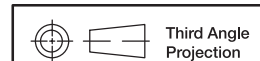
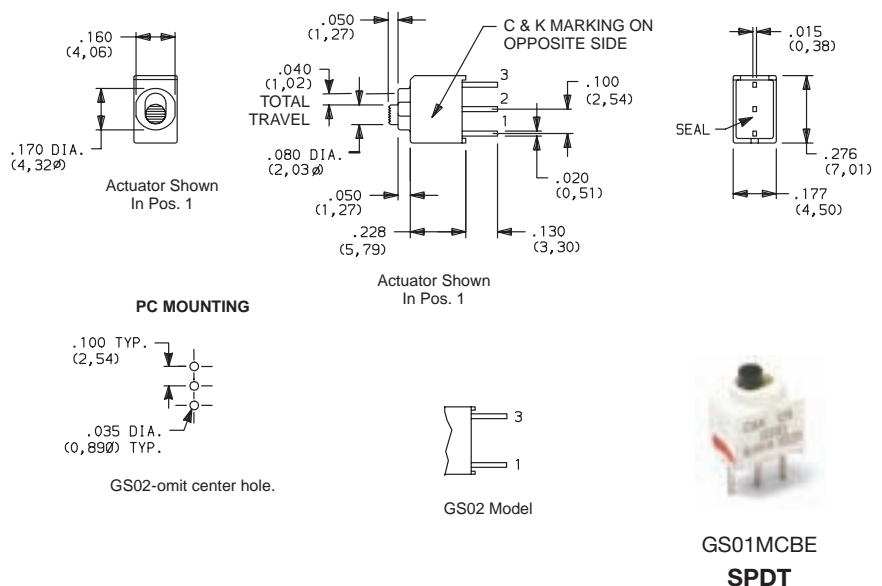

Dimensions are shown: Inch (mm)
Specifications and dimensions subject to change

GS Series Sealed Ultraminiature Slide Switches

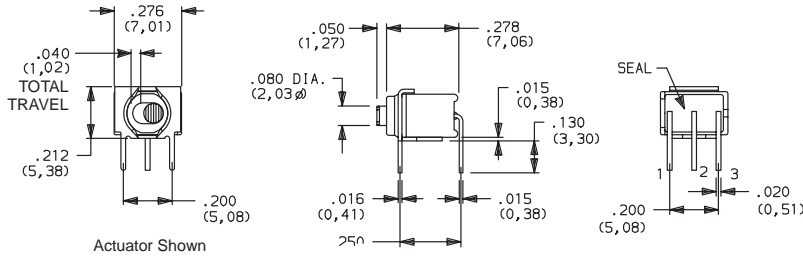

Actuator Shown



GS01MABE
Horizontal Actuation
SPDT

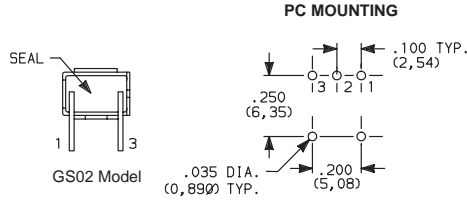

PC MOUNTING

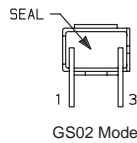

PART NUMBER	SWITCH FUNCTION		SCHEMATIC
	POS.1	POS. 2	
GS01MABE	ON	ON	 SPDT
Conn. Terms.	2-1	2-3	
GS02MABE	OFF	ON	 SPST
Conn. Terms.	OPEN	3-1	
GS04MABE	ON	OFF	 SPST
Conn. Terms.	1-3	OPEN	

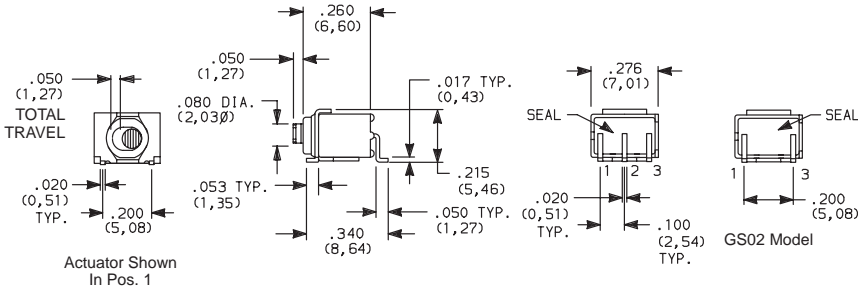

Actuator Shown
In Pos. 1

SMT



GS01MSABE
Horizontal Actuation
SPDT

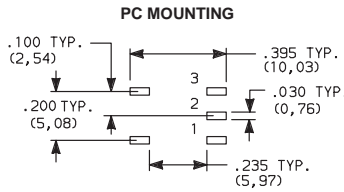

PC MOUNTING

PART NUMBER	SWITCH FUNCTION		SCHEMATIC
	POS.1	POS. 2	
GS01MSABE	ON	ON	 SPDT
Conn. Terms.	2-1	2-3	
GS02MSABE	OFF	ON	 SPST
Conn. Terms.	OPEN	3-1	
GS04MSABE	ON	OFF	 SPST
Conn. Terms.	1-3	OPEN	

TAPE & REEL

FOR PART NUMBERS GS01MSABE, GS02MSABE, GS04MSABE

REEL INFORMATION	
OUTSIDE DIAMETER	13.00 (330,0)
PILOT HOLE	.512 (13,0)
QUANTITY PER REEL	600

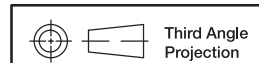
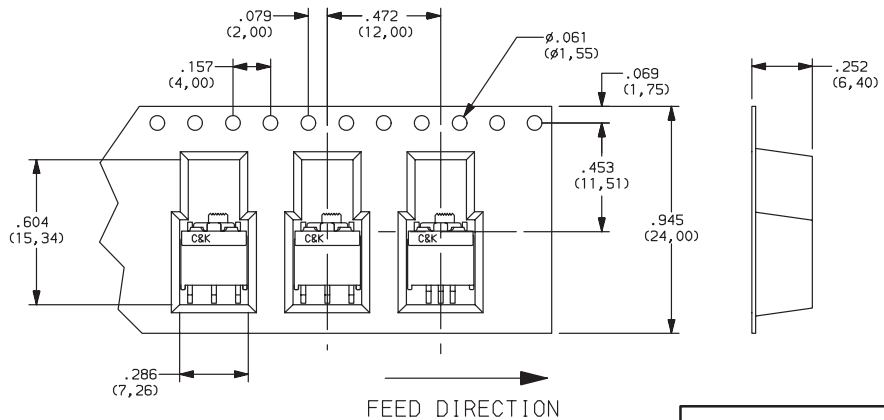

Third Angle
Projection

Dimensions are shown: Inch (mm)
Specifications and dimensions subject to change



L Series Miniature Slide Switches

Features/Benefits

- Positive detent
- Enclosed housing
- Maintained and momentary functions
- PC and panel mounting
- RoHS compliant



Models Available

Typical Applications

- Communications equipment
- Lighting devices



Specifications

CONTACT RATING: Q contact material (LX0X, LX1X Models): 4 AMPS @ 125 V AC or 28 V DC; 2 AMPS @ 250 V AC; 0.5 AMP @ 125 V DC (UL/CSA). See page I-23 for additional ratings.

ELECTRICAL LIFE: 10,000 make-and-break cycles at full load.

CONTACT RESISTANCE: Below 10 m Ω typ. initial @ 2-4 V DC, 100 mA, for both silver and gold plated contacts.

INSULATION RESISTANCE: 10⁹ Ω min.

DIELECTRIC STRENGTH: 1,000 Vrms min. @ sea level.

OPERATING TEMPERATURE: -30°C to +65°C

STORAGE TEMPERATURE: -30°C to +85°C

NOTE: Specifications and materials listed above are for switches with standard options. For information on specific and custom switches, consult Customer Service Center.

Materials

HOUSING: 6/6 nylon (UL94V-2), black.

ACTUATOR: 6/6 nylon (UL94V-2), black. '13' actuator, natural (standard).

CONTACTS: Q contact material: Copper, silver plated. See page J-23 for additional contact materials.

TERMINALS: Q contact material: Copper, silver plated. See page J-23 for additional contact materials.

CONTACT SPRING: Music wire or stainless steel.

TERMINAL SEAL: Epoxy.

NOTE: Any models supplied with Q, B or G contact material are RoHS compliant.

Build-A-Switch

To order, simply select desired option from each category and place in the appropriate box. Available options are shown and described on pages J-20 through J-24. For additional options not shown in catalog, consult Customer Service Center.

<p>Switch Function</p> <p>L202 DPDT</p> <p>L203 DP3T</p> <p>L101 SPST</p> <p>L102 SPDT</p> <p>L103 SP3T</p> <p>L104 SP4T</p> <p>L112 SPDT, mom.</p> <p>L113 SP3T, mom. to one end</p> <p>L123 SP3T, mom. to both ends</p> <p>L201 DPST</p> <p>L204 DP4T</p> <p>L212 DPDT, mom.</p>	<p>Actuator</p> <p>01 .200" high</p> <p>02 .335" high</p> <p>03 .375" high</p> <p>05 .312" high</p> <p>11 .100" high</p> <p>12 Screwdriver slot</p> <p>13 Plunger without cap</p> <p>14 Plunger with .200" dia. cap</p> <p>15 Plunger with .310" dia. cap</p> <p>17 Plunger with .458" dia. cap</p> <p>19 Plunger with .590" dia. cap</p>	<p>Detent</p> <p>1 With detent</p> <p>2 Without detent</p>	<p>Mounting Style</p> <p>MS PC Thru-hole</p> <p>MA Right angle, PC thru-hole</p> <p>ML Right angle, PC thru-hole</p> <p>MV Right angle, PC thru-hole</p> <p>SS Panel with mounting ears</p> <p>TS Panel with integral mounting ears</p>	<p>Terminations</p> <p>02 PC Thru-hole</p> <p>01 Solder lug with notch</p> <p>03 Solder lug with hole</p> <p>04 PC Thru-hole</p> <p>10 PC Thru-hole</p> <p>06 Wire wrap</p> <p>12 PC Thru-hole</p>	<p>Contact Material</p> <p>Q Silver</p> <p>B Gold</p> <p>G Gold over silver</p>	<p>Seal</p> <p>NONE No seal</p> <p>E Epoxy seal</p>	<p>Cap Color</p> <p>2 Black</p> <p>NONE No cap</p>
---	---	---	--	--	---	--	---



Dimensions are shown: Inch (mm)
Specifications and dimensions subject to change



Slide

L Series Miniature Slide Switches

SWITCH AND LOCK FUNCTION



NO. POLES	MODEL NO.	SWITCH FUNCTION	SCHEMATIC	AVAILABLE MOUNTING STYLES
SP	L101	SPST		ML, MS, SS
	L102	SPDT		ML, MS, SS
	L112	SPDT-MOM.		ML, MS, MV, SS
	L103	SP3T		MA, MS, TS
	L113	SP3T-MOM. to one end		MA, MS, TS
	L123	SP3T-MOM. to both ends		MA, MS, TS
	L104	SP4T		MS

NO. POLES	MODEL NO.	SWITCH FUNCTION	SCHEMATIC	AVAILABLE MOUNTING STYLES
DP	L201	DPST		MA, MS, SS
	L202	DPDT		MA, MS, SS
	L212	DPDT-MOM.		MV
	L203	DP3T		MS, TS
	L204	DP4T		MS

NOTE: and MOM. in table indicates momentary action.

All models with all options when ordered with 'G' or 'Q' contact material.

Models with '01' termination option only.

Contacts make on side actuator thrown.

ACTUATOR



ACTUATOR OPTIONS FOR 'MS, MA, ML, SS, & TS' MOUNTING STYLES

01 .200" HIGH 	02 .335" HIGH 	03 .375" HIGH 	05 .312" HIGH 	11 .100" HIGH 	12 SCREWDRIVER SLOT
--------------------------	--------------------------	--------------------------	--------------------------	--------------------------	--------------------------------

NOTE: No actuator color option code is required. Standard actuator color is black, other colors and heights available, consult Customer Service Center. See pages J-20 and J-22 for available mounting styles.

ACTUATOR OPTIONS FOR 'MV' MOUNTING STYLE

13 PLUNGER WITHOUT CAP 	14 PLUNGER WITH CAP 	15 PLUNGER WITH CAP
17 PLUNGER WITH CAP 	19 PLUNGER WITH CAP 	

OPTION CODE	ACTUATOR CAP COLORS
2	BLACK
NONE	01-13, 23 ACTUATORS

Other colors available, consult Customer Service Center.

ACTUATOR CAPS

Caps supplied are not installed standard. To order actuator options '14 thru 29,' select desired cap color from chart and place option code in last box of ordering format. Leave box empty for all other actuator options. Caps may also be ordered separately and user installed, see pages J-23 and J-24. Specify the four digit part number and desired cap color. For switches without caps, order '13' or '23' actuator option. Cap finish: gloss (excluding square cap part number 7982, finish: matte).

SPLASH CAPS

New protective splash caps for PC mounted slide switches are available separately and reusable. They provide splash protection during soldering and cleaning processes. To order specify correct part number, see page J-24.



Dimensions are shown: Inch (mm)
Specifications and dimensions subject to change



L Series Miniature Slide Switches

DETENT

1 WITH DETENT

Standard with all maintained models: L101, L102, L103, L104, L113, L201, L202, L203 and L204.

2 WITHOUT DETENT

Standard with all momentary models: L112, L123, and L212.

MOUNTING STYLE

MS PC THRU-HOLE, 2 POSITION MODELS

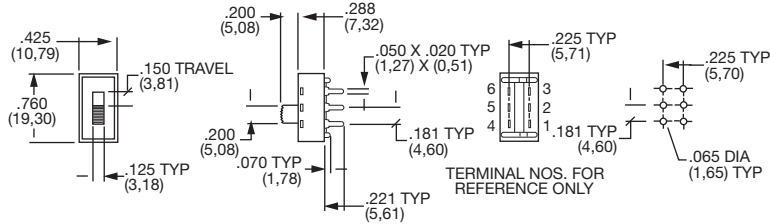

AVAILABLE WITH:

Models: L101, L102, L112, L103, L113 L123, L201, L202, L203, L104 and L204
Terminations: 02, 06, 10 and 12
Actuators: 01, 02, 03, 05, 11 and 12

PC MOUNTING

For mounting information, see TERMINATIONS section, page J-23.
 Splash caps are available separately and reusable, see page J-24.



L203011MS02Q
DP3T

PC THRU-HOLE, 3 POSITION MODELS

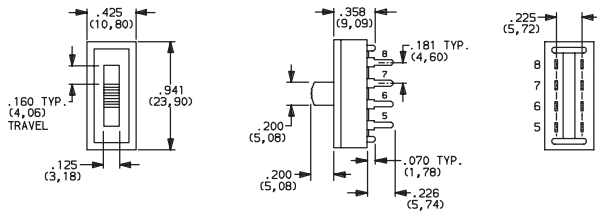

PC THRU HOLE, 4 POSITION MODELS

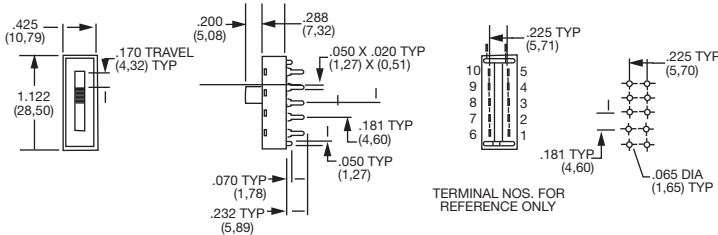

MA RIGHT ANGLE, PC THRU-HOLE

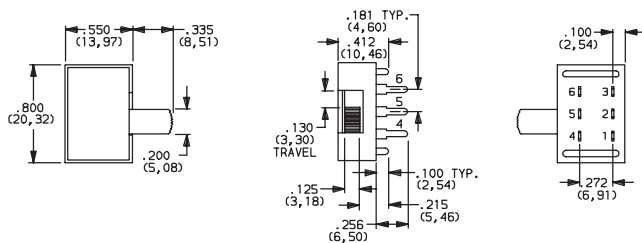

AVAILABLE WITH:

Models: L201, L202, L113 and L123
Terminations: 04
Actuators: 02 and 12

PC MOUNTING

For mounting information, see TERMINATIONS section, page J-23.
 Splash caps are available separately and reusable, see page J-24.



L202021MA04Q
Horizontal Actuation
DPDT

RIGHT ANGLE, PC, SP-3 POSITION MODELS

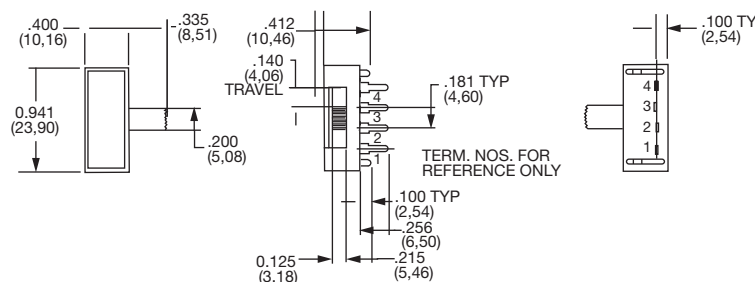

Third Angle Projection
 Dimensions are shown: Inch (mm)
 Specifications and dimensions subject to change



Slide

L Series Miniature Slide Switches

MOUNTING STYLE

ML RIGHT ANGLE, PC THRU-HOLE

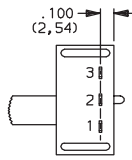
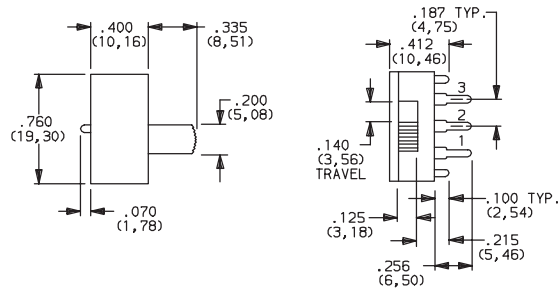

AVAILABLE WITH:

Models: L101, L102, L112
Terminations: 04
Actuators: 01, 02, 05, 11 and 12
PC MOUNTING

For mounting information, see
 TERMINATIONS section, page J-23.
 Splash caps are available separately
 and reusable, see page J-24.



L102021ML04Q
Horizontal Actuation
SPDT

MV RIGHT ANGLE, PC THRU-HOLE

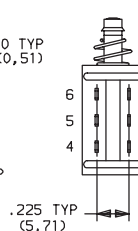
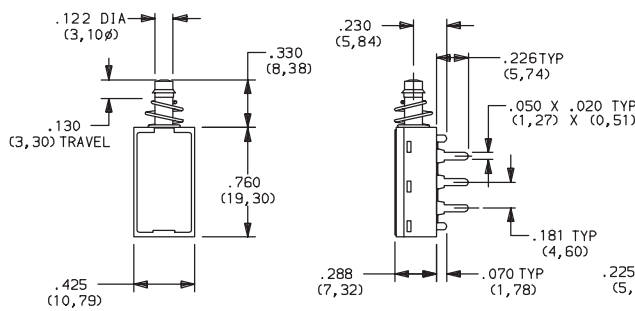

AVAILABLE WITH:

Models: L112 and L212
Terminations: 02, 06, 10 and 12
Actuators: 13 thru 19
PC MOUNTING

PC MOUNTING

For mounting information, see
 TERMINATIONS section, page J-23.
 Splash caps are available separately
 and reusable, see page J-24.



L212132MV02Q
DPDT

Slide

SS PANEL WITH MOUNTING EARS



L202011SS03Q
DPDT

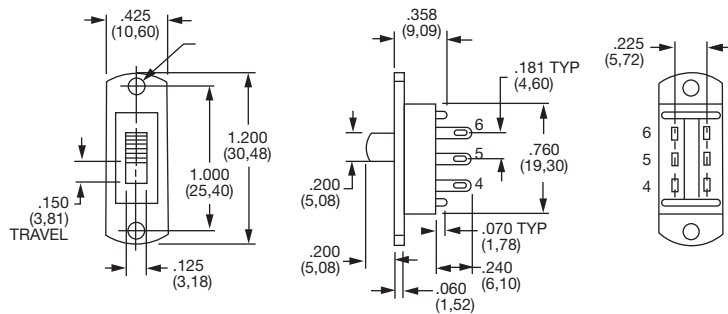

PANEL MOUNTING

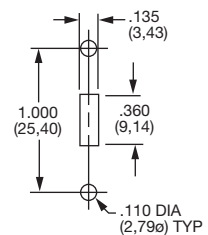

AVAILABLE WITH:

Models: L101, L102, L112, L201 and L202
Terminations: 01, 02, 03, 06, 10, 12
Actuators: 01, 02, 03, 05, 11 and 12

TS PANEL WITH INTEGRAL MOUNTING EARS



L203011TS03Q
DP3T

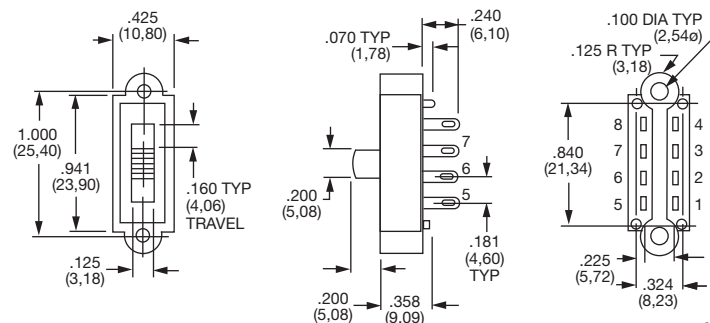

PANEL MOUNTING

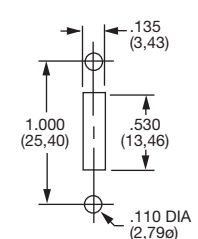

AVAILABLE WITH:

Models: L103, L113, L123 and L203
Terminations: 01, 02, 03, 06, 10, 12
Actuators: 01, 02, 03, 05, 11 and 12



Third Angle
Projection
 Dimensions are shown: Inch (mm)
 Specifications and dimensions subject to change



L Series Miniature Slide Switches

TERMINATIONS

'MS, MV, SS & TS' Mounting Styles Only

02 PC THRU-HOLE

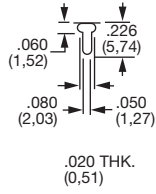

01 SOLDER LUG WITH NOTCH

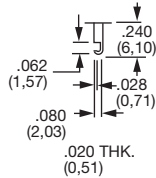

'01' terminations only.

03 SOLDER LUG WITH HOLE

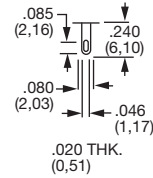

10 PC THRU-HOLE

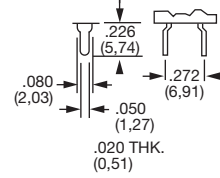

12 PC THRU-HOLE

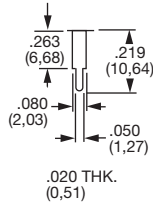

06 WIRE WRAP

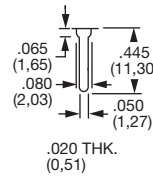

'MA & ML' Mounting Styles Only

04 PC THRU-HOLE

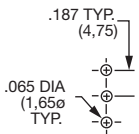
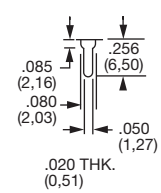

All models with '04' terminations and 'ML' mounting style.

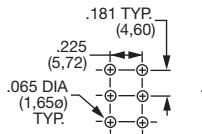

All 2 position models, except '04' terminations.

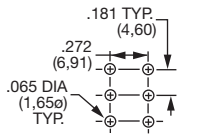

All 2 position models with '04' terminations and 'MA' mounting style.

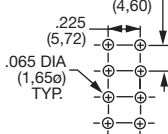

All 2 position models with '04' terminations and 'MA' mounting style.

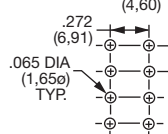

All 3 position models, except '04' terminations.

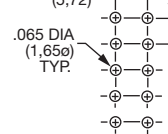

All 3 position models, with '10' terminations.

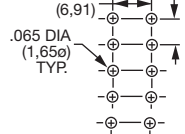

All 4 position models, with '10' terminations.

CONTACT MATERIAL

OPTION CODE	CONTACT MATERIAL	RATINGS	
Q	SILVER ²	LOW LEVEL/DRY CIRCUIT	LX0X, LX1X MODELS: 4 AMPS @ 125 V AC or 28 V DC; 2 AMPS @ 250 V AC; 0.5 AMP @ 125 V DC (UL/CSA). LX6X MODELS: 4 AMPS @ 125 V AC or 28 V DC; 2 AMPS @ 250 V AC (UL/CSA).
B	GOLD ¹	POWER	0.4 VA MAX. @20 V AC OR DC max.
G	GOLD OVER SILVER ³	LOW LEVEL/DRY CIRCUIT OR POWER	LX0X, LX1X MODELS: 0.4 VA MAX. @ 20 V AC or DC MAX. or 4 AMPS @ 125 V AC or 28 V DC; 2 AMPS @ 250 V AC; 0.5 AMP @ 125 V DC (UL/CSA). LX6X MODELS: 0.4 VA MAX. @ 20 V AC or DC MAX. or 4 AMPS @ 125 V AC or 28 V DC; 2 AMPS @ 250 V AC (UL/CSA).

* Note: See Technical Data section of this catalog for RoHS compliant and compatible definitions and specifications.

¹ CONTACTS & TERMINALS: Copper, with gold plate over nickel plate.

² CONTACTS & TERMINALS: Copper, silver plated (standard with all termination options).

³ CONTACTS & TERMINALS: Copper, with gold plate over nickel plate over silver plate.

NOTE: Any models supplied with Q, B or G contact material are RoHS compliant.

All models with all options (except '01' termination) when ordered with 'G' or 'Q' contact material.

Models with '01' termination option only.

NOTE: 'G' contact material is equivalent to both 'B' and 'Q' contact materials.

SEAL

NONE NO SEAL

E EPOXY SEAL

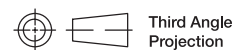
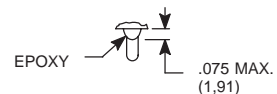

Dimensions are shown: Inch (mm)
Specifications and dimensions subject to change

L Series Miniature Slide Switches

AVAILABLE HARDWARE

Cap
Compatible with 13-19 actuators

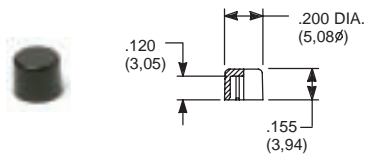

PART NO.

708902000 BLACK
708903000 RED

Material: Nylon
Finish: Gloss

Cap
Compatible with 13-19 actuators

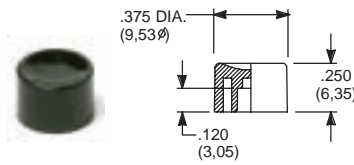

PART NO.

752702000 BLACK
752703000 RED

Material: Nylon
Finish: Gloss

Cap
Compatible with 13-19 actuators

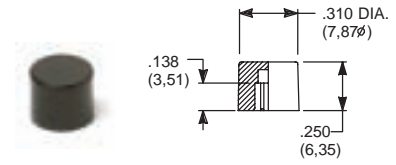

PART NO.

801802000 BLACK
801803000 RED

Material: Nylon
Finish: Gloss

Cap
Compatible with 13-19 actuators

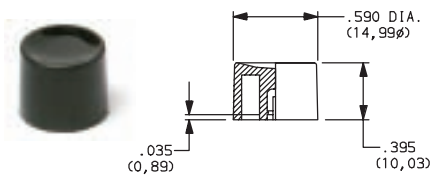

PART NO.

894002000 BLACK
894003000 RED

Material: Nylon
Finish: Gloss

Cap
Compatible with 13-19 actuators

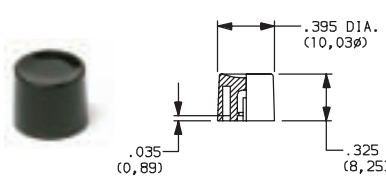

PART NO.

894102000 BLACK
894103000 RED

Material: Nylon
Finish: Gloss

Cap
Compatible with 13-19 actuators

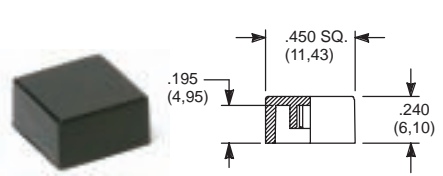

PART NO.

484602000 BLACK
484603000 RED

Material: Nylon
Finish: Gloss

PART NO.

798202263 BLACK
798203000 RED

Material: Nylon
Finish: Matte

Slide

Cap
Compatible with 01-05 actuators

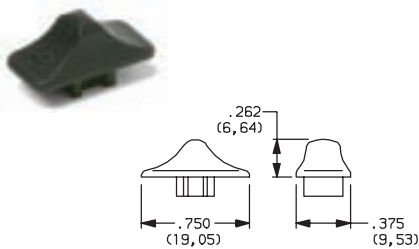

PART NO.

120100602 BLACK

Material: Nylon
Finish: Matte

Splash Cap



Fits 'MS' mounting style,
LXX1 & LXX2 models only.

PART
NO.

120100200

Material: Nylon

Splash Cap



Fits 'MV' mounting style,
LX1X models only.

PART NO.

120100300

Material: Nylon

Splash Cap



Fits 'MA' mounting style,
LXX3 models only.

PART NO.

120100400

Material: Nylon

NOTE: Other colors available,
consult Customer Service Center.



Third Angle
Projection

Dimensions are shown: Inch (mm)
Specifications and dimensions subject to change

C&K

LP Series Miniature Snap-in Slide Switches

Features/Benefits

- 6 to 11 AMPS available
- Easy assembly—Snap-in mounting
- Contamination resistant—extended actuator
- Positive detent
- RoHS compliant

Typical Applications

- Small appliances
- Outdoor appliances
- Portable tools



Models Available

Specifications

CONTACT RATING: Q contact material (LP0X, LP2X Models: 6 AMPS @ 125 V AC or 28 V DC; 3 AMPS @ 250 V AC (UL/CSA). (LP7X, LP8X Models): 11 AMPS @ 125/250 V AC (UL/CSA). See page I-27 for additional ratings.

ELECTRICAL LIFE: 10,000 make-and-break cycles at full load.

INSULATION RESISTANCE: $10^9 \Omega$ min.

DIELECTRIC STRENGTH: 1,000 Vrms min. @ sea level.

CONTACT RESISTANCE: Below 10 m Ω typ. initial @ 2-4 V DC, 100 mA, for both silver and gold plated contacts.

OPERATING TEMPERATURE: -30°C to +65°C

STORAGE TEMPERATURE: -30°C to +85°C

NOTE: Any models supplied with Q, B or G contact material are RoHS compliant.

NOTE: Specifications and materials listed above are for switches with standard options. For information on specific and custom switches, consult Customer Service Center.

Materials

HOUSING: 6/6 nylon (UL94V-2), black.

ACTUATOR: Glass filled acetal, UV and petroleum resistant, black.

CONTACTS: Q contact material: Copper, silver plated. See page I-27 for additional contact materials.

TERMINALS: Q contact material: Copper, silver plated. See page I-27 for additional contact materials.

CONTACT SPRING: Music wire or stainless steel.

TERMINAL SEAL: Epoxy.

Build-A-Switch

To order, simply select desired option from each category and place in the appropriate box. Available options are shown and described on pages J-26 and J-27. For additional options not shown in catalog, consult Customer Service Center.

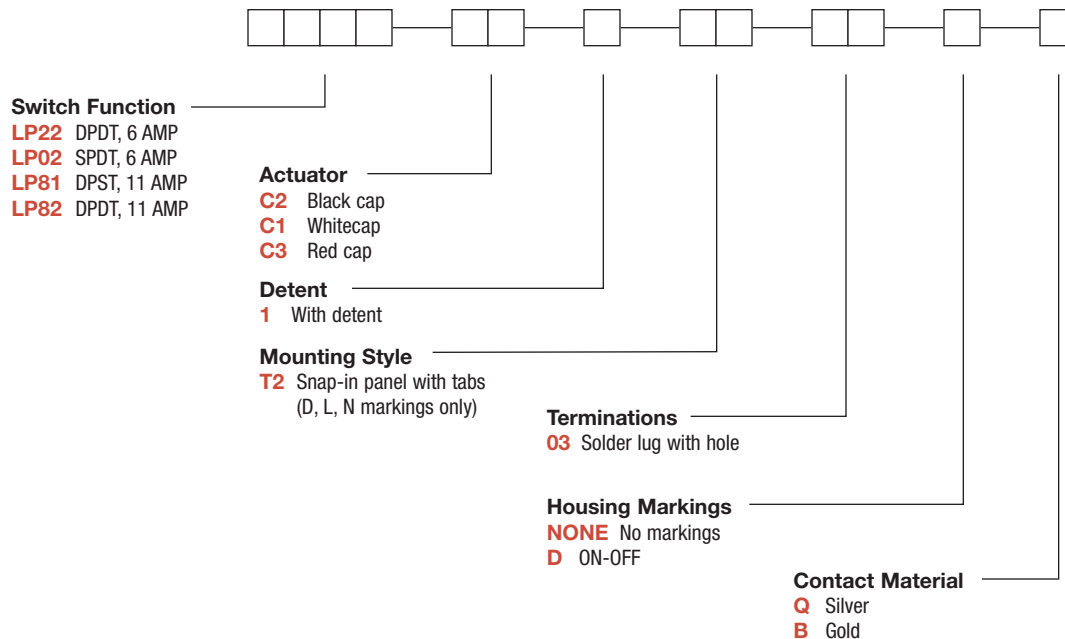

Third Angle Projection
Dimensions are shown: Inch (mm)
Specifications and dimensions subject to change



Slide

LP Series Miniature Snap-in Slide Switches

SWITCH FUNCTION

NO. POLES	MODEL NO.	AMP RATING*	SWITCH FUNCTION	SCHEMATIC
SP	LP02	6	SPDT	

NO. POLES	MODEL NO.	AMP RATING*	SWITCH FUNCTION	SCHEMATIC
DP	LP22	6	DPDT	
	LP81	11	DPST	
	LP82	11	DPDT	

All models with all options when ordered with 'Q' contact material.

Contacts make on side actuator thrown.

* For complete contact ratings, see CONTACT MATERIALS Section, page J-26.

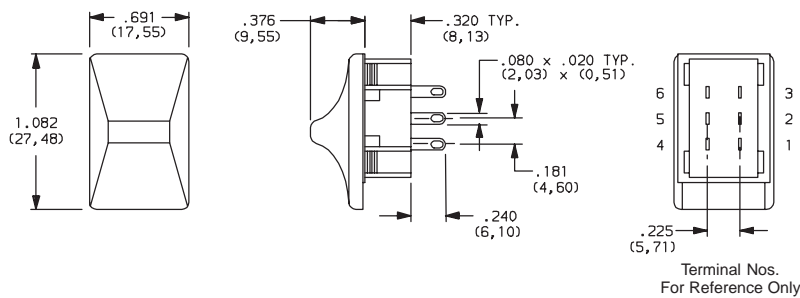

Part number shown: LP22C21S203Q

ACTUATOR

C1; C2; C3

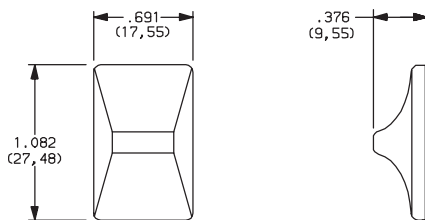

OPTION CODE2	ACTUATOR CAP COLOR
C2	BLACK
C1	WHITE
C3	RED

NOTE: Actuator finish: gloss. Other colors available, consult Customer Service Center.

DETENT

1 WITH DETENT

MOUNTING STYLE

T2 SNAP-IN PANEL WITH TABS



Mounting style T2 suitable for markings. See HOUSING MARKINGS options.

PANEL THICKNESS	DIM 'A'
.030-.045 (0,76) (1,14)	.578 (14,68)
.046-.059 (1,17) (1,50)	.585 (14,86)
.060-.089 (1,52) (2,26)	.598 (15,19)
.090-.120 (2,29) (3,05)	.610 (15,49)

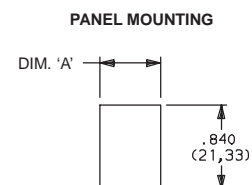

Dimensions are shown: Inch (mm)
 Specifications and dimensions subject to change



Slide

LP Series Miniature Snap-in Slide Switches

TERMINATIONS

03 SOLDER LUG WITH HOLE

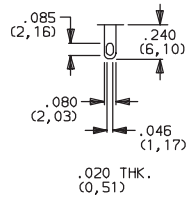

HOUSING MARKINGS

NONE NO MARKINGS

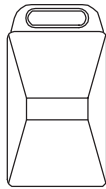

D ON-OFF

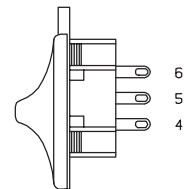
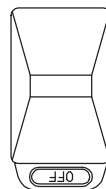
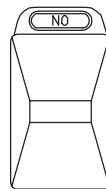

NOTE: Housing markings are available with 'T2' mounting style only. The marking color on all housings with marking options 'D' is white, standard. Other marking colors are available, consult Customer Service Center.

Orientation of actuator and terminals.

CONTACT MATERIAL

OPTION CODE	CONTACT MATERIAL	RATINGS	
Q	SILVER ²	POWER	LP0X, LP2X MODELS: 6 AMPS @ 125 V AC or 28 V DC; 3 AMPS @ 250 V AC (UL/CSA). LP7X, LP8X MODELS: 11 AMPS @ 125/250 V AC (UL/CSA).
B	GOLD ¹	LOW LEVEL/DRY CIRCUIT	0.4 VA MAX. @20 V AC OR DC MAX.

* Note: See Technical Data section of this catalog for RoHS compliant and compatible definitions and specifications.

¹ CONTACTS & TERMINALS: Copper, with gold plate over nickel plate.

² CONTACTS & TERMINALS: Copper, silver plated (standard with all termination options).

³ CONTACTS & TERMINALS: Copper, with gold plate over nickel plate over silver plate.

NOTE: Any models supplied with Q or B contact material are RoHS compliant.

All models with all when ordered with 'Q' contact material.

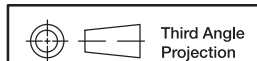

Dimensions are shown: Inch (mm)
Specifications and dimensions subject to change



Slide

S Series Slide Switches



Features/Benefits

- 6 to 15 AMPS
- Enclosed housing
- PC and Snap-in panel mounting
- Reversing option
- RoHS compliant

Typical Applications

- Portable tools
- Small appliances
- Floor care products



Specifications

CONTACT RATING: Q contact material (S1XX, S2XX Models): 6 AMPS @ 125 V AC; 6 AMPS @ 250 V AC; 1 AMP @ 125 V DC (UL/CSA). (S5XX, S6XX Models): 12 AMPS @ 125 V AC; 6 AMPS @ 250 V AC; 1 AMP @ 125 V DC (UL/CSA). (S7XX, S8XX Models): 15 AMPS @ 125 V AC; 6 AMPS @ 250 V AC (UL/CSA). See page J-31 for additional ratings.

ELECTRICAL LIFE: 10,000 make-and-break cycles at full load.

CONTACT RESISTANCE: Below 10 m Ω typ. initial @ 2-4 V DC, 100 mA, for both silver and gold plated contacts.

INSULATION RESISTANCE: 10⁹ Ω min.

DIELECTRIC STRENGTH: 1,000 Vrms min. @ sea level.

OPERATING TEMPERATURE: -30°C to +65°C

STORAGE TEMPERATURE: -30°C to +85°C

Materials

HOUSING: 6/6 nylon (UL94V-2), black.

TOP PLATE: 6/6 nylon (UL94V-2), black.

ACTUATOR: 6/6 nylon (UL94V-2), black (standard).

CONTACTS: Q contact material: Copper, silver plated. See page J-31 for additional contact materials.

TERMINALS: Q contact material: Copper, silver plated. See page J-31 for additional contact materials.

CONTACT SPRING: Music wire or stainless steel.

TERMINAL SEAL: Epoxy.

NOTE: Any models supplied with Q, B or G contact material are RoHS compliant.

NOTE: Specifications and materials listed above are for switches with standard options. For information on specific and custom switches, consult Customer Service Center.

Build-A-Switch

To order, simply select desired option from each category and place in the appropriate box. Available options are shown and described on pages J-29 through J-32. For additional options not shown in catalog, consult Customer Service Center.

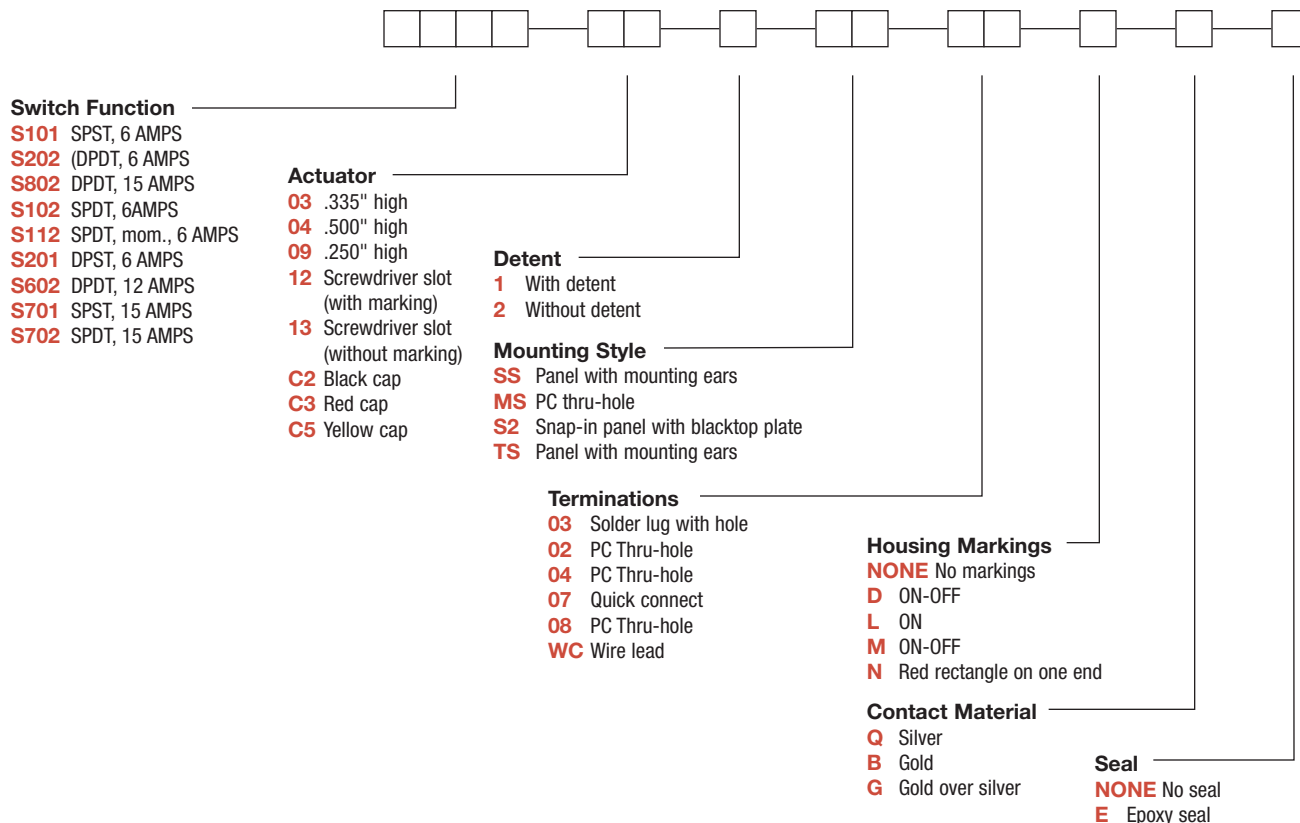

Dimensions are shown: Inch (mm)
Specifications and dimensions subject to change

S Series Slide Switches

SWITCH FUNCTION



NO. POLES	MODEL NO.	AMP RATING	SWITCH FUNCTION	SCHEMATIC	AVAILABLE MOUNTING STYLES
SP	S101	6	SPST		SS
	S102	6	SPDT		MS,SS
	S112	6	SPDT-MOM.		MS,SS
	S701	15	SPST		S1,S2,S3,ST
	S702	15	SPDT		S1,S2,S3,ST

SPST

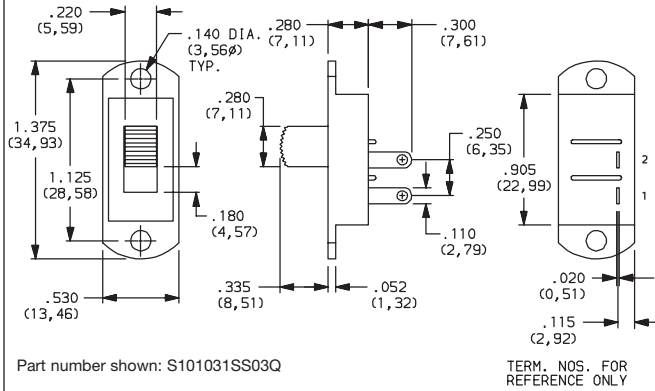

NO. POLES	MODEL NO.	AMP RATING	SWITCH FUNCTION	SCHEMATIC	AVAILABLE MOUNTING STYLES
DP	S201	6	DPST		MS,SS,TS
	S202	6	DPDT		MS,SS,TS
	S602	12	DPDT		MS,SS,TS
	S802	15	DPDT		S1,S2,S3,ST

DPDT

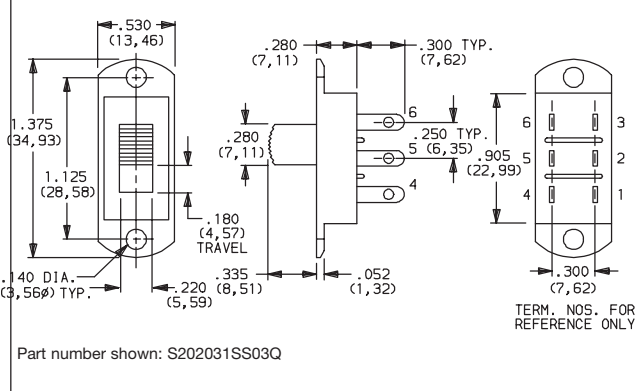

NOTE: and MOM. in table indicates momentary action.

All models with all options when ordered with 'G' or 'Q' contact material.

Contacts make on side actuator thrown.

ACTUATOR



03 .335" HIGH

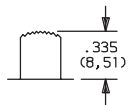

04 .500" HIGH

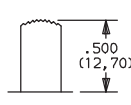

09 .250" HIGH

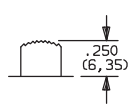

12 SCREWDRIVER SLOT (WITH MARKING)

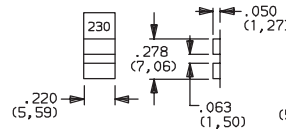

13 SCREWDRIVER SLOT (WITHOUT MARKING)

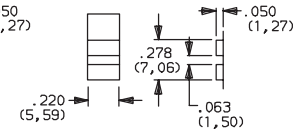

NOTE: Standard actuator color is black, other colors available, consult Customer Service Center. Alternate heights are available with '03, 04 and 09' actuators, consult Customer Service Center. Models with S2 mounting style, subtract .090 (2, 29). Actuators '12' and '13' are available with DPST and DPDT models only.

White 115-230 markings (std.).

Without markings.

C2; C3; C5 SNAP-ON CAP

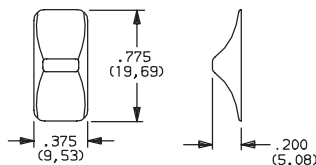

Available with S2 mounting style only.

OPTION CODE2	C1-CT CAP COLOR
C2	BLACK
C3	RED
C5	YELLOW

NOTE: Actuator finish: matte. If no color is specified, black will be supplied. Colored actuator caps may also be ordered separately and user installed, see page J-31.



Dimensions are shown: Inch (mm)
Specifications and dimensions subject to change



Slide

S Series Slide Switches

DETENT

- 1 WITH DETENT**
Standard with all maintained models: S101, S102, S201, S202, S602, S701, S702, and S802.
- 2 WITHOUT DETENT**
Standard with all momentary models: S112.

MOUNTING STYLE

SS PANEL WITH MOUNTING EARS

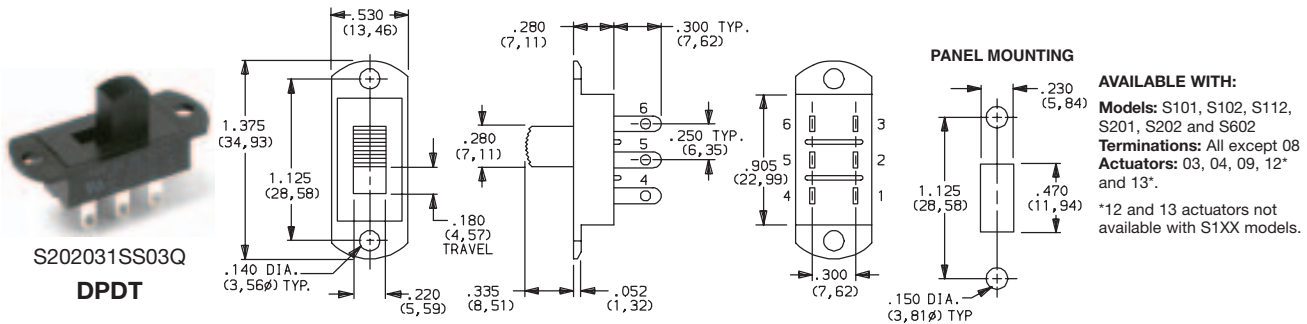

MS PC THRU-HOLE

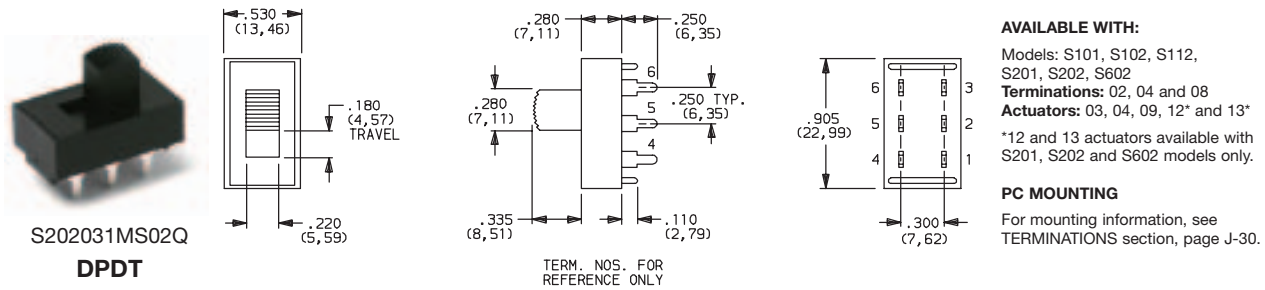

S2 SNAP-IN PANEL

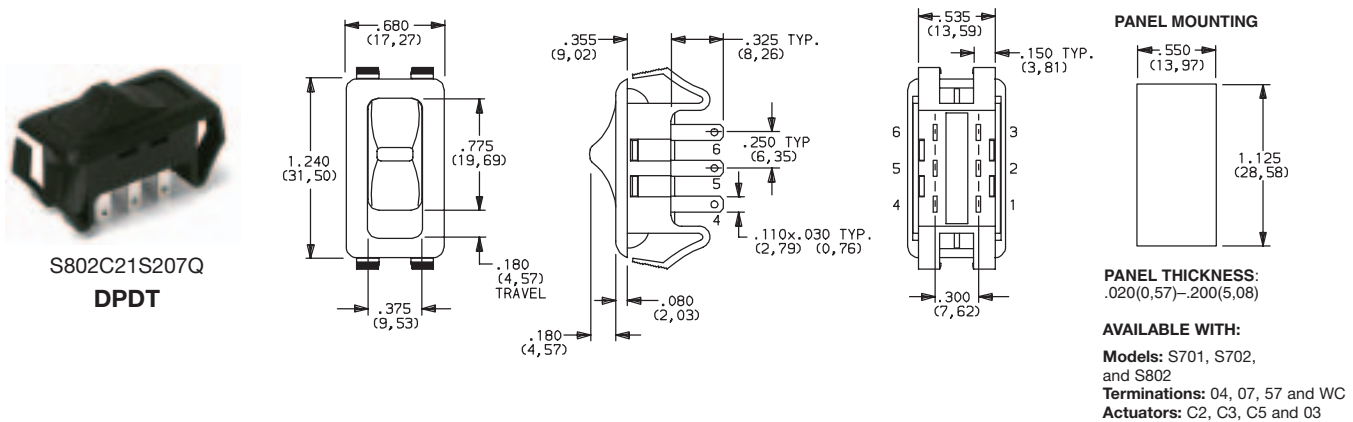

Dimensions are shown: Inch (mm)
Specifications and dimensions subject to change



Slide

S Series Slide Switches

MOUNTING STYLE

TS PANEL WITH MOUNTING EARS

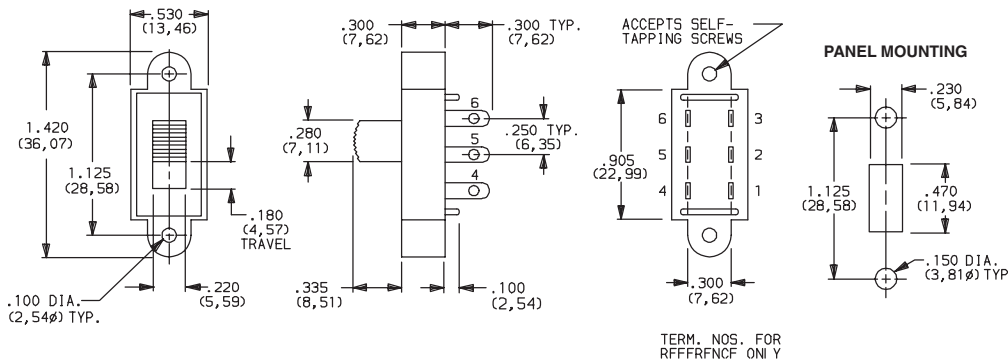

S202031TS03Q
DPDT

AVAILABLE WITH:
Models: S201, S202, and S602
Terminations: All
Actuators: 03, 04 and 12.



Slide

TERMINATIONS

03 SOLDER LUG WITH HOLE

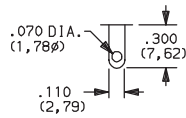

02 PC THRU-HOLE

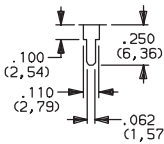

Recommended with 'MS' mounting style only.

04 PC THRU-HOLE

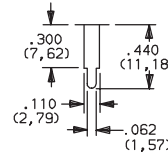

Recommended with double pole models only.

07 QUICK CONNECT

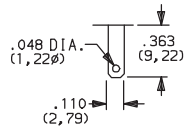

08 PC THRU-HOLE

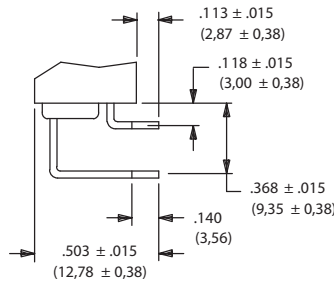

MS mounting style only.

WC WIRE LEAD

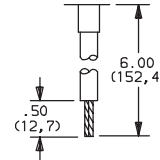

18 AWG wire for S1XX and S2XX models. 16 AWG wire for all other models. Black wire standard, other colors and lengths available, consult Customer Service Center. UL style 1015.

PC MOUNTING

02 & 04 terminations

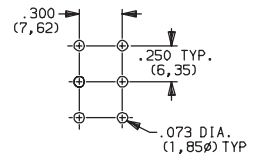

08 terminations with MS mounting style.

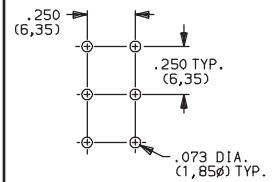

NOTE: All terminals on S1XX, S2XX and S6XX models are .020 (0,51) thick; all terminals on S7XX and S8XX models are .031 (0,79) thick.

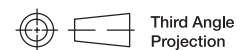

Dimensions are shown: Inch (mm)
Specifications and dimensions subject to change



S Series Slide Switches

TOP PLATE MARKINGS

NONE NO MARKINGS **D** ON-OFF **L** ON **M** ON-OFF **N** RED RECTANGLE ON ONE END

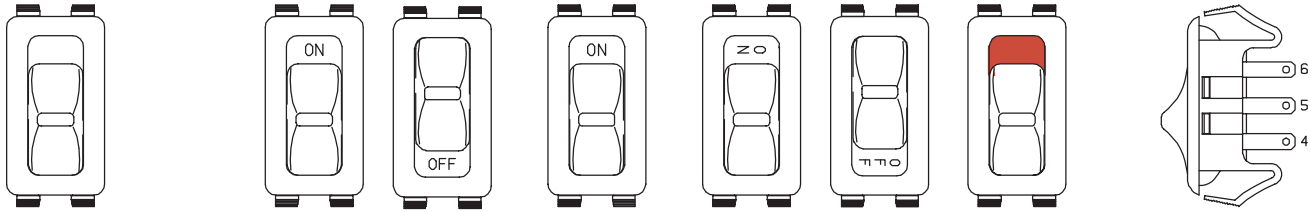

NOTE: Top plate markings are available with 'S2' mounting style only. The marking color on all top plates with marking options 'D, L and M' is white, standard. (except white top plates: marking color is black, standard). The marking color on all top plates with 'N' marking option is red, standard. Other marking colors are available, consult Customer Service Center.

Note: Orientation of actuator markings and terminals.

Slide

CONTACT MATERIAL

OPTION CODE	CONTACT MATERIAL	RATINGS	
Q	SILVER ²	POWER	S1XX, S2XX MODELS: 6 AMPS @ 125 V AC; 6 AMPS @ 250 V AC; 1 AMP @ 125 V DC (UL/CSA). S6XX MODELS: 12 AMPS @ 125 V AC; 6 AMPS @ 250 V AC; 1 AMP @ 125 V DC (UL/CSA). S7XX, S8XX MODELS: 15 AMPS @ 125 V AC; 6 AMPS @ 250 V AC (UL/CSA).
B	GOLD ¹	LOW LEVEL/DRY CIRCUIT	0.4 VA MAX. @20 V AC OR DC max.
G	GOLD OVER SILVER ³	LOW LEVEL/DRY CIRCUIT OR POWER	S1XX, S2XX MODELS: 0.4 VA MAX. @ 20 V AC OR DC MAX. OR 6 AMPS @ 125 V AC; 6 AMPS @ 250 V AC; 1 AMP @ 125 V DC (UL/CSA). S6XX MODELS: 0.4 VA MAX. @ 20 V AC OR DC MAX. OR 12 AMPS @ 125 V AC; 6 AMPS @ 250 V AC; 1 AMP @ 125 V DC (UL/CSA). S7XX, S8XX MODELS: 0.4 VA MAX. @ 20 V AC OR DC MAX. OR 15 AMPS @ 125 V AC; 6 AMPS @ 250 V AC (UL/CSA).

* Note: See Technical Data section of this catalog for RoHS compliant and compatible definitions and specifications.

- ¹ CONTACTS & TERMINALS: Copper, with gold plate over nickel plate.
- ² CONTACTS & TERMINALS: Copper, silver plated (standard with all termination options).
- ³ CONTACTS & TERMINALS: Copper, with gold plate over nickel plate over silver plate.

NOTE: Any models supplied with Q, B or G contact material are RoHS compliant.

All models with all options when ordered with 'G' or 'Q' contact material.

NOTE: 'G' contact material is equivalent to both 'B' and 'Q' contact materials.

SEAL

NONE NO SEAL

E EPOXY SEAL

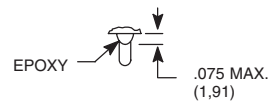

AVAILABLE HARDWARE

Cap, C2; C3 actuators

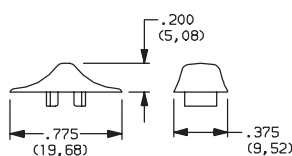

PART NO.
121160100 WHITE
121160200 BLACK
121160300 RED

Material: 6/6 Nylon
 Finish: Matte

Cap, 03 actuator

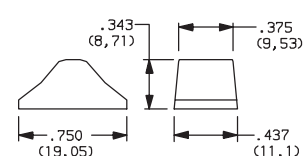

PART NO.
121000101 WHITE
121000102 BLACK
121000103 RED

Material: 6/6 Nylon
 Finish: Gloss

NOTE: Other cap colors available, consult Customer Service Center.

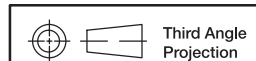

Dimensions are shown: Inch (mm)
 Specifications and dimensions subject to change



V Series Power & Line Voltage Select Slide Switches

Features/Benefits

- Ratings up to 10 AMPS
- Snap-in panel and PC mounting
- Actuators with screwdriver slot
- Quick connect terminals available
- RoHS compliant

Typical Applications

- Appliances



Models Available

Specifications

CONTACT RATING: 10.1 AMPS @ 125 V AC; 4 AMPS @ 28 V DC;
5 AMPS @ 250 V AC (UL/CSA). 2.0 (0.5) AMPS @ 250 V AC,
T85 (VDE).

ELECTRICAL LIFE: 10,000 make-and-break cycles at full load.

CONTACT RESISTANCE: Below 10 m Ω typ. initial
@ 2-4 V DC, 100 mA.

INSULATION RESISTANCE: 10⁹ Ω min.

DIELECTRIC STRENGTH: 1,000 Vrms min. @ sea level.

OPERATING TEMPERATURE: -30°C to +85°C.

NOTE: Any models supplied with Q, B or G contact material are RoHS compliant.

NOTE: Specifications and materials listed above are for switches with standard options.
For information on specific and custom switches, consult Customer Service Center.

Materials

HOUSING: 6/6 nylon (UL94V-2), black.

TOP PLATE: 6/6 nylon (UL94V-2), black.

ACTUATOR: Glass filled polyester (UL94V-0), '01 and 02' styles,
black (standard); '12, 13 and 14' styles, red (standard).

CONTACTS: Copper, silver plated.

TERMINALS: Copper, silver plated.

CONTACT SPRING: Music wire or stainless steel.

TERMINAL SEAL: Epoxy.

Build-A-Switch

To order, simply select desired option from each category and place in the appropriate box. Available options are shown and described on pages J-34 through J-36. For additional options not shown in catalog, consult Customer Service Center.

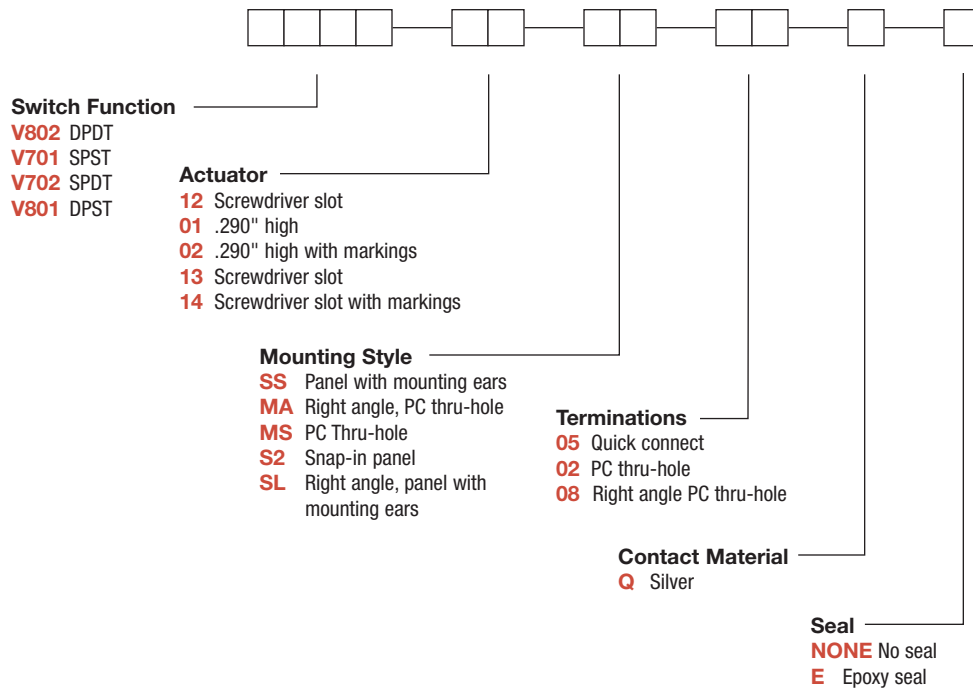

Dimensions are shown: Inch (mm)
Specifications and dimensions subject to change



Slide

V Series Power & Line Voltage Select Slide Switches

SWITCH FUNCTION

NO. POLES	MODEL NO.	SWITCH FUNCTION	SCHEMATIC	AVAILABLE MOUNTING STYLES
SP	V701	SPST		ALL
	V702	SPDT		ALL

All models with all options.
Contacts make on side actuator thrown.

NO. POLES	MODEL NO.	SWITCH FUNCTION	SCHEMATIC	AVAILABLE MOUNTING STYLES
DP	V801	DPST		ALL
	V802	DPDT		ALL

ACTUATOR

12 SCREWDRIVER SLOT WITH MARKING

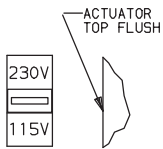

Actuator color is red with 115V-230V markings (std.).

01 .290" HIGH

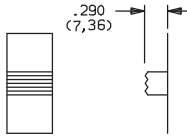

Actuator color is black.

02 .290" HIGH WITH MARKINGS

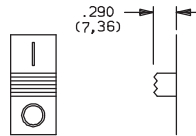

markings are reversed on V702 and V802 models. Actuator color is black with white markings (std.).

13 SCREWDRIVER SLOT NO MARKING

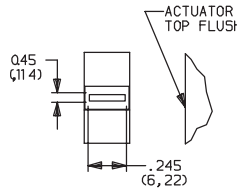

Actuator color is red.

14 SCREWDRIVER SLOT WITH MARKINGS

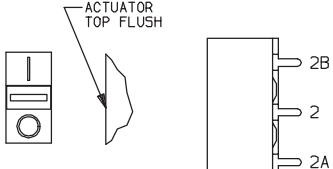

Markings are reversed on V702 and V802 models. Actuator color is red with white markings (std.). **Note:** Orientation of actuator markings and terminals.

MOUNTING STYLE

SS PANEL WITH MOUNTING EARS



V80212SS05Q
DPDT

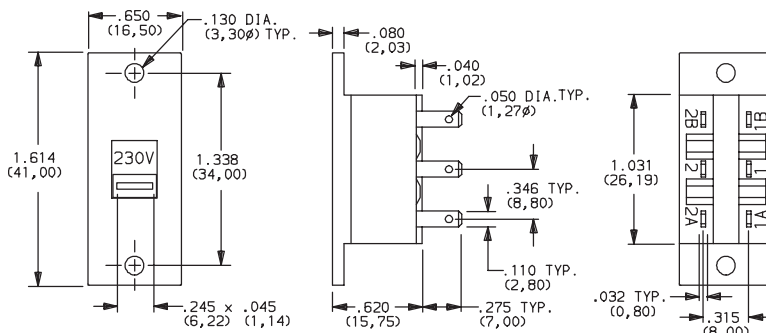

PANEL MOUNTING

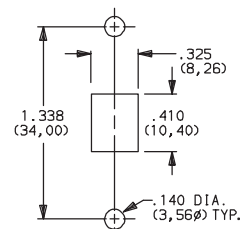

AVAILABLE WITH:
Models: All.
Terminations: 02 and 05

MA RIGHT ANGLE, PC THRU-HOLE



V80212MA08Q
Horizontal Actuation
DPDT

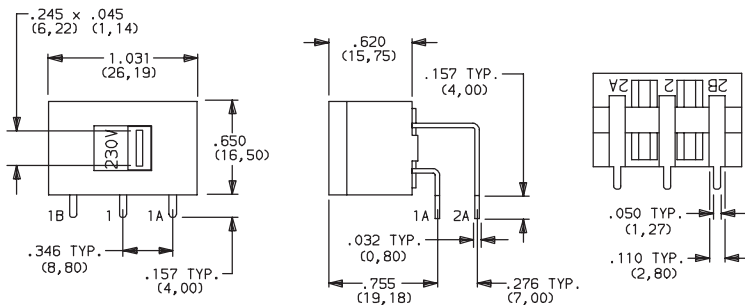

AVAILABLE WITH:

Models: All
Terminations: 08

PC MOUNTING

PC mount, side actuated.
For mounting information,
see TERMINATIONS section, page J-35.



Third Angle
Projection

Dimensions are shown: Inch (mm)
Specifications and dimensions subject to change



V Series Power & Line Voltage Select Slide Switches

TERMINATIONS

05 QUICK CONNECT

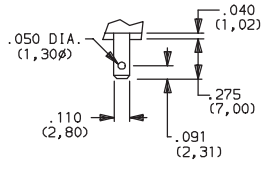

.032 THK.
(0,80)

Fits .110 in. quick connector.

02 PC THRU-HOLE

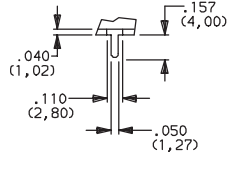

.032 THK.
(0,80)

PC MOUNTING

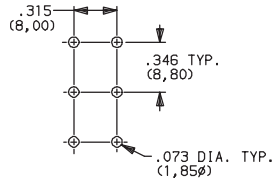

MS, SS Mounting Styles.

08 PC THRU-HOLE

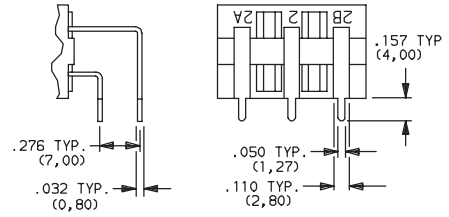

Not available with 'MS, SS or S2' mounting styles.

PC MOUNTING

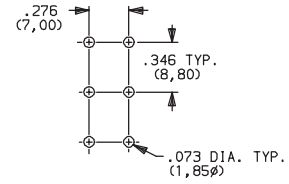

MA, SL Mounting Styles.

CONTACT MATERIAL

OPTION CODE	CONTACT MATERIAL	RATINGS	
Q	SILVER ¹	POWER	10.1 AMPS @ 125 V AC; 4 AMPS @ 28 V DC; 5 AMPS @ 250 V AC (UL/CSA); 2.0 (0.5) AMPS @ 250 V AC, T85 (VDE).

* Note: See Technical Data section of this catalog for RoHS compliant and compatible definitions and specifications.

¹ CONTACTS & TERMINALS: Copper, silver plated (standard with all termination options).

All models with all options. V70X and V80X models .

NOTE: Any models supplied with Q contact material are RoHS compliant.

SEAL

NONE NO SEAL

E EPOXY SEAL

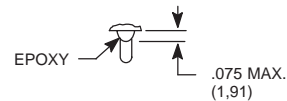

Dimensions are shown: Inch (mm)
Specifications and dimensions subject to change



Slide

OS Series Miniature Slide Switches

Features/Benefits

- Variety of actuators & terminations
- PC and panel mounting
- Gold or silver plating available
- Shorting or non-shorting contacts
- RoHS compliant

Typical Applications

- Test & measurement equipment
- Computer peripherals & network products
- Consumer products



Specifications

CONTACT RATING: See individual parts.
 MECHANICAL & ELECTRICAL LIFE: 10,000 cycles.
 CONTACT RESISTANCE: 20 m Ω or less.
 INSULATION RESISTANCE: 100 m Ω min. at 500 VDC.
 DIELECTRIC STRENGTH: 500 VAC for 1 minute.
 OPERATING TEMPERATURE: -10°C to +70°C.
 PACKAGING: Bulk

* For RoHS compatible switches contact customer service.

Materials

BASE: Phenolic resin.
 ACTUATOR: POM, black.
 HOUSING PLATE: SPCC Sn plated.
 MOVABLE CONTACT: Copper alloy, silver plated or gold.
 STATIONARY CONTACTS: Brass, silver plated.
 TERMINALS: Brass, silver plated (Gold plate - Contact customer service).
 TERMINAL SEAL: None.

NOTE: Specifications and materials listed above are for switches with standard options. For information on specific and custom switches, consult Customer Service Center.



Slide

How To Order

Complete part numbers for OS Series Slide Switches are shown on pages J-37 through J-43.

PART NUMBER	SWITCH FUNCTION	
	POS. 1	POS. 2
OS102011MS2QN1 (Non-shorting)	ON	ON
OS102011MS2QS1 (Shorting)	ON	ON
CONN. TERMINALS	1-2	2-3
SCHEMATIC		
SPDT		
CONTACT RATING: 0.1A @ 12 VDC		

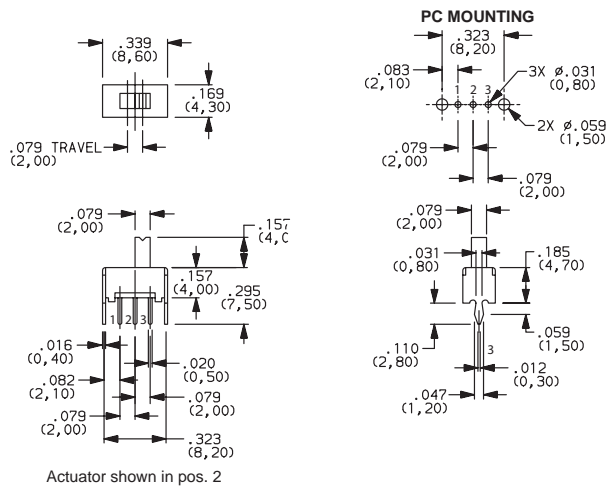

PART NUMBER	SWITCH FUNCTION		
	POS. 1	POS. 2	POS. 3
OS103011MS8QP1 (Non-specified)	ON	ON	ON
CONN. TERMINALS	1-2	2-3	2-4
SCHEMATIC			
SP3T			
CONTACT RATING: 0.1A @ 12 VDC			

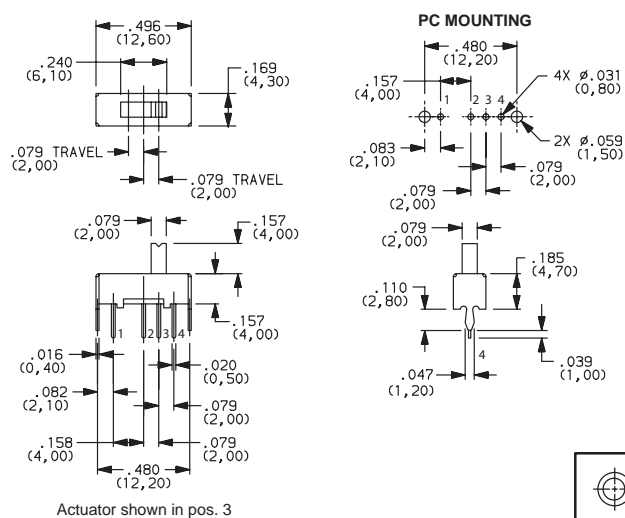

Dimensions are shown: Inch (mm)
 Specifications and dimensions subject to change



OS Series Miniature Slide Switches



OS202011MS2QS1
DPDT

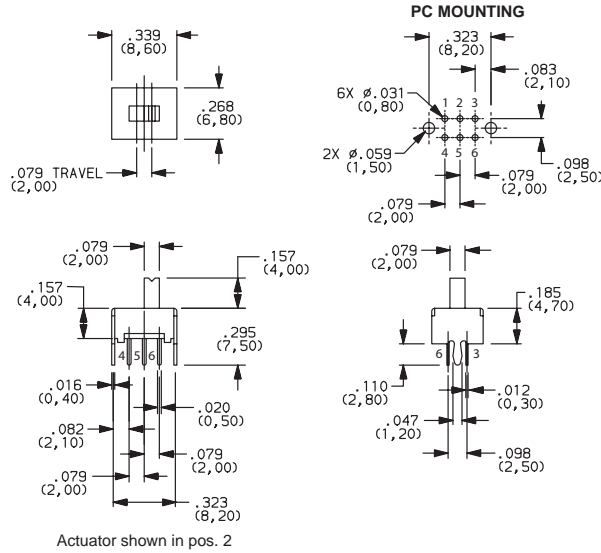

PART NUMBER	SWITCH FUNCTION	
	POS.1	POS. 2
OS202011MS2QS1 (Shorting)	ON	ON
OS202011MS2QN1 (Non-shorting)	ON	ON
CONN. TERMINALS	1-2,4-5	2-3,5-6
SCHEMATIC		
DPDT		
CONTACT RATING: 0.1A @ 12 VDC		



OS203011MS1QP1
DP3T

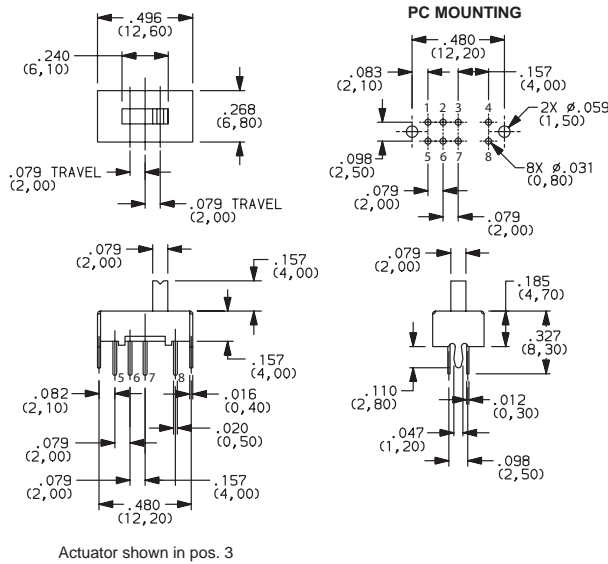

PART NUMBER	SWITCH FUNCTION		
	POS.1	POS. 2	POS. 3
OS203011MS1QP1 (Non-specified)	ON	ON	ON
CONN. TERMINALS	1-3,5-7	2-3,6-7	3-4,7-8
SCHEMATIC			
DP3T			
CONTACT RATING: 0.3A @ 30 VDC			



OS202013MT5QN1
DPDT

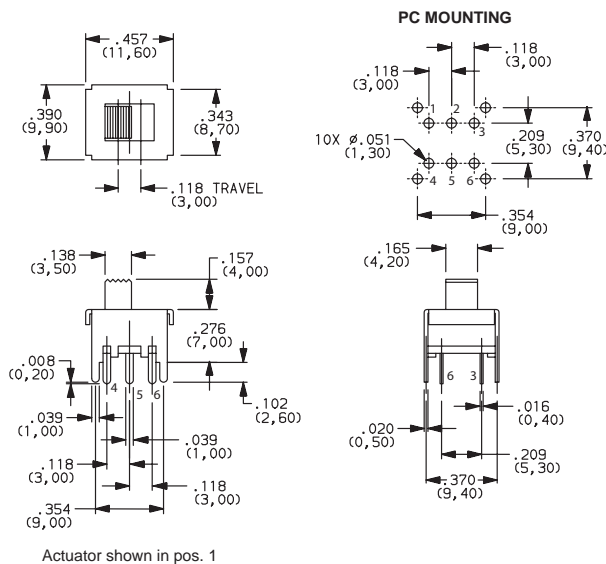

PART NUMBER	SWITCH FUNCTION	
	POS.1	POS. 2
OS202013MT5QN1 (Non-shorting)	ON	ON
CONN. TERMINALS	1-2,4-5	2-3,5-6
SCHEMATIC		
DPDT		
CONTACT RATING: 0.3A @ 30 VDC		



Dimensions are shown: IN (mm)
Specifications and dimensions subject to change



Slide

OS Series Miniature Slide Switches

PART NUMBER	SWITCH FUNCTION		
	POS. 1	POS. 2	POS. 3
OS203013MT7QN1 (Non-shorting)	ON	OFF	ON
CONN. TERMINALS	1-2,4-5		2-3,5-6
SCHEMATIC			
DP3T			
CONTACT RATING: 0.3A @ 30 VDC			

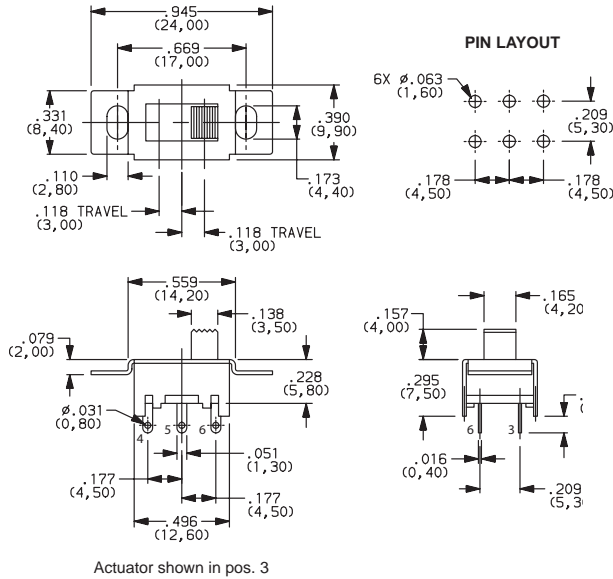

OS203013MT7QN1
DP3T



Slide

PART NUMBER	SWITCH FUNCTION	
	POS. 1	POS. 2
OS202013MT8QN1 (Non-shorting)	ON	ON
CONN. TERMINALS	1-2,4-5	2-3,5-6
SCHEMATIC		
DPDT		
CONTACT RATING: 0.3A @ 30 VDC		

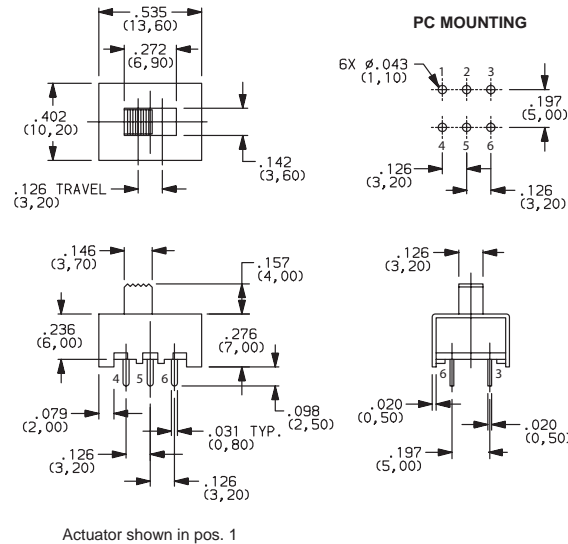

OS202013MT8QN1
DPDT

PART NUMBER	SWITCH FUNCTION		
	POS. 1	POS. 2	POS. 3
OS203013MT8QN1 (Non-shorting)	ON	ON	ON
CONN. TERMINALS	1-2,5-6	2-3,6-7	3-4,7-8
SCHEMATIC			
DP3T			
CONTACT RATING: 0.3A @ 30 VDC			

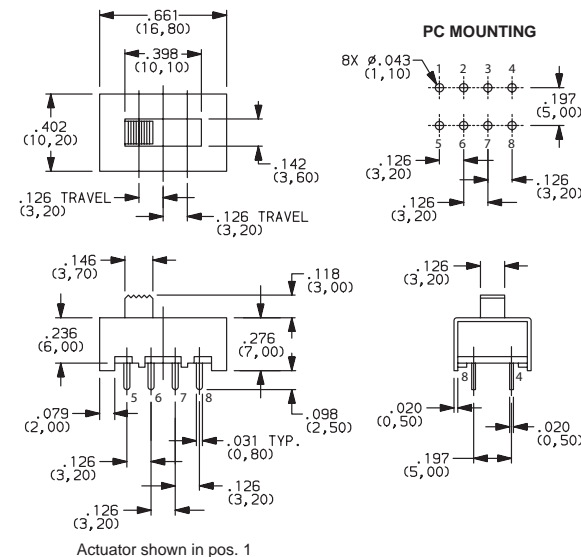

OS203013MT8QN1
DP3T



Dimensions are shown: Inch (mm)
Specifications and dimensions subject to change



OS Series Miniature Slide Switches



OS203013MT6QN1
DP3T

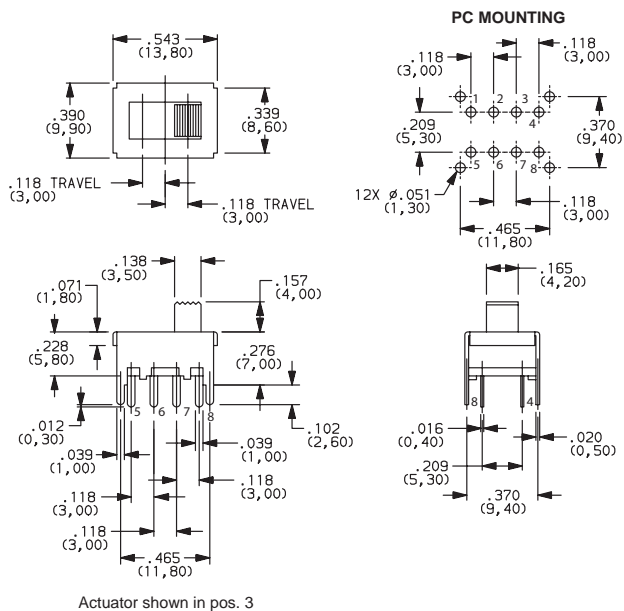

PART NUMBER	SWITCH FUNCTION		
	POS.1	POS. 2	POS. 3
OS203013MT6QN1 (Non-shorting)	ON	ON	ON
CONN. TERMINALS	1-2,5-6	2-3,6-7	3-4,7-8
SCHEMATIC			
DP3T			
CONTACT RATING: 0.2A @ 30 VDC			



OS103012MU1QP1
SP3T

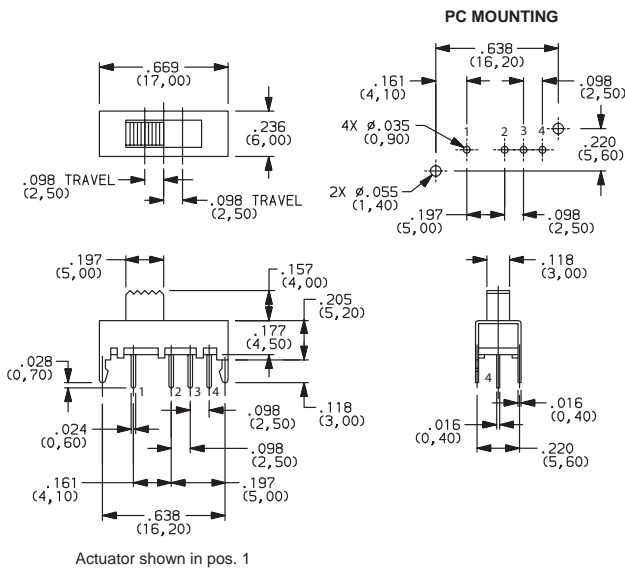

PART NUMBER	SWITCH FUNCTION		
	POS.1	POS. 2	POS. 3
OS103012MU1QP1 (Non-shorting)	ON	ON	ON
CONN. TERMINALS	1-2	2-3	2-4
SCHEMATIC			
SP3T			
CONTACT RATING: 0.2A @ 30 VDC			



OS103012MU2QP1
SP3T

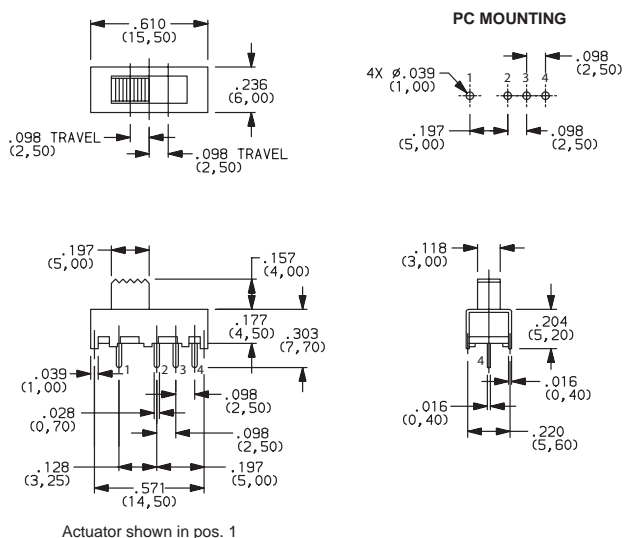

PART NUMBER	SWITCH FUNCTION		
	POS.1	POS. 2	POS. 3
OS103012MU2QP1 (Non-shorting)	ON	ON	ON
CONN. TERMINALS	1-2	2-3	2-4
SCHEMATIC			
SP3T			
CONTACT RATING: 0.2A @ 30 VDC			



Slide

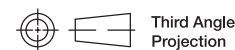

Third Angle Projection
Dimensions are shown: IN (mm)
Specifications and dimensions subject to change

OS Series Miniature Slide Switches

PART NUMBER	SWITCH FUNCTION		
	POS. 1	POS. 2	POS. 3
OS203012MU5QP1 (Non-specified)	ON	ON	ON
CONN. TERMINALS	1-2,5-6	2-3,6-7	2-4,6-8
SCHEMATIC			
DP3T			
CONTACT RATING: 0.1A @ 30 VDC			

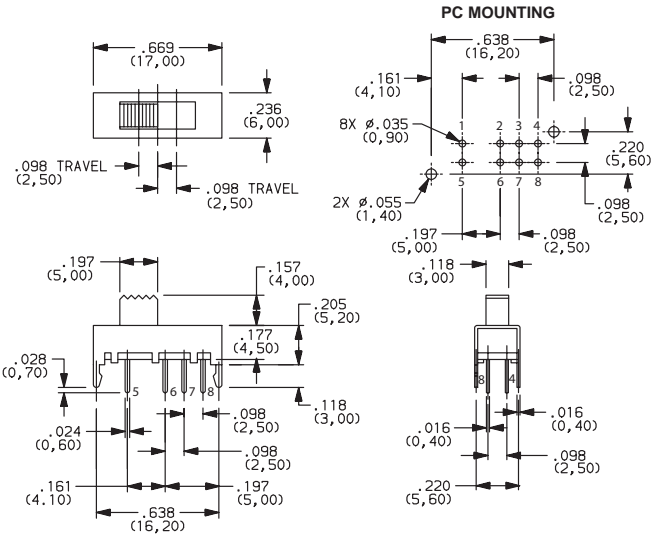

OS203012MU5QP1
DP3T

Actuator shown in pos. 1

PART NUMBER	SWITCH FUNCTION	
	POS. 1	POS. 2
OS202011MV4QN1 (Non-shorting)	ON	ON
OS202011MV4QS1 (Shorting)	ON	ON
CONN. TERMINALS	1-2,4-5	2-3,5-6
SCHEMATIC		
DPDT		
CONTACT RATING: 0.1A @ 30 VDC		

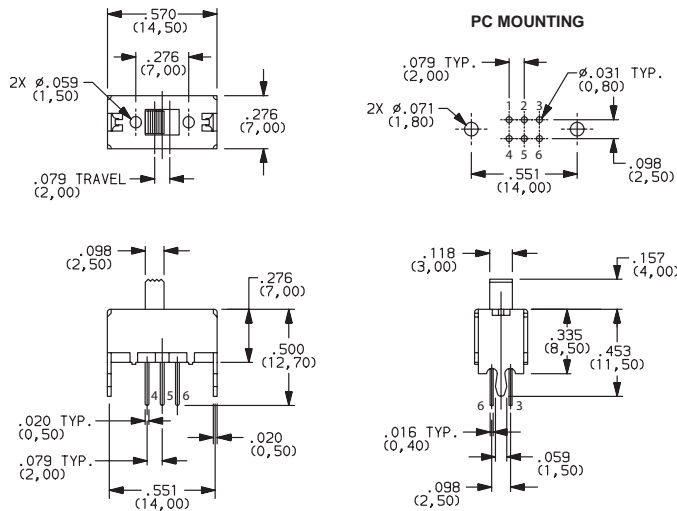

OS202011MV4QN1
DPDT

Actuator shown in pos. 1

PART NUMBER	SWITCH FUNCTION		
	POS. 1	POS. 2	POS. 3
OS203011MV9QS1 (Shorting)	ON	ON	ON
OS203011MV9QN1 (Non-shorting)	ON	ON	ON
CONN. TERMINALS	1-2-5, 6-7-10	1-3-5, 6-8-10	1-4-5, 6-9-10
SCHEMATIC			
DP3T			
CONTACT RATING: 0.1A @ 30 VDC			

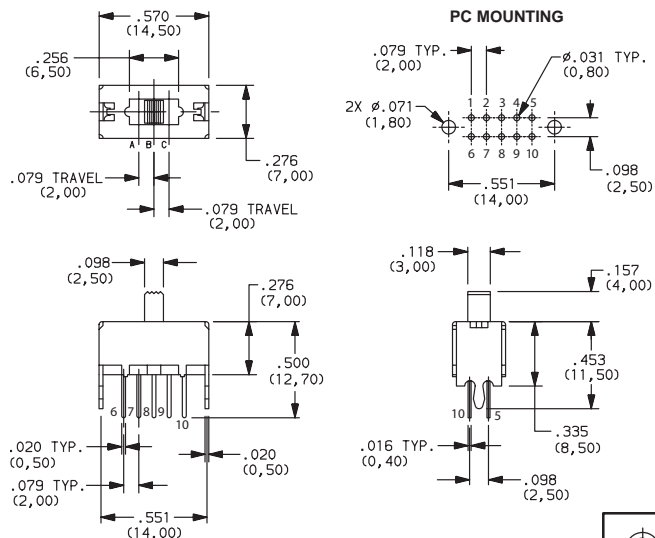

OS203011MV9QS1
DP3T

Actuator shown in pos. 2(A)



Dimensions are shown: Inch (mm)
Specifications and dimensions subject to change



Slide

OS Series Miniature Slide Switches



OS102011MA1QN1
SPDT

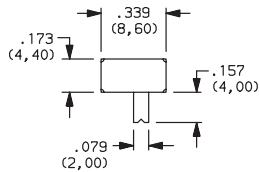

PC MOUNTING

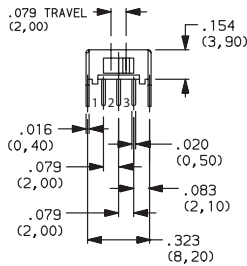
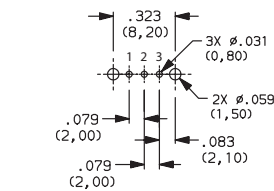

Actuator shown in pos. 2

PART NUMBER	SWITCH FUNCTION	
	POS.1	POS. 2
OS102011MA1QN1 (Non-shorting)		
OS102011MA1QS1 (Shorting)		
CONN. TERMINALS	1-2	2-3
SCHEMATIC		
SPDT		
CONTACT RATING: 0.1A @ 12 VDC		



Slide



OS103011MA7QP1
SP3T

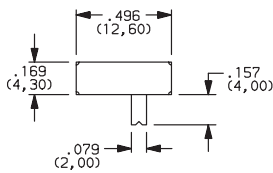

PC MOUNTING

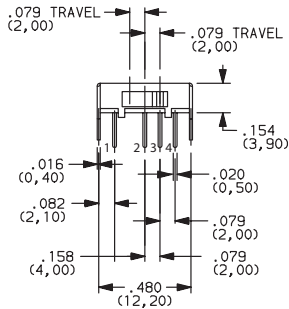
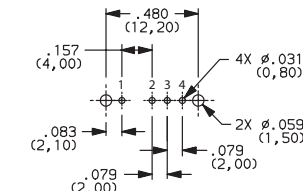

Actuator shown in pos. 3

PART NUMBER	SWITCH FUNCTION		
	POS.1	POS. 2	POS. 3
OS103011MA7QP1 (Non-specified)			
CONN. TERMINALS	1-2	2-3	2-4
SCHEMATIC			
SP3T			
CONTACT RATING: 0.1A @ 12 VDC			



OS203011MA2QP1
DP3T

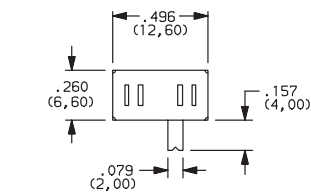

PC MOUNTING

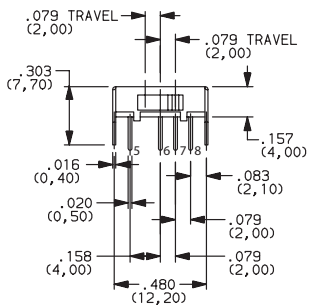
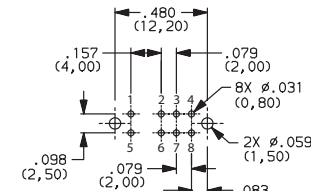

Actuator shown in pos. 3

PART NUMBER	SWITCH FUNCTION		
	POS.1	POS. 2	POS. 3
OS203011MA2QP1 (Non-specified)			
CONN. TERMINALS	1-2,5-6	2-3,6-7	2-4,6-8
SCHEMATIC			
DP3T			
CONTACT RATING: 0.1A @ 12 VDC			



Dimensions are shown IN (mm)
Specifications and dimensions subject to change



OS Series Miniature Slide Switches

PART NUMBER	SWITCH FUNCTION	
	POS. 1	POS. 2
OS202011MA0QN1 (Non-shorting)	ON	ON
OS202011MA0QS1 (Shorting)	ON	ON
CONN. TERMINALS	1-2,4-5	2-3,5-6
SCHEMATIC		
DPDT		
CONTACT RATING: 0.1A @ 12 VDC		

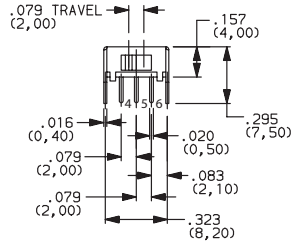
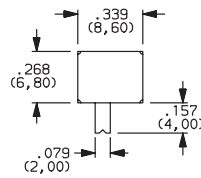

Actuator shown in pos. 1

PC MOUNTING

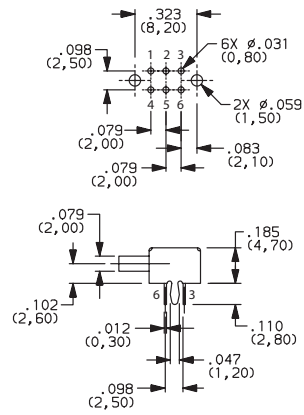

OS202011MA0QN1
DPDT



Slide

PCM Series Ultraminiature Surface Mount Slide Switches



Features/Benefits

- Ultraminiature surface mount
- Low profile
- SPDT & SP3T models
- RoHS compliant

Typical Applications

- Computer peripherals & network products
- Telecommunication products
- Test & measurement equipment



Slide

Specifications

CONTACT RATING: 0.3A @ 6 VDC.
 MECHANICAL LIFE: 10,000 cycles.
 CONTACT RESISTANCE: 70 m Ω max.
 INSULATION RESISTANCE: 100 m Ω min. @ 500V.
 DIELECTRIC STRENGTH: 500 VAC min.
 OPERATING TEMPERATURE: -20°C to +85°C.
 SOLDERABILITY: 255C max. solder temperature.
 PACKAGING: Tape & reel.

Materials

CASE: P.P.S.
 COVER: Stainless steel.
 SLIDER: Nylon 4/6
 BRUSH: Copper alloy silver clad.
 TERMINALS: Copper alloy, silver plated.

NOTE: All models RoHS compliant and compatible with all options.

NOTE: Specifications and materials listed above are for switches with standard options. For information on specific and custom switches, consult Customer Service Center.

How To Order

Complete part numbers for PCM Series Ultraminiature Surface Mount Slide Switches are shown below and on page J-45.

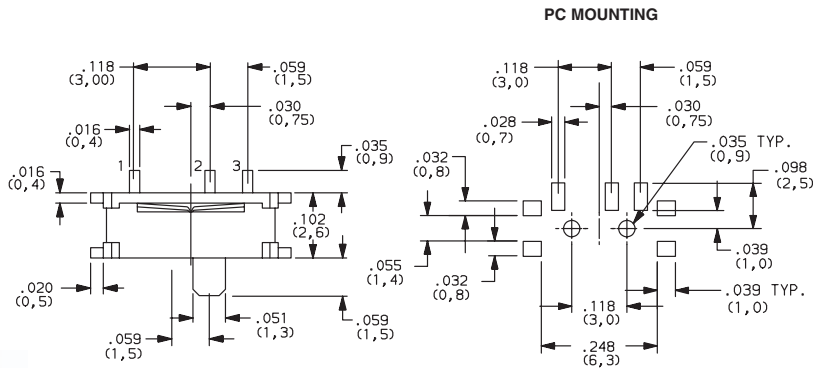

PART NUMBER	SWITCH FUNCTION	
	POS. 1	POS. 2
PCM12SMTR	ON	ON
CONN. TERMINALS	1-2	2-3
SCHEMATIC		
SPDT		

**PCM12SMTR
SPDT**

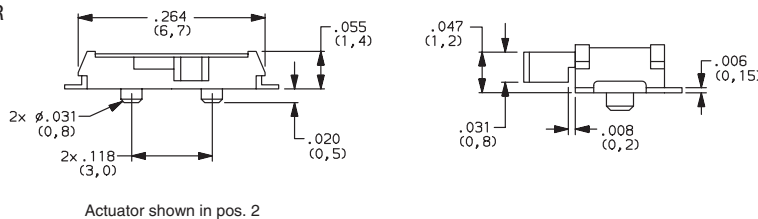

Dimensions are shown: Inch (mm)
 Specifications and dimensions subject to change

PCM Series Ultraminiature Surface Mount Slide Switches

PART NUMBER	SWITCH FUNCTION		
	POS. 1	POS. 2	POS. 3
PCM13SMTR	ON	ON	ON
CONN. TERMINALS	1-3	2-3	3-4
SCHEMATIC			
SP3T			

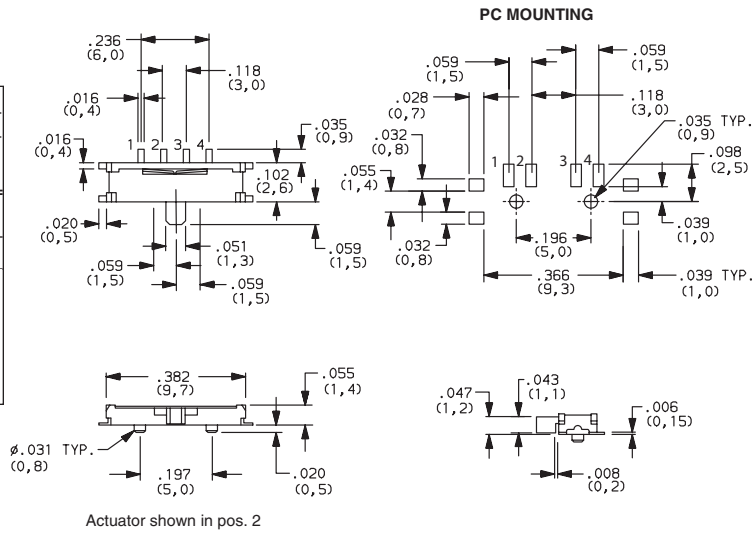

PCM13SMTR
SP3T



TAPE & REEL

For part number PCM12SMTR

Quantity per reel 3500

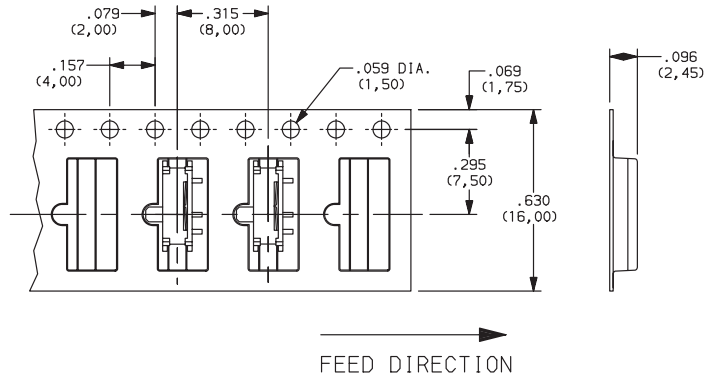

For part number PCM13SMTR

Quantity per reel 3500

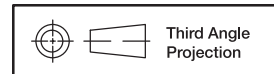
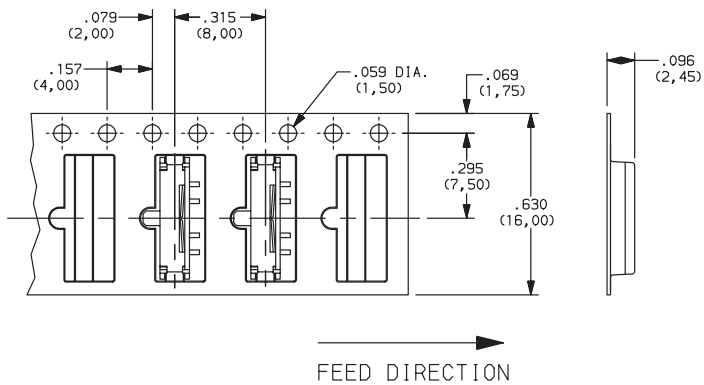

Dimensions are shown: Inch (mm)
Specifications and dimensions subject to change

AYZ Series Miniature Slide Switches



Features/Benefits

- Low profile
- Single & double pole models
- Double & triple throw models
- RoHS compatible

Typical Applications

- Computer peripherals & network products
- Telecommunication products
- Test & measurement equipment



Slide

Specifications

MAX. SWITCHING POWER: 1.2 VA
 MAX. SWITCHING VOLTAGE: 12 VDC
 MAX. SWITCHING CURRENT: 100 mA
 MECHANICAL LIFE: 10,000 operations.
 CONTACT RESISTANCE: <math>< 80\text{m } \Omega</math>
 INSULATION RESISTANCE: >10⁸Ω
 DIELECTRIC STRENGTH: 0.1 kV at 50 Hz/1 min.
 OPERATING TEMPERATURE: -10°C to +60°C
 PACKAGING: Tape & reel, see page J-47.

Materials

HOUSING: Glass filled PPS (UL 94V-0).
 ACTUATOR: Glass filled nylon 6/6 (UL 94V-0), except options ending in C which are glass filled nylon 4/6 (UL94V-0).
 COVER: Nickel silver.
 MOVABLE CONTACT: Copper alloy, silver plated.
 FIXED CONTACT: Brass, silver plated.
 CONTACT SPRING: Contact bronze.

NOTE: Specifications and materials listed above are for switches with standard options. For information on specific and custom switches, consult Customer Service Center.

How To Order

Complete part numbers for AYZ Series Miniature Slide Switches are shown on pages J-46 through J-48.

PC MOUNTING

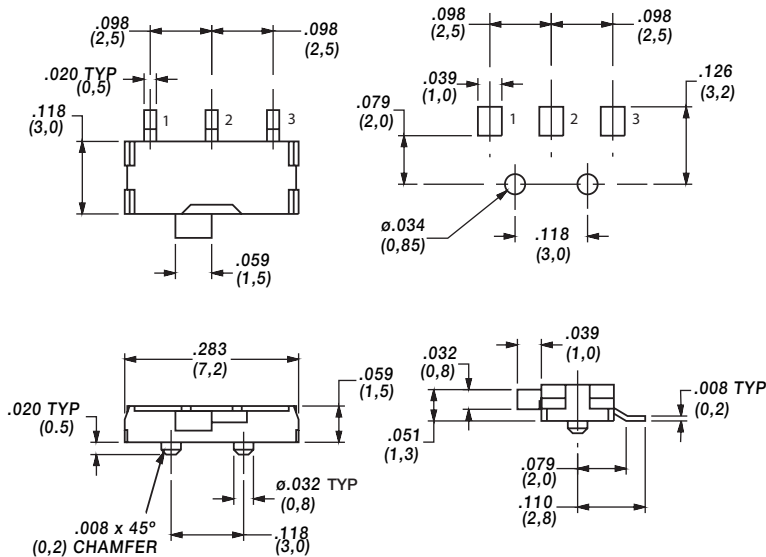

PART NUMBER	SWITCH FUNCTION		POS.1	POS.2
	RoHS Compliant	RoHS Compatible		
AYZ0102AGRLC	YES	YES	ON	ON
CONN. TERMINALS			1-2	2-3
SCHEMATIC				
SPDT				



Dimensions are shown: Inch (mm)
 Specifications and dimensions subject to change

AYZ Series Miniature Slide Switches

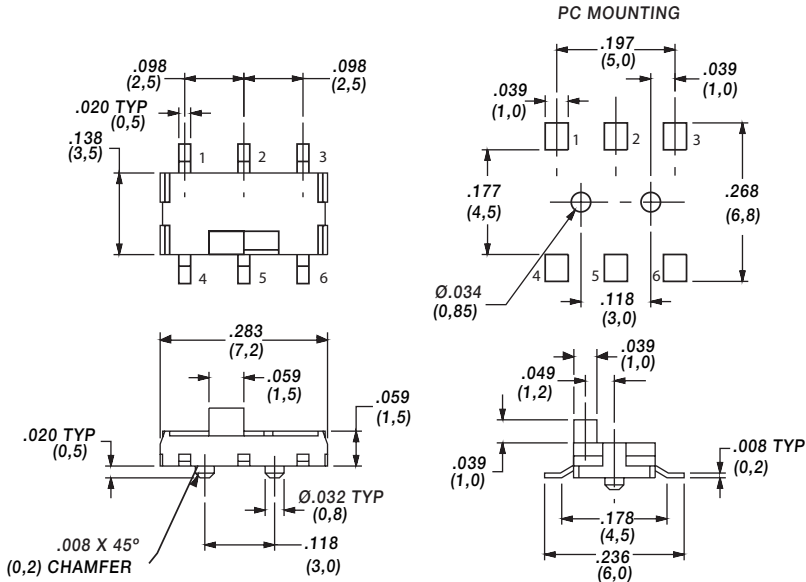

PART NUMBER	RoHS Compliant	RoHS Compatible	SWITCH FUNCTION	
			POS.1	POS.2
AYZ2020AGRLC	YES	YES	ON	ON
CONN. TERMINALS			1-2,4-5	2-3,5-6
SCHEMATIC				
DPDT				

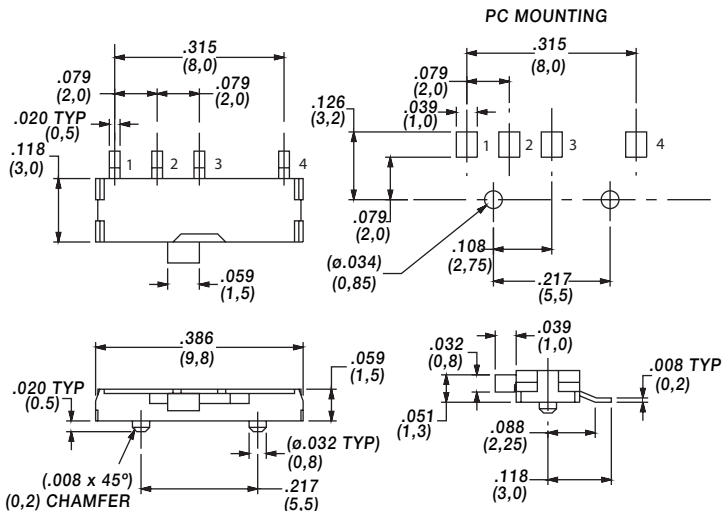

PART NUMBER	ROHS Compliant	ROHS Compatible	SWITCH FUNCTION		
			POS.1	POS.2	POS.3
AYZ103AGRLC	YES	YES	ON	ON	ON
CONN. TERMINALS			1-3	2-C	3-4
SCHEMATIC					
SP3T					

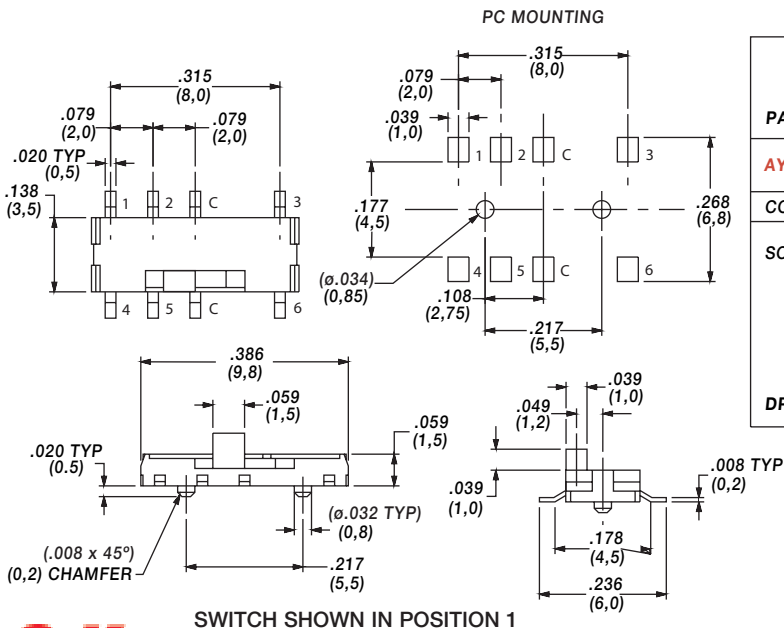

PART NUMBER	ROHS Compliant	ROHS Compatible	SWITCH FUNCTION		
			POS.1	POS.2	POS.3
AYZ203AGRLC	YES	YES	ON	ON	ON
CONN. TERMINALS			1-C,4-C	2-C,5-C	3-C,6-C
SCHEMATIC					
DP3T					



Dimensions are shown: Inch (mm)
Specifications and dimensions subject to change



Slide

AYZ Series Miniature Slide Switches

TAPE & REEL

For part number AYZ0102AGRLC

Quantity per reel 4000

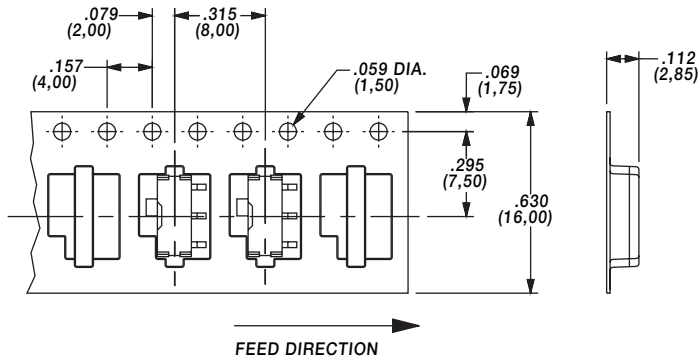

For part number AYZ0103AGRLC

Quantity per reel 4000

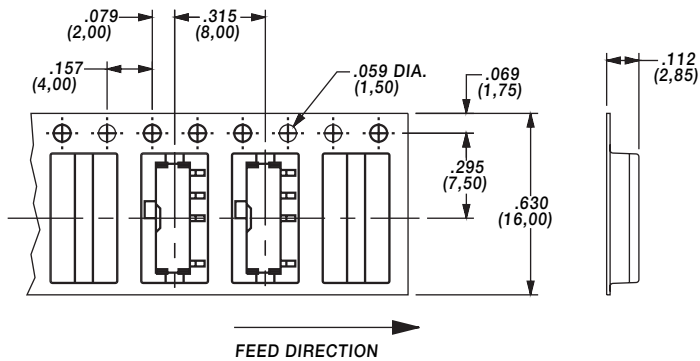

For part number AYZ0202AGRLC

Quantity per reel 3000

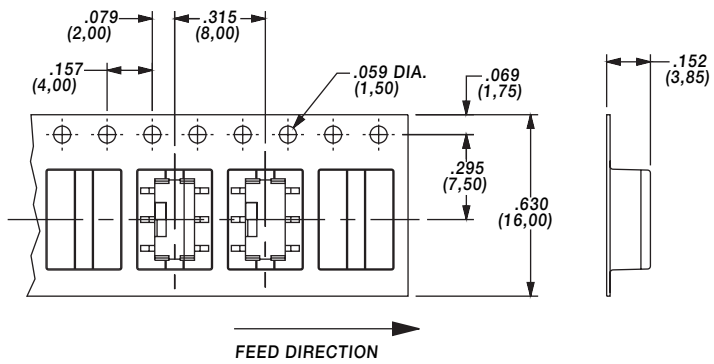

For part number AYZ0203AGRLC

Quantity per reel 3000

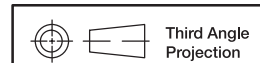
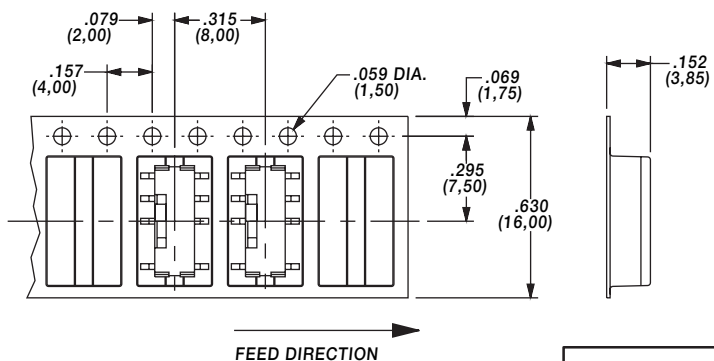

Dimensions are shown: Inch (mm)
Specifications and dimensions subject to change



JS Series Sub-Miniature Slide Switches

Features/Benefits

- Positive detent
- Low profile
- IR reflow to 260° solder profile
- Surface and thru hole mounting
- SPDT, DPDT, DP3T models
- RoHS compliant

Typical Applications

- Telecommunication products
- Computer peripherals
- Thermostat select switch
- Instrumentations

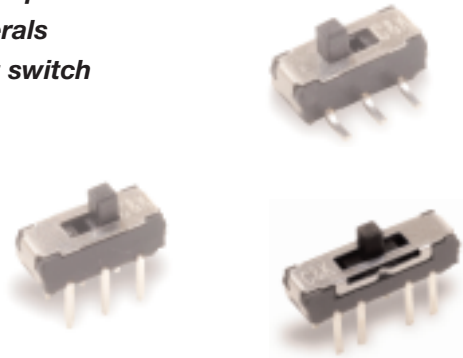

Specifications

CONTACT RATING: 6 VDC @ 0.3A
 ELECTRICAL LIFE: 5,000 make-and-break cycles at full load.
 CONTACT RESISTANCE: 70 mA max initial.
 INSULATION RESISTANCE: 100 ohms @500 VDC
 DIELECTRIC STRENGTH: 500 VAC min. @ sea level.
 OPERATING TEMPERATURE: -10°C to +60°C
 STORAGE TEMPERATURE: -30°C to +85°C

NOTE: Specifications and materials listed above are for switches with standard options.
 For information on specific and custom switches, consult Customer Service Center.

Materials

HOUSING: 4/6 nylon (UL94V-2), black.
 ACTUATOR: 4/6 nylon (UL94V-2), black.
 CONTACTS: Copper alloy, silver plated.
 TERMINALS: Brass, silver plated

RIGHT ANGLE, PC THRU-HOLE

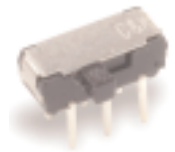
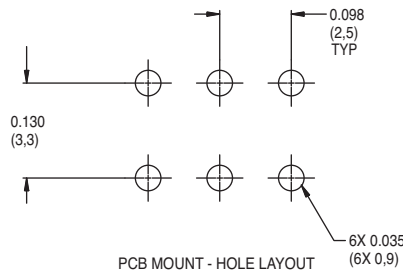
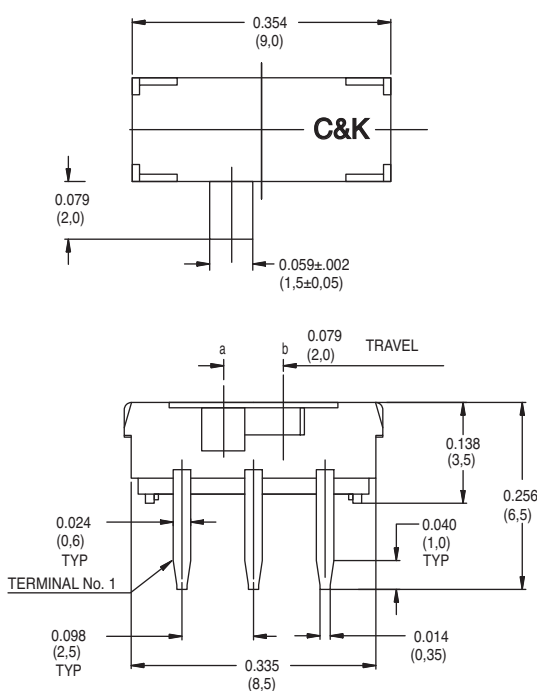

Part Number
 JS202011AQN
DPDT

Shown in position 1a

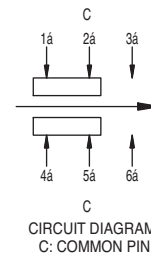
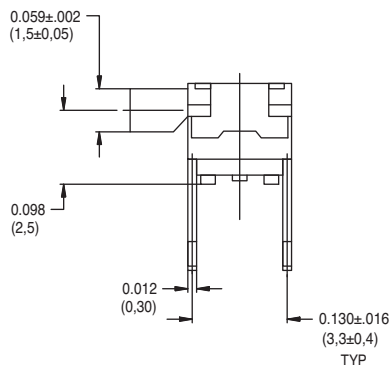

Dimensions are shown: Inch (mm)
 Specifications and dimensions subject to change



Slide

JS Series Sub-Miniature Slide Switches

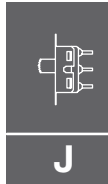

Slide

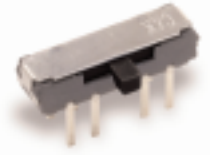
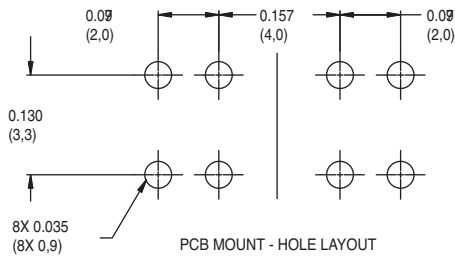
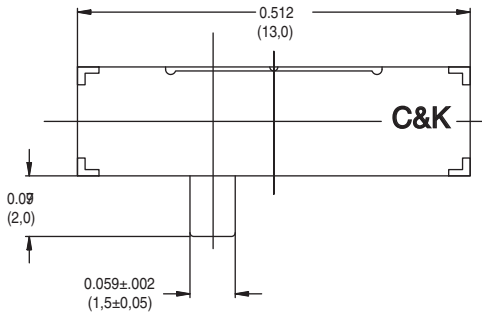

Part Number
JS203011AQN
DP3T

Shown in position 1a

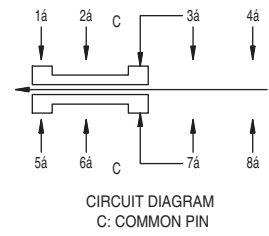
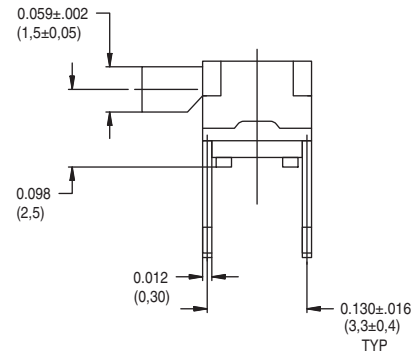
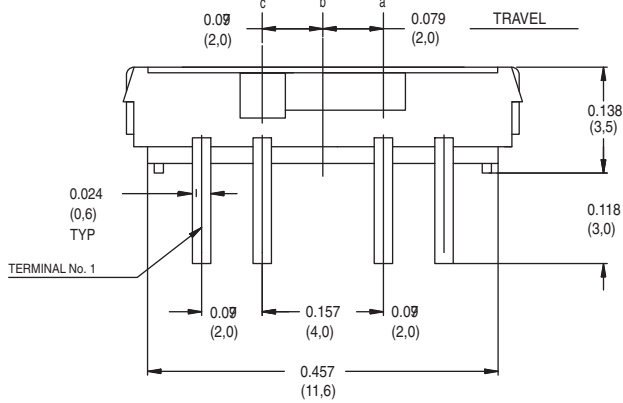

PC THRU-HOLE

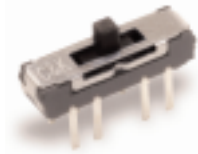
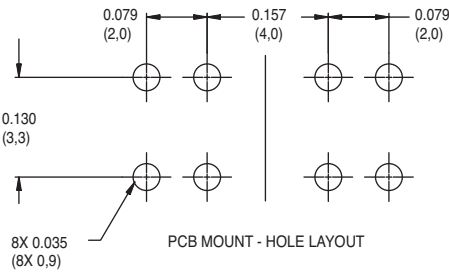
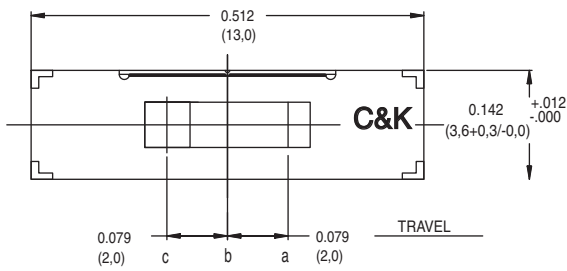

Part Number
JS203011CQN
DP3T

Shown in position 1a

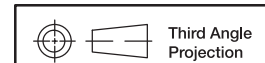
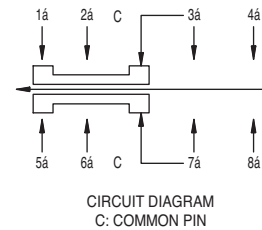
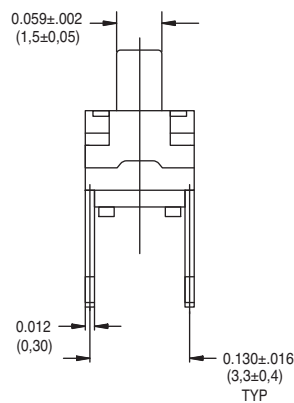
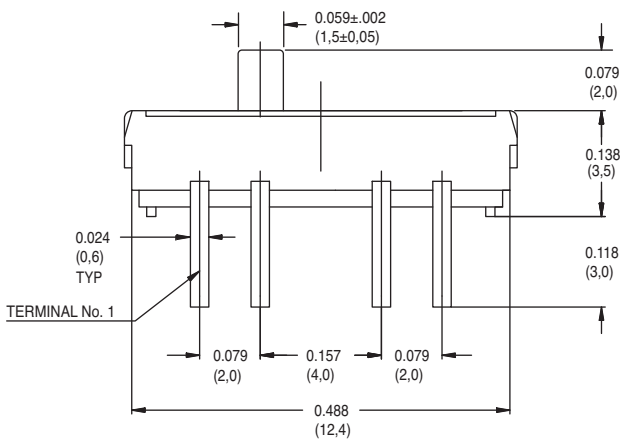

Dimensions are shown: Inch (mm)
Specifications and dimensions subject to change

JS Series Sub-Miniature Slide Switches

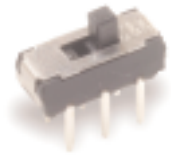
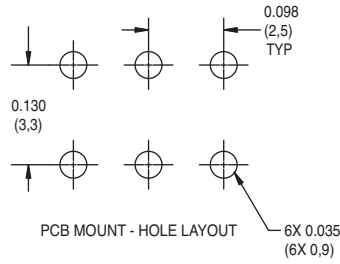
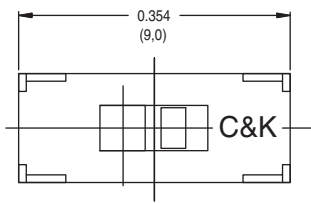

Part Number
JS202011CQN
DPDT

Shown in position 1a

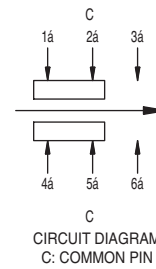
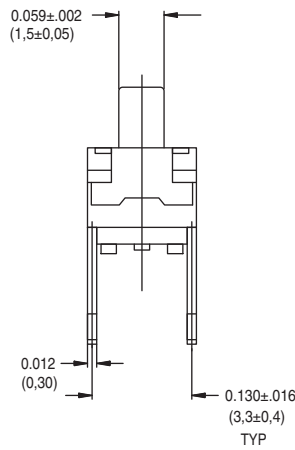
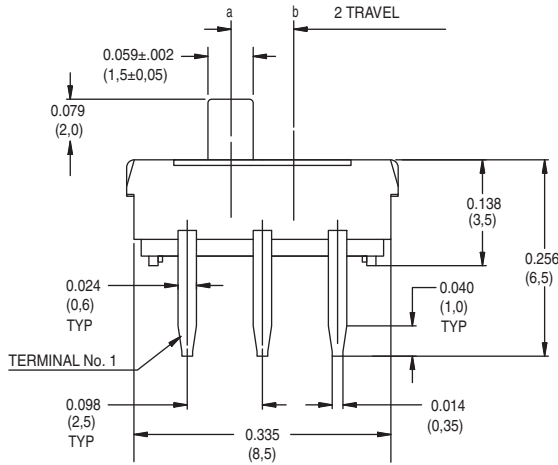

SURFACE MOUNT

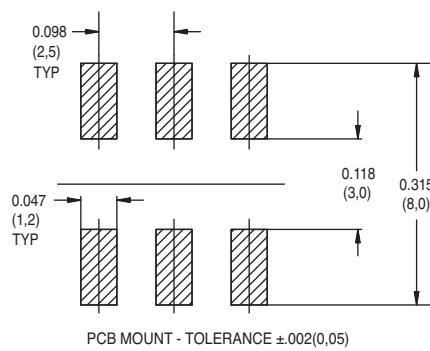
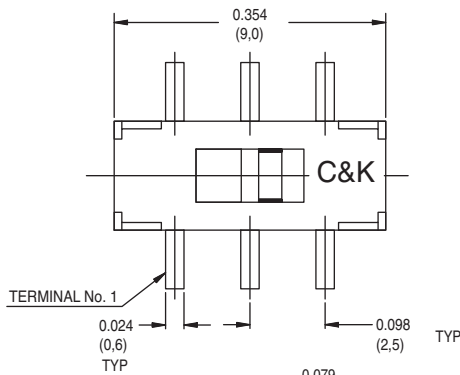

Part number
JS202011SCQN
DPDT

Shown in position 1a

Available in tape & reel
only, see page J-53

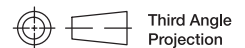
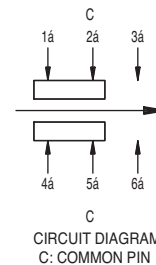
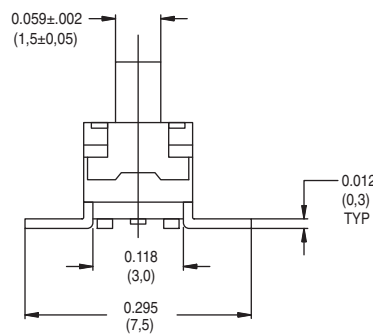
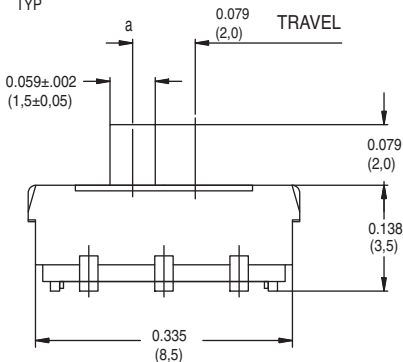

Dimensions are shown: Inch (mm)
Specifications and dimensions subject to change



Slide

JS Series Sub-Miniature Slide Switches

RIGHT ANGLE SURFACE MOUNT

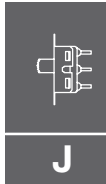

Slide

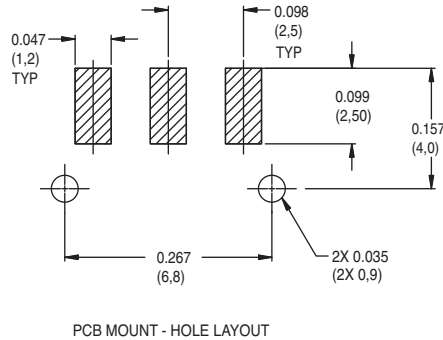
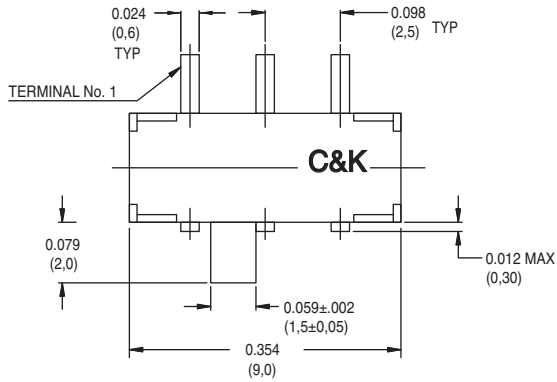

Part Number
JS102011SAQN
SPDT

Shown in position 1a

Available in tape & reel only, see page J-53

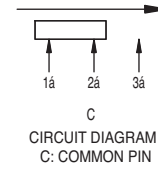
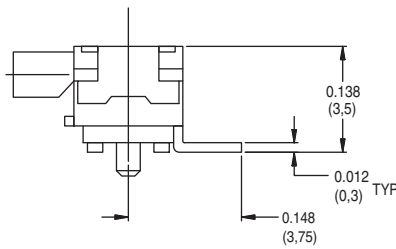
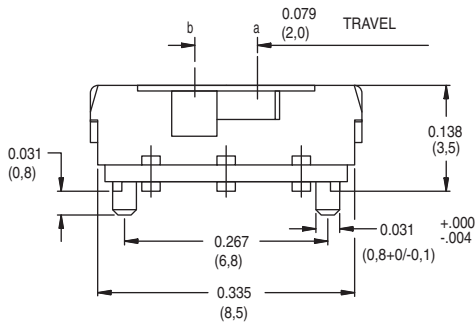

RIGHT ANGLE SURFACE MOUNT
LOW PROFILE .028±.004 (0.7±0.1) HIGH

Specifications

- CONTACT RATING: 5 VDC @ 1MA
- ELECTRICAL LIFE: 10,000 cycles.
- CONTACT RESISTANCE: <100 m ohms (initial) <200 m ohms (after processing).
- INSULATION RESISTANCE: 100 m ohms @500 VDC.
- DIELECTRIC STRENGTH: 250 VAC.
- OPERATING TEMPERATURE: -20°C to +70°C

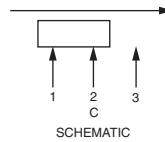
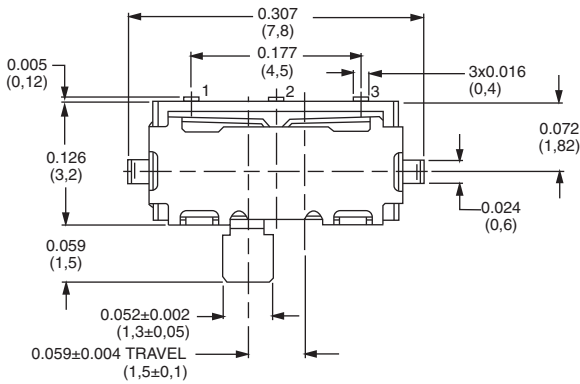

Part Number
JS102000SAQN
SPDT

Available in tape & reel only, see page J-53

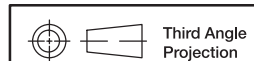
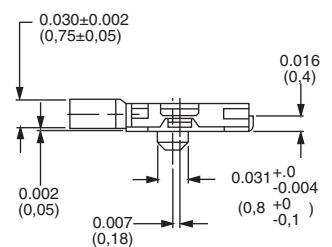
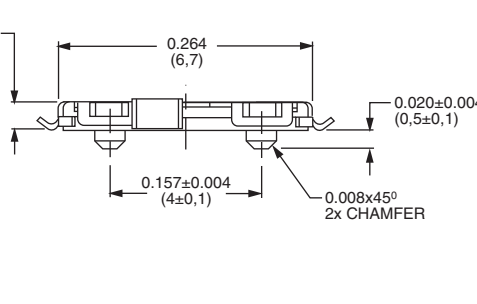
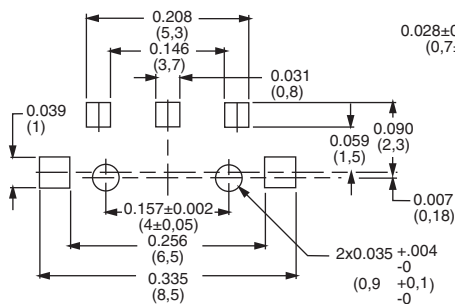

Dimensions are shown: Inch (mm)
Specifications and dimensions subject to change

JS Series Sub-Miniature Slide Switches

TAPE AND REEL FOR PART NUMBER JS10211SAQN

Quantity per reel 1000

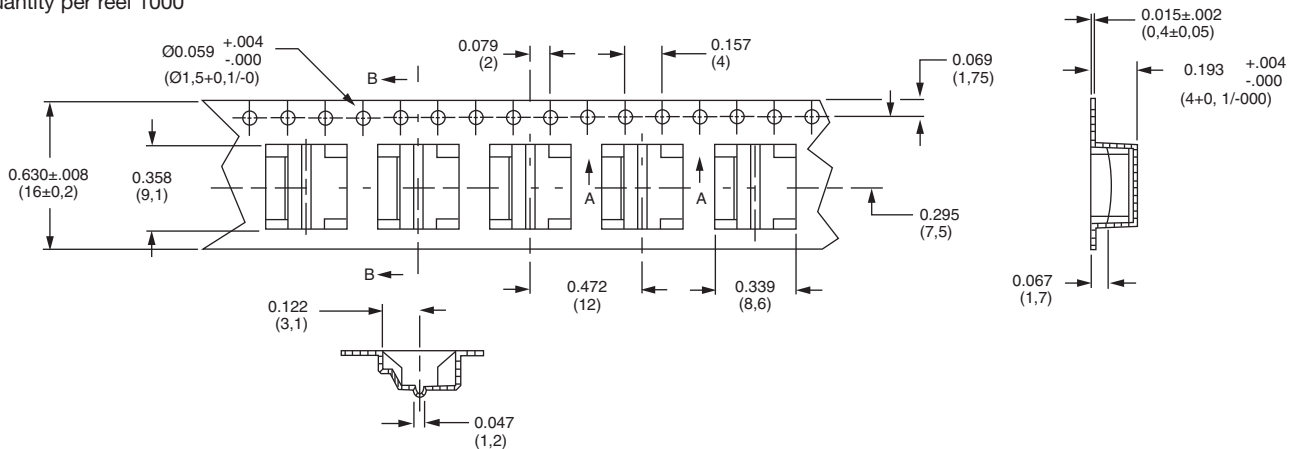

TAPE AND REEL FOR PART NUMBER JS102000SAQN

Quantity per reel 4000

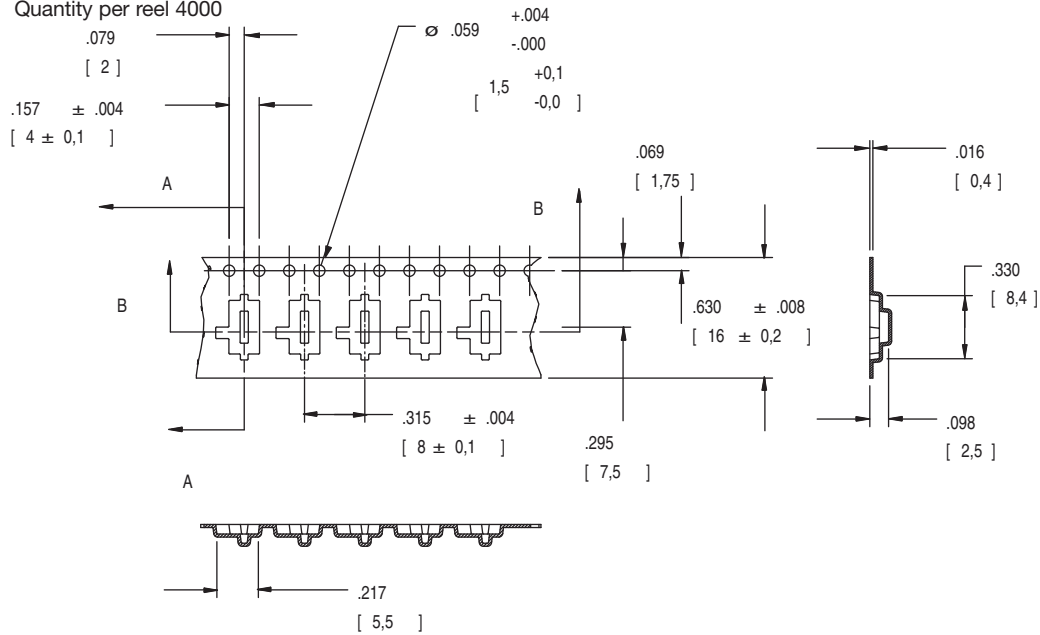

TAPE AND REEL FOR PART NUMBER JS202011SCQN

Quantity per reel 1000

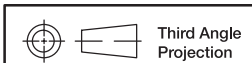
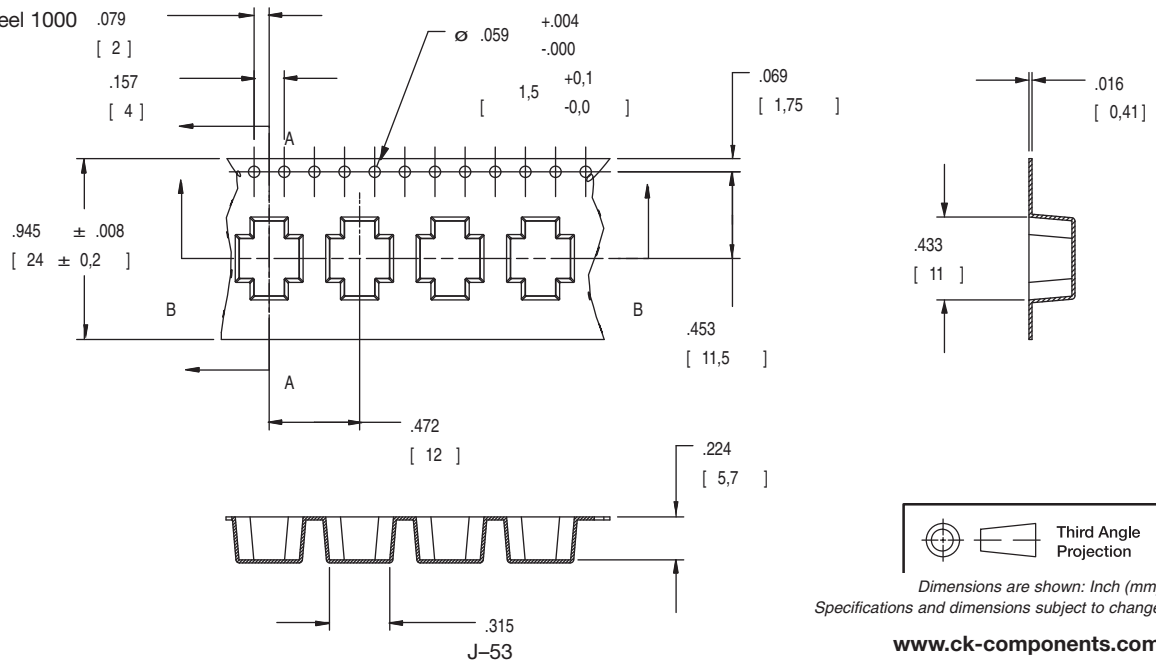

Dimensions are shown: Inch (mm)
Specifications and dimensions subject to change

www.ck-components.com



JSM Series Sub-Miniature Slide Switches

Features/Benefits

- RoHS compliant and meets all requirements of RoHS directive 2002/95EC
- Positive detent
- Low profile
- IR reflow to 260° solder profile
- Surface and thru hole mounting
- Maintained and momentary functions;
- SPDT, SP3T models

Typical Applications

- Telecommunication products
- Computer peripherals
- Thermostat select switch
- Instrumentations



Slide

Specifications

CONTACT RATING: 4 VDC @ 0.3A
 ELECTRICAL LIFE: 10,000 make-and-break cycles at full load.
 CONTACT RESISTANCE: 70 mA max initial.
 INSULATION RESISTANCE: 100 ohms @500 VDC
 DIELECTRIC STRENGTH: 100 VAC min. @ sea level.
 OPERATING TEMPERATURE: -10°C to +60°C
 STORAGE TEMPERATURE: -30°C to +85°C

NOTE: Specifications and materials listed above are for switches with standard options. For information on specific and custom switches, consult Customer Service Center.

Materials

HOUSING: LCP, Glass filled
 ACTUATOR: 4/6 nylon (UL94V-2), black.
 CONTACTS: Beryllium copper, silver plated.
 TERMINALS: Brass, silver plated.
 COVER: Stainless steel
 RETURN SPRING: Stainless steel

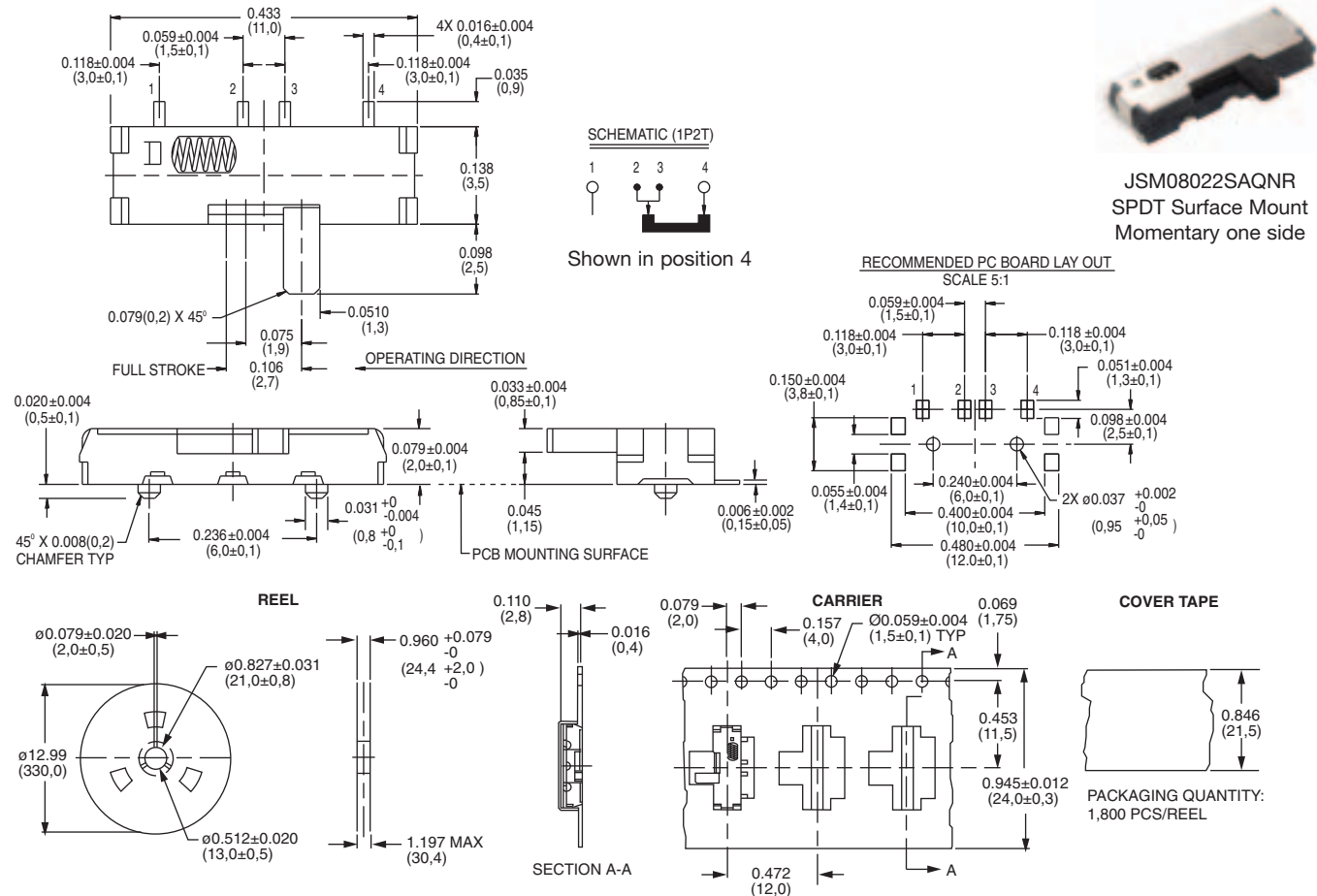

Dimensions are shown: Inch (mm)
 Specifications and dimensions subject to change

JSM Series Sub-Miniature Slide Switches



JSM08022SAQNL
SPDT Surface Mount
Momentary only

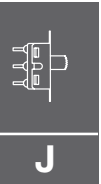
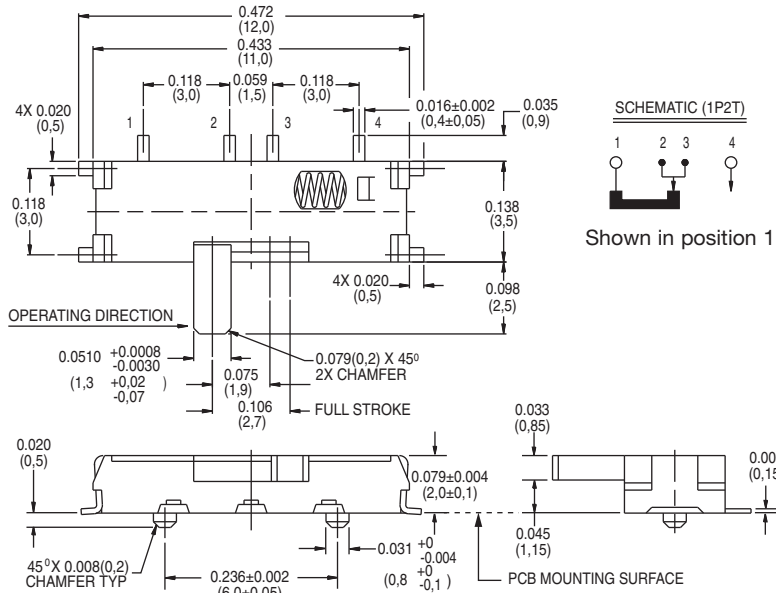

Slide

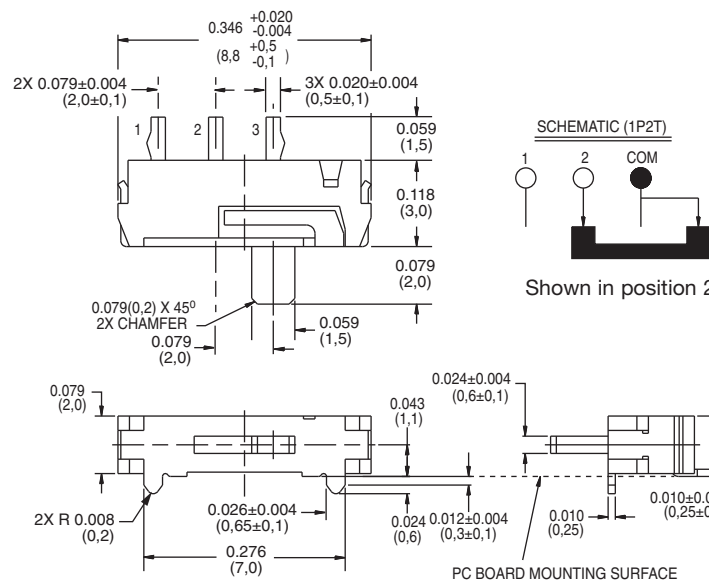

JSM08011SAQNR
SPDT Surface Mount
Momentary only

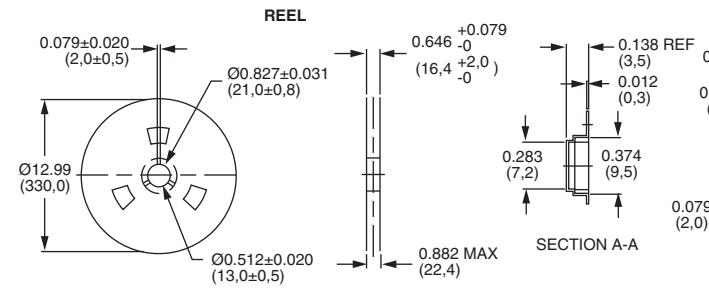

Dimensions are shown: Inch (mm)
Specifications and dimensions subject to change



JSM Series Sub-Miniature Slide Switches



JSM08011SAQNL
SPDT Surface Mount
Momentary only

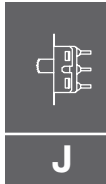

Slide

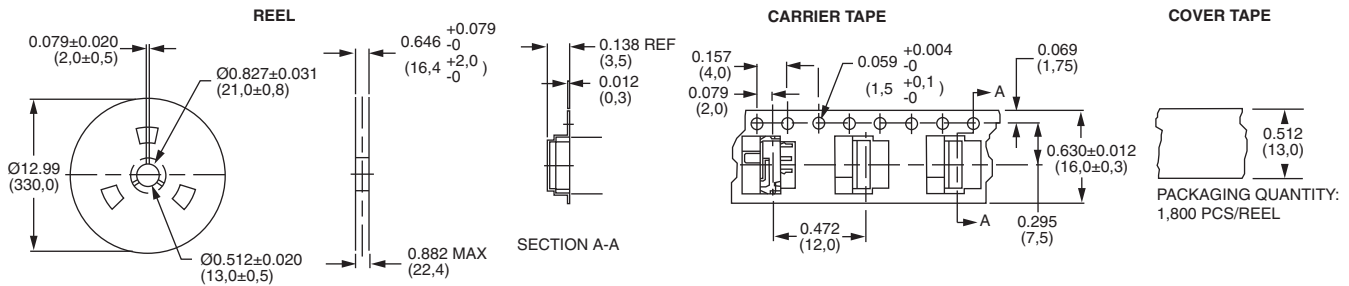
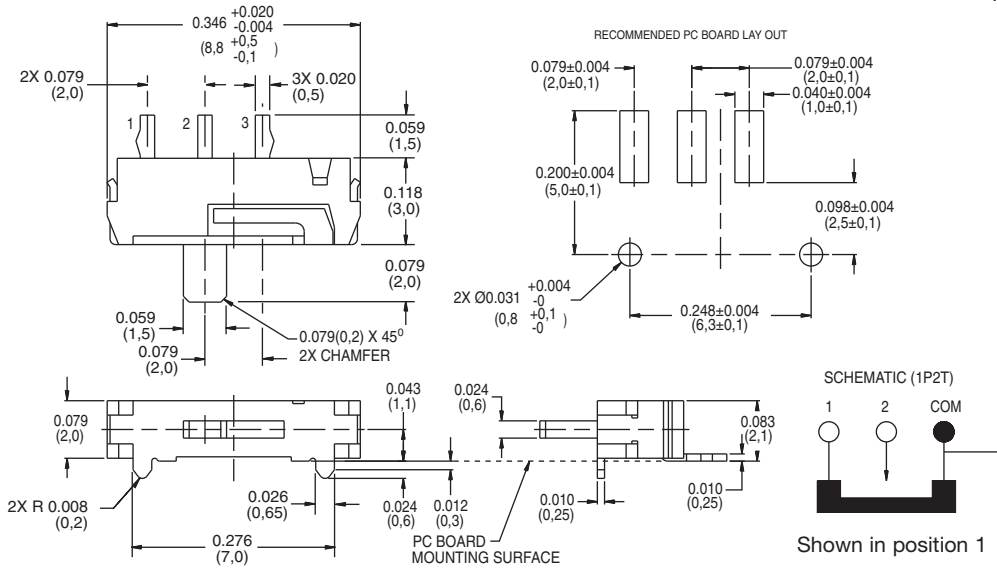

Third Angle
Projection
Dimensions are shown: Inch (mm)
Specifications and dimensions subject to change

JSM Series Sub-Miniature Slide Switches



JSM07011SAQNR
SP3T Surface Mount
Momentary one side
& Maintained the other

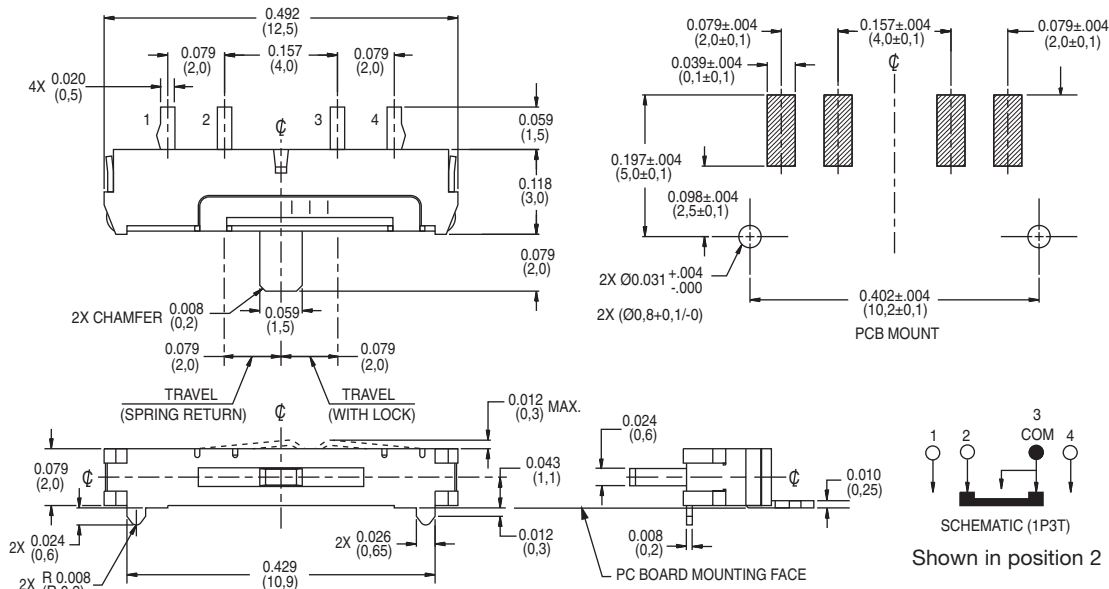

Slide

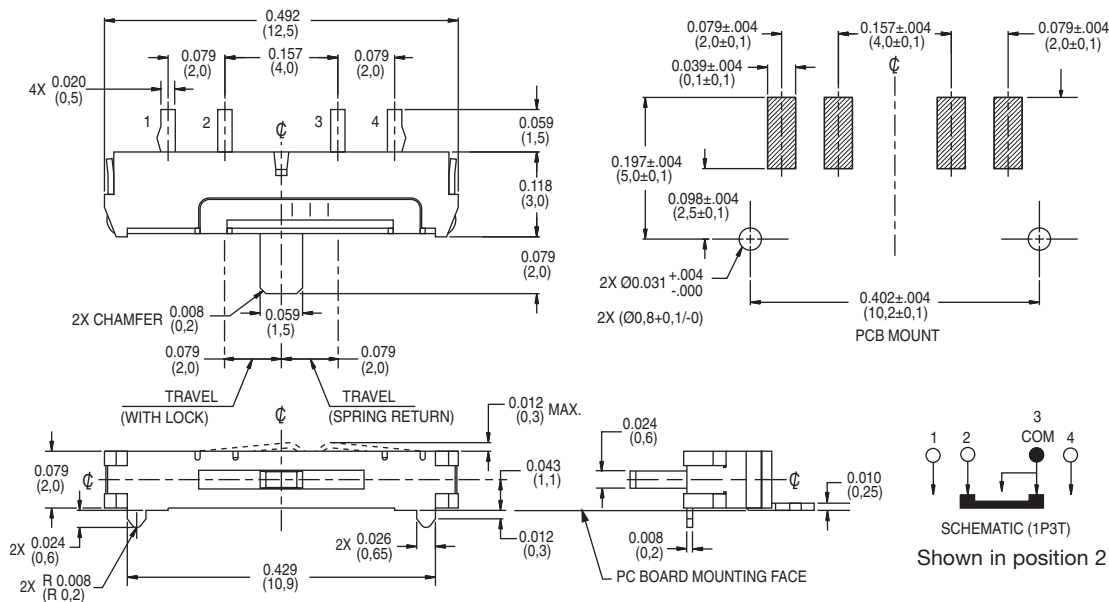

JSM07011SAQNL
SP3T Surface Mount
Momentary one side
& Maintained the other

Packaging for JSM07011SAQNR and JSM07011SAQNL

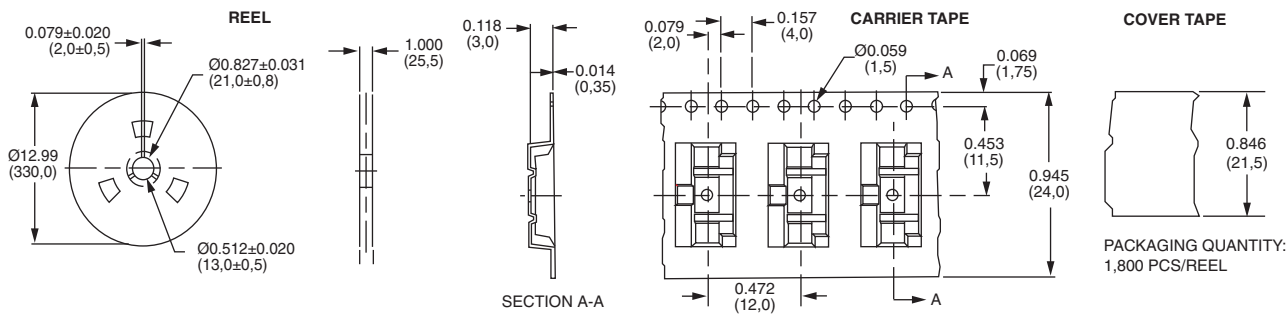

Dimensions are shown: Inch (mm)
Specifications and dimensions subject to change

JSM Series Sub-Miniature Slide Switches



JSM05000SAQN
SP3T Surface Mount
Momentary both
sides

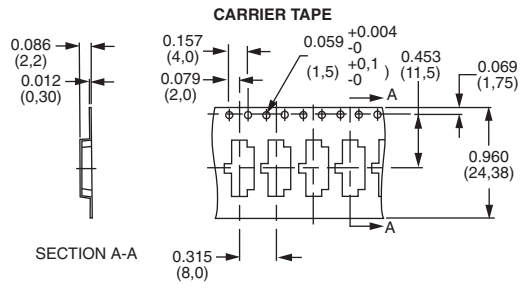
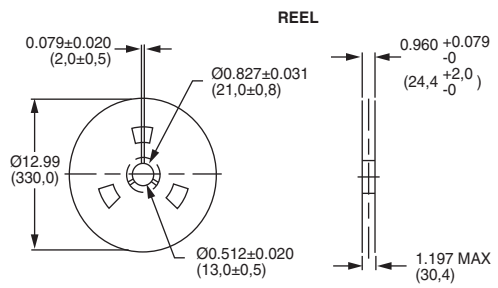
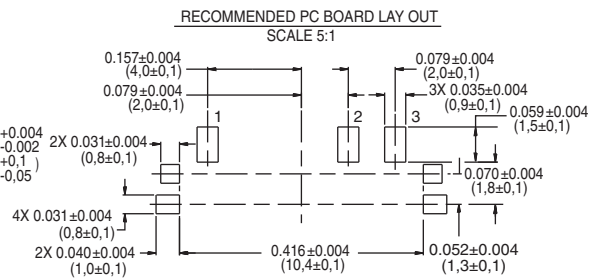
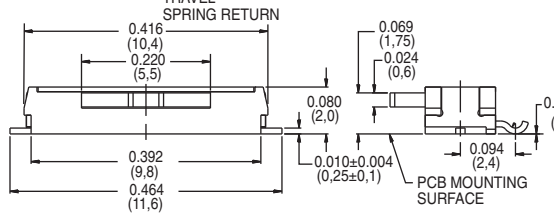
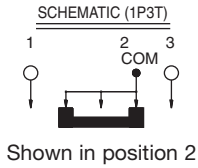
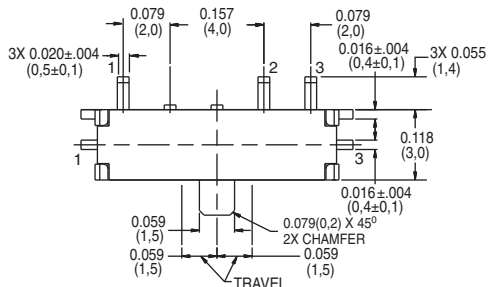

Slide



Dimensions are shown: Inch (mm)
Specifications and dimensions subject to change