

KSB & KSF Series Low-profile Tact Switch



Features/Benefits

- Low profile
- Protected against flux
- KSB without top sealing
- KSF with top sealing
- RoHS compliant and compatible

Typical Applications

- Low profile keyboards
- Instrumentation
- Industrial control
- Medical
- Military

Specification

CONTACT ARRANGEMENT: SPST, N.O.
DOUBLE OVERMOLDING ON TERMINAL
MEMBRANE SEALING
TERMINALS: PC pins

Mechanical

Type	Actuation force Newtons (grams)	Operating life (operations)
KSB0M110	1,2 - 2	100,000
KSB0M410	2,25 - 3,75	500,000
KSF0M210	1.3 (130)	100,000
KSF0M310	1.6 (160)	500,000
KSF0M410	3.0 (300)	100,000
KSF0M510	5.0 (500)	100,000
KSF0M910	3.0 (300)	500,000

NOTE: Specifications listed above are for switches with standard options.
For information on specific and custom switches, consult Customer Service Center.

Electrical

	Silver	Gold
MAXIMUM POWER:	1 VA	0.2 VA
MAXIMUM VOLTAGE:	32 VDC	32 VDC
MINIMUM VOLTAGE:	20 mV	20 mV
MAXIMUM CURRENT:	50 mA	10 mA
MINIMUM CURRENT:	1 mA	1 mA
DIELECTRIC STRENGTH (50 Hz, 1 min.):	300 Vrms	
CONTACT RESISTANCE: KSF 100 m Ω; KSB 100 m Ω		
INSULATION RESISTANCE (100 V):	≤ 10 ⁹ Ω	
BOUNCE TIME:	1 ms	

Environmental

	Silver	Gold
OPERATING TEMPERATURE:	-40°C to 90°C	-40°C to 125°C
STORAGE TEMPERATURE:	-40°C to 90°C	-55°C to 125°C

Process

Wave soldering compatible with lead free soldering profile.

Packaging

KSF can be delivered in tubes of 65 pieces for automatic insertion.
KSB in boxes of 500 pieces for manual insertion.

How To Order

Our easy build-a-switch concept allows you to mix and match options to create the switch you need. To order, select desired option from each category and place it in the appropriate box.

However, please note that all the combinations of these options are not feasible.

For any part number different from those listed above, please consult your local representative.

SWITCH

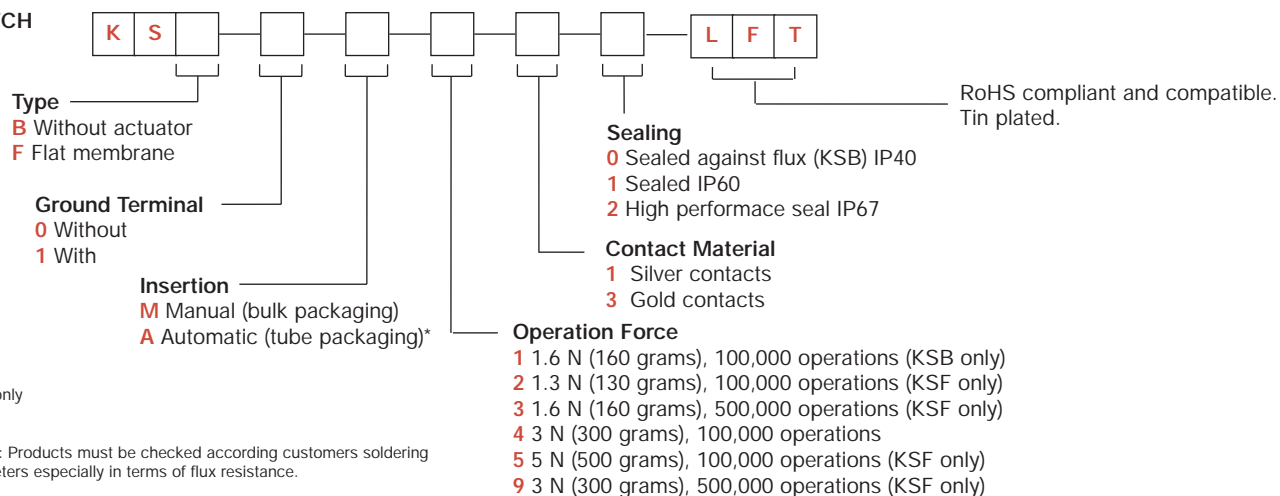

* KSF only

*NOTE: Products must be checked according customers soldering parameters especially in terms of flux resistance.

BUTTON for KSF Button must be ordered separately and will be supplied in bulk.

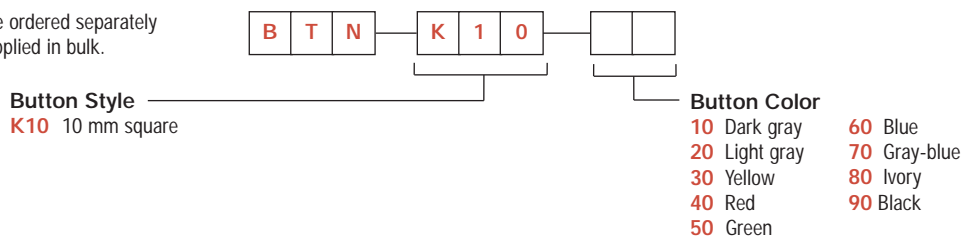

Dimensions shown in: mm (inch)
Specifications and dimensions subject to change

www.ck-components.com

KSB & KSF Series Low-profile Tact Switch

KSB



KSB0M110

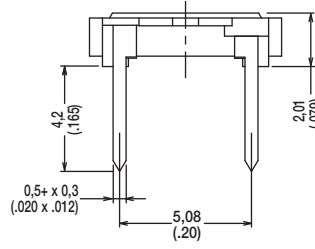
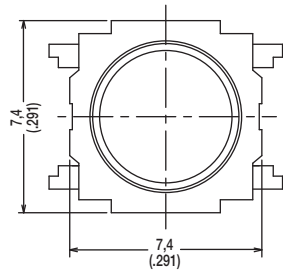
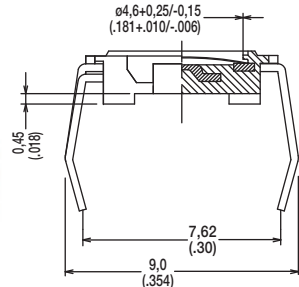

PCB LAYOUT

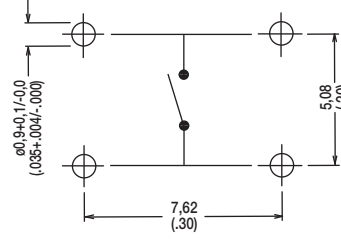

RECOMMENDED SHAPE OF ACTUATOR

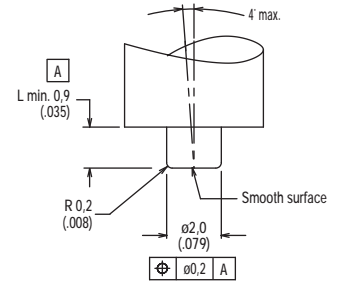

KSF

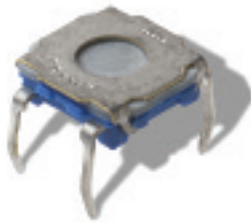

KSF0M111

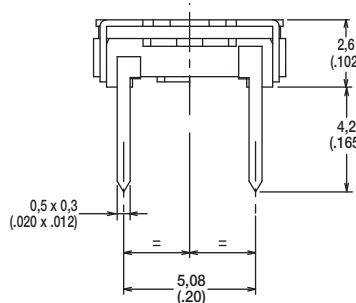
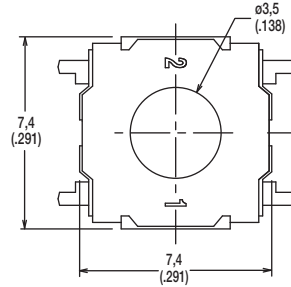
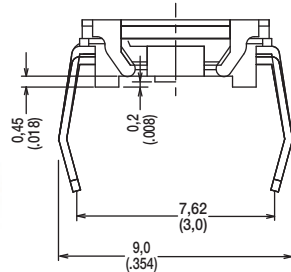

PCB LAYOUT

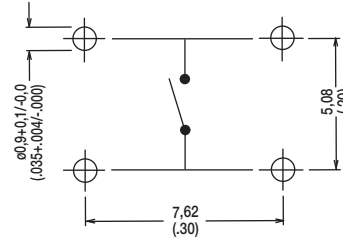

RECOMMENDED SHAPE OF ACTUATOR

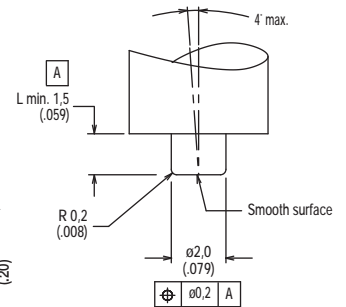

BUTTON

K10 BUTTON FOR KSF ONLY Button must be ordered separately and will be supplied in bulk.

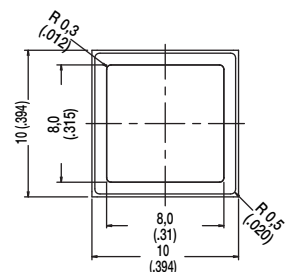
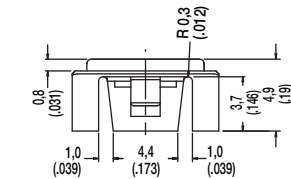
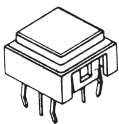

First Angle
Projection

Dimensions shown in: mm (inch)
Specifications and dimensions subject to change