

AYZ Series Miniature Slide Switches



Features/Benefits

- Low profile
- Single & double pole models
- Double & triple throw models
- RoHS compatible

Typical Applications

- Computer peripherals & network products
- Telecommunication products
- Test & measurement equipment



Slide

Specifications

MAX. SWITCHING POWER: 1.2 VA
 MAX. SWITCHING VOLTAGE: 12 VDC
 MAX. SWITCHING CURRENT: 100 mA
 MECHANICAL LIFE: 10,000 operations.
 CONTACT RESISTANCE: <math>< 80\text{m } \Omega</math>
 INSULATION RESISTANCE: >10⁸Ω
 DIELECTRIC STRENGTH: 0.1 kV at 50 Hz/1 min.
 OPERATING TEMPERATURE: -10°C to +60°C
 PACKAGING: Tape & reel, see page J-47.

Materials

HOUSING: Glass filled PPS (UL 94V-0).
 ACTUATOR: Glass filled nylon 6/6 (UL 94V-0), except options ending in C which are glass filled nylon 4/6 (UL94V-0).
 COVER: Nickel silver.
 MOVABLE CONTACT: Copper alloy, silver plated.
 FIXED CONTACT: Brass, silver plated.
 CONTACT SPRING: Contact bronze.

NOTE: Specifications and materials listed above are for switches with standard options. For information on specific and custom switches, consult Customer Service Center.

How To Order

Complete part numbers for AYZ Series Miniature Slide Switches are shown on pages J-46 through J-48.

PC MOUNTING

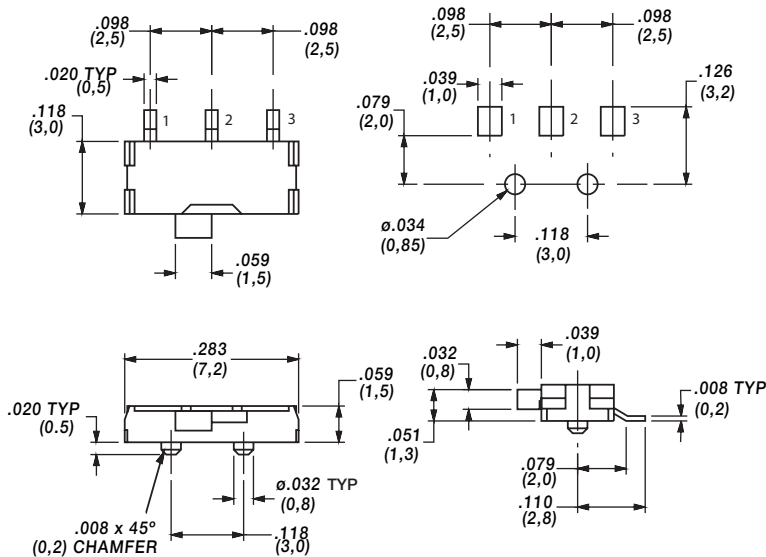

SWITCH SHOWN IN POSITION 1

PART NUMBER	SWITCH FUNCTION		POS.1	POS.2
	RoHS Compliant	RoHS Compatible		
AYZ0102AGRLC	YES	YES	ON	ON
CONN. TERMINALS			1-2	2-3
SCHEMATIC				
SPDT				



Dimensions are shown: Inch (mm)
 Specifications and dimensions subject to change

AYZ Series Miniature Slide Switches

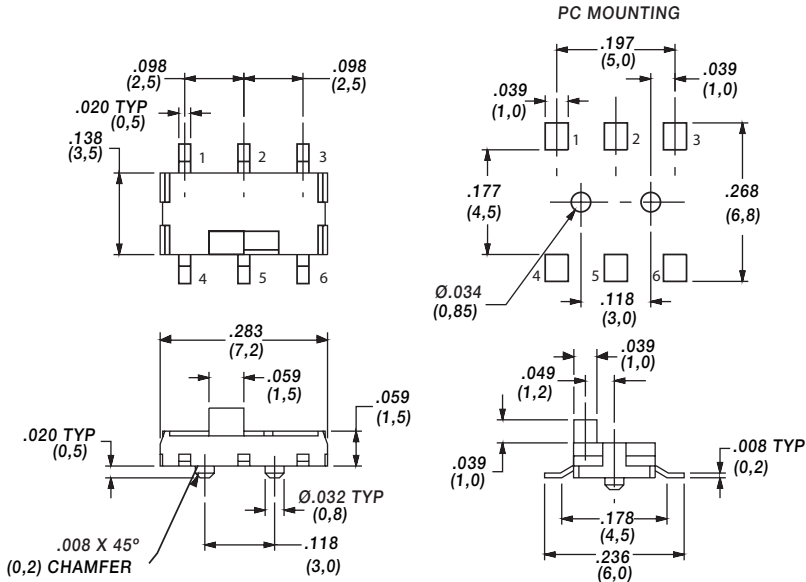

PART NUMBER	RoHS Compliant	RoHS Compatible	SWITCH FUNCTION	
			POS.1	POS.2
AYZ0202AGRLC	YES	YES		
CONN. TERMINALS			1-2,4-5	2-3,5-6
SCHEMATIC				
DPDT				

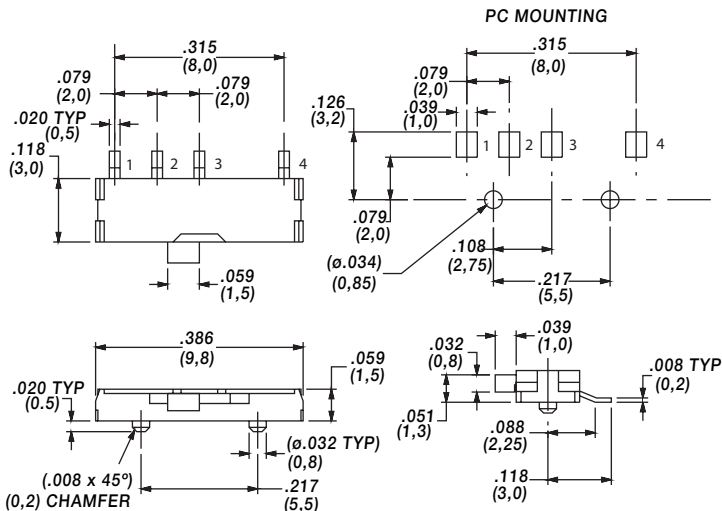

PART NUMBER	ROHS Compliant	ROHS Compatible	SWITCH FUNCTION		
			POS.1	POS.2	POS.3
AYZ0103AGRLC	YES	YES			
CONN. TERMINALS			1-3	2-C	3-4
SCHEMATIC					
SP3T					

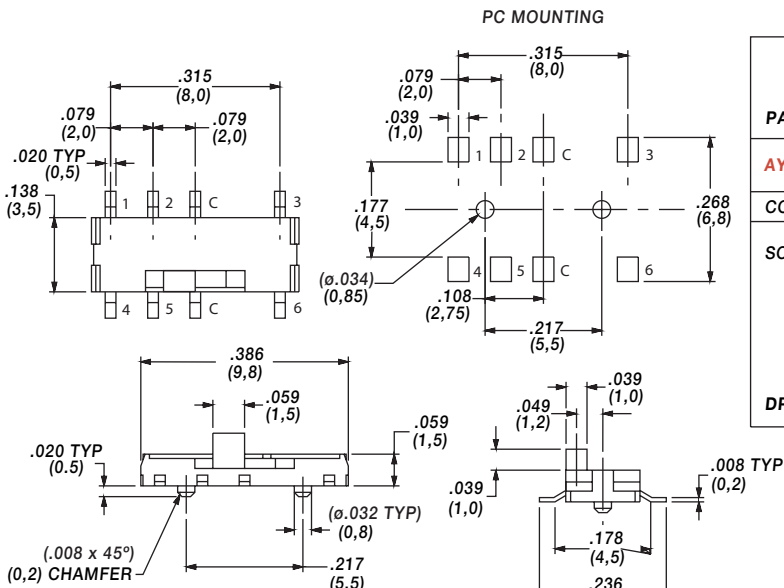

PART NUMBER	ROHS Compliant	ROHS Compatible	SWITCH FUNCTION		
			POS.1	POS.2	POS.3
AYZ0203AGRLC	YES	YES			
CONN. TERMINALS			1-C,4-C	2-C,5-C	3-C,6-C
SCHEMATIC					
DP3T					



Dimensions are shown: Inch (mm)
Specifications and dimensions subject to change



Slide

AYZ Series Miniature Slide Switches

TAPE & REEL

For part number AYZ0102AGRLC

Quantity per reel 4000

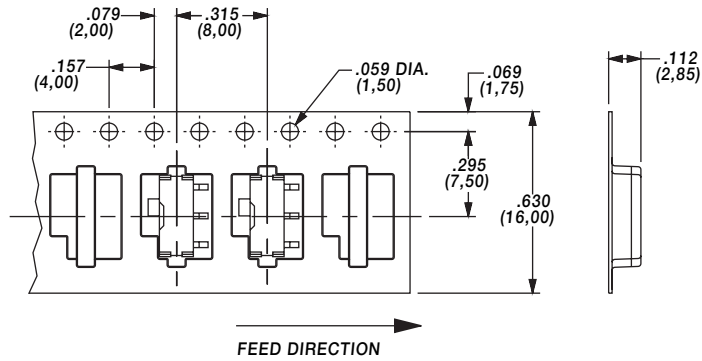

For part number AYZ0103AGRLC

Quantity per reel 4000

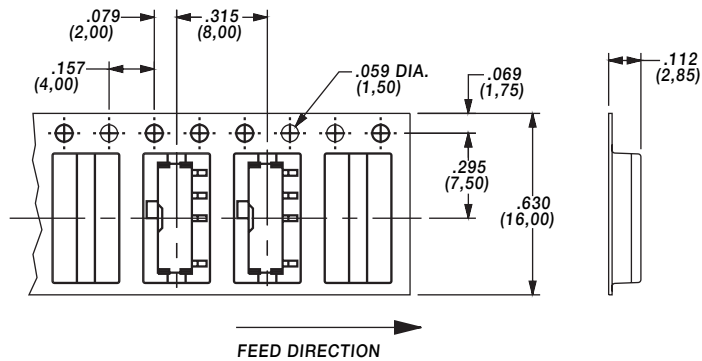

For part number AYZ0202AGRLC

Quantity per reel 3000

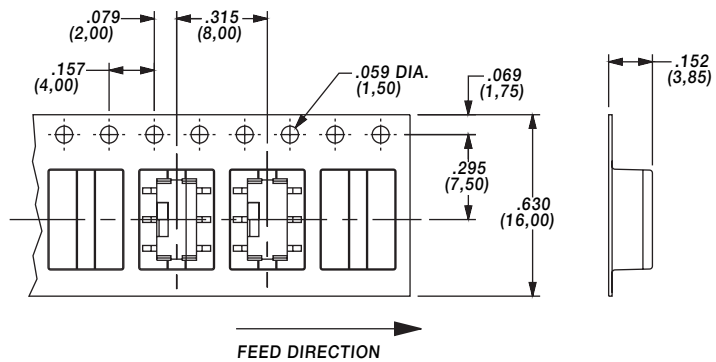

For part number AYZ0203AGRLC

Quantity per reel 3000

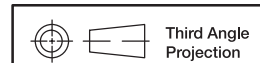
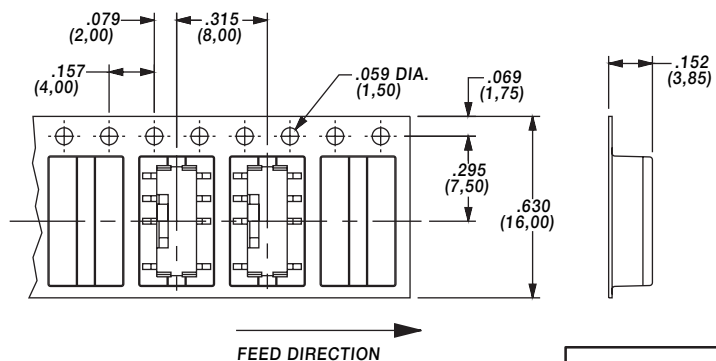

Dimensions are shown: Inch (mm)
Specifications and dimensions subject to change

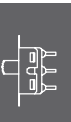

Slide