

RAFIX 22 FS selector switch, illuminated, round collar
1.30.252.002/2200

Other handle marking colours available on request.

General information

Actuator	handle
Form of collar	round
Marking of handle	translucent white
Colour of front ring	metallized

Dimensions

Overall height	22.24 mm
Width of collar	---
Diameter of collar	29.8 mm
Length of collar	---
Mounting depth	9.2 mm
Mounting hole	22.3 mm
Key grid	30 x 30 mm

Mechanical characteristics

Torque max.	1.5 Nm
-------------	--------

Mechanical design

Mounting	ring nut
Illuminability	yes
Rotating angle	1 x 40°
Contact function	momentary

Other specifications

Ambient temp. operating max.	+70 °C
Ambient temp. operating min.	-25 °C
Resistance to constant environment	IEC 600 68-2-3 and 2-30
Storage temperature max.	+80 °C
Storage temperature min.	-40 °C
Operating life	0.5 million momentary /0.5 million latching
Salt spray	IEC 600 68-2-11
Degree of protection from front side	IP65
Resistance at variable environment	IEC 600 68-2-14 and 2-33

16.07.2008

MASS

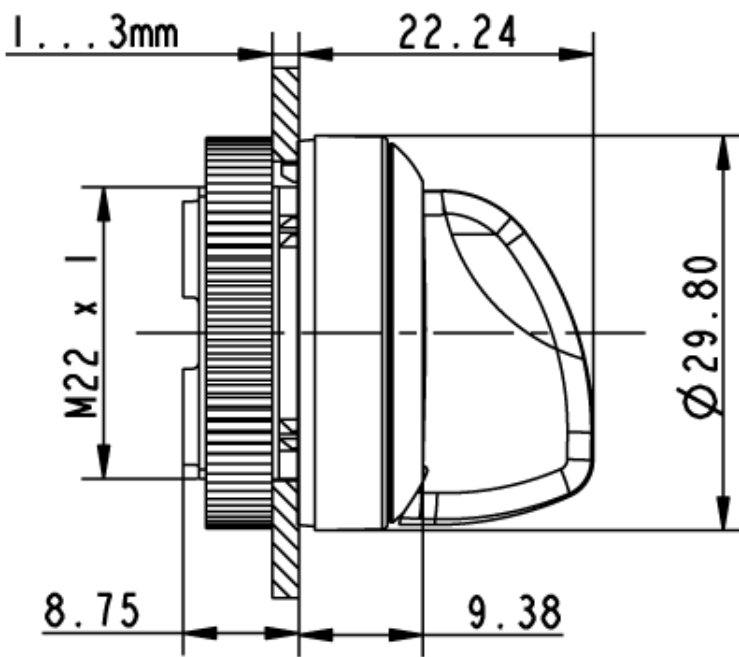

Schaltw

