

INTRODUCTION:

Adam Tech RS Series .100" Receptacle Strips are a series of sockets offered in a multitude of sizes and profiles designed to satisfy most .100" socket requirements. Available in Single, Dual and Three rows, they are offered in Straight, Right Angle, SMT, Bottom Entry and Pass Through PCB mounting styles. Each type has a specially designed contact system which uses a wiping mating action and produces a high normal force connection with gold, tin or selective gold plating. All are available with Standard or Hi-Temp Thermoplastic insulators. Our SMT offering is available with optional pick and place pads and tape & reel packaging.

FEATURES:

- Broad range of sizes and profiles
- Contact systems with high normal force
- Choice of contact plating
- SMT pick & place option
- Optional Tape & reel packaging

MATING CONNECTORS:

Adam Tech PH series .100" pitch pin headers and all industry standard pin headers with a .025" (0.64mm) square pin.

SPECIFICATIONS:

Material:

Insulator: PBT, glass reinforced, rated UL94V-0
Optional Hi-Temp insulator: Nylon 6T, rated UL94V-0
Insulator Color: Black
Contacts: Phosphor Bronze

Contact Plating:

G = Gold flash (30u" optional) over nickel underplate overall
SG = Gold flash (30u" optional) over nickel underplate on contact area, tin over copper underplate on tails.
T = Tin over copper underplate overall

Electrical:

Operating voltage: 250V AC max.
Current rating: 3 Amps max.
Contact resistance: 20 mΩ max. initial
Insulation resistance: 5000 MΩ min.
Dielectric withstanding voltage: 1000V AC for 1 minute

Mechanical:

Insertion force: 0.375 lbs per contact max.
Withdrawal force: 0.125 lbs per contact min.

Temperature Rating:

Operating temperature: -40°C to +105°C

PACKAGING:

Anti-ESD plastic trays
(Tape and Reel optional for SMT option)

SAFETY AGENCY APPROVALS:

UL Recognized File No. E224053
CSA Certified File No. LR1578596

HI-TEMP
INSULATOR
AVAILABLE



ORDERING INFORMATION

RS1

31

G

SERIES INDICATOR

RS1 = Single row vertical mount receptacle
RS1R = Single row right angle mount receptacle
RS2 = Dual row vertical mount receptacle
RS2R = Dual row right angle mount receptacle
RSB = Dual row straight PCB mount with polarization bump and keyed corner contacts
RSBR = Dual row right angle PCB mount with polarization bump and keyed corner contacts
RSE1 = Single row elevated receptacle
RSE2 = Dual row elevated receptacle
RSM1 = Single row surface mount
RSM2 = Dual row surface mount

PLATING

G = Gold plated
T = Tin plated
SG = Gold plating in contact area, Tin Plated solder tails

POSITIONS

Single row: 1 thru 40
Dual row: 2 thru 80

OPTIONS:

Add designator(s) to end of part number
SMT = SMT Dual row with Hi-Temp insulator
SMT-A = SMT Single Row Type A with Hi-Temp insulator
SMT-B = SMT Single Row Type B with Hi-Temp insulator
30 = 30 μin gold plating in contact area
P = Optional guide peg on SMT version
HT = Hi-Temp insulator for Hi-Temp soldering processes up to 260°C (Add this option for thru-hole products only.
All SMT products are manufactured with Hi-Temp insulators)

RECEPTACLE STRIPS FOUR SIDED CONTACT PAGE 299 & 304

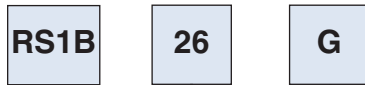

SERIES INDICATOR

RS1B = Single row, vertical mount 4-sided contact receptacle strip
RS2B = Dual row, vertical mount 4-sided contact receptacle strip
RS1BR = Single row, right angle mount, 3-sided contact receptacle strip
RS2BR = Dual row, right angle mount, 3-sided contact receptacle strip

PLATING

G = Gold plated
T = Tin plated
SG = Gold plated contact area, tin plated solder tails

POSITIONS

Single row: 2 thru 40
Dual row: 4 thru 80

RECEPTACLE STRIPS LOW PROFILE PAGE 303



SERIES INDICATOR

RS1L = Single row, .224" body height
RS2L = Dual row, .224" body height

PLATING

G = Gold plated
T = Tin plated

POSITIONS

Single row: 2 thru 80
Dual row: 4 thru 80

RECEPTACLE STRIPS BOTTOM, PASS THROUGH OR DUAL ENTRY PAGE 305 & 306



SERIES INDICATOR

RS1BE = Single row, vertical mount, bottom, pass through or dual entry receptacle strip
RS2BE = Dual row, vertical mount, bottom, pass through or dual entry receptacle strip
RS2BE-A = Dual row, with single sided footprint, vertical mount, bottom, pass through or dual entry receptacle strip

PLATING

G = Gold plated

POSITIONS

Single Row: 2 thru 40
Dual Row: 4 Thru 80

SOLDER TAIL FOOTPRINT

A = .100" x .150"
B = .100" x .200"
C = .100" x .300"
Blank = Single row

RECEPTACLE STRIPS VERY LOW PROFILE PAGE 298



SERIES INDICATOR

RSVL = Vertical Mount, very low profile receptacle strip

PLATING

G = Gold plated
T = Tin plated

PROFILE / NO. OF ROWS

1A = Single row, .138" body height
1B = Single row, .205" body height
2A = Dual row, .138" body height
2B = Dual row, .205" body height

POSITIONS

Single Row: 2 Thru 36
Dual Row: 4 Thru 72

OPTIONS:

Add designator(s) to end of part number

A = Type A PCB Layout

B = Type B PCB Layout

Ordering Information pg. 301

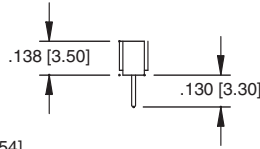
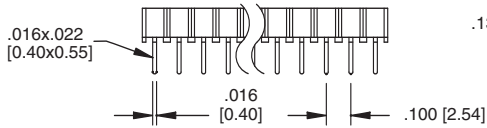
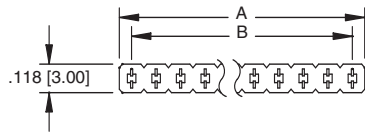

A = .100 [2.54] X No. of Positions
B = .100 [2.54] X No. of Spaces



RSVL-1A

RSVL-1A-18-G

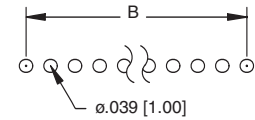

Recommended PCB Layout

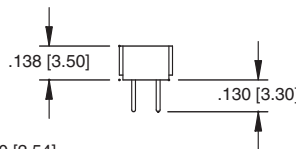
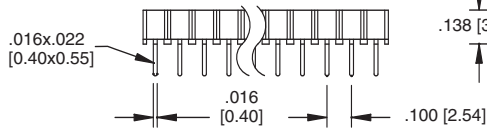
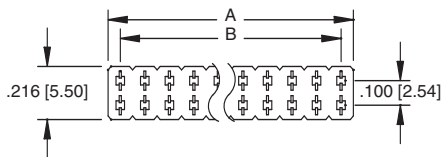

A = .100 [2.54] X No. of Positions Per Row
B = .100 [2.54] X No. of Spaces

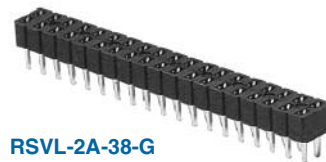

RSVL-2A

RSVL-2A-38-G

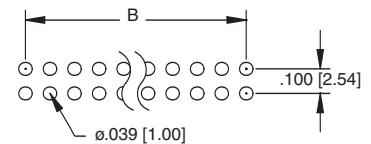

Recommended PCB Layout

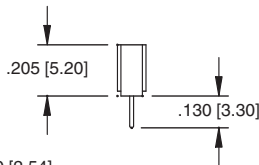
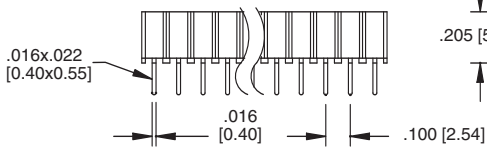
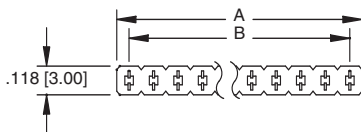

A = .100 [2.54] X No. of Positions
B = .100 [2.54] X No. of Spaces



RSVL-1B

RSVL-1B-18-G

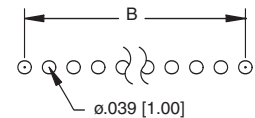

Recommended PCB Layout

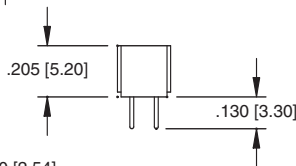
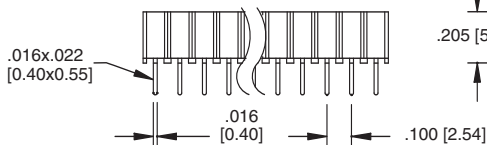
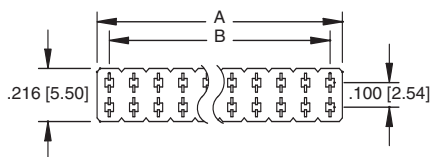

A = .100 [2.54] X No. of Positions Per Row
B = .100 [2.54] X No. of Spaces



RSVL-2B

RSVL-2B-36-G

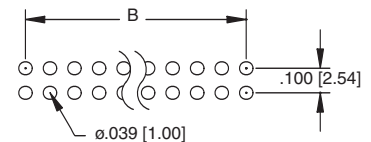

Recommended PCB Layout

Ordering Information pg. 300

RS1

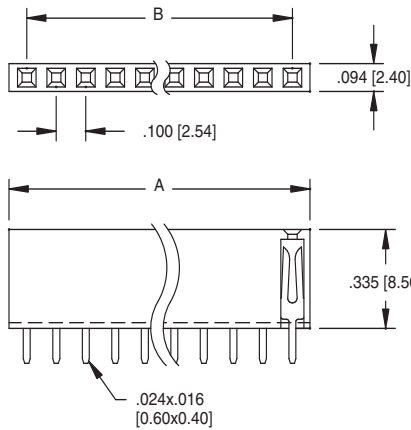

A = .100 [2.54] X No. of Positions + .020 [0.50]
 B = .100 [2.54] X No. of Spaces

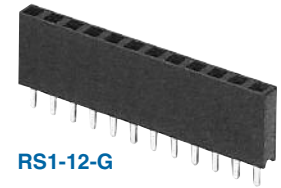

RS1-12-G

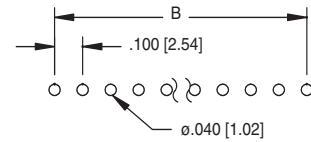
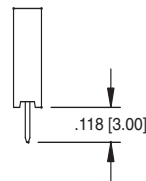

Recommended PCB Layout

RS1R

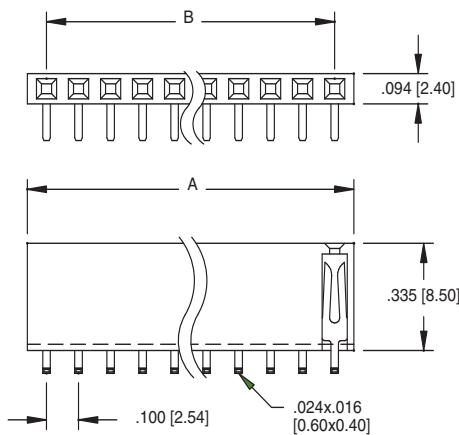

A = .100 [2.54] X No. of Positions + .020 [0.50]
 B = .100 [2.54] X No. of Spaces

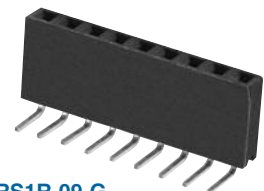

RS1R-09-G

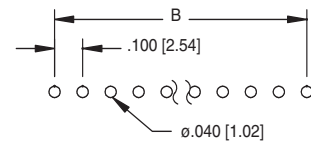
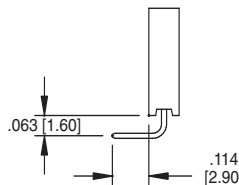

Recommended PCB Layout

RS1BR

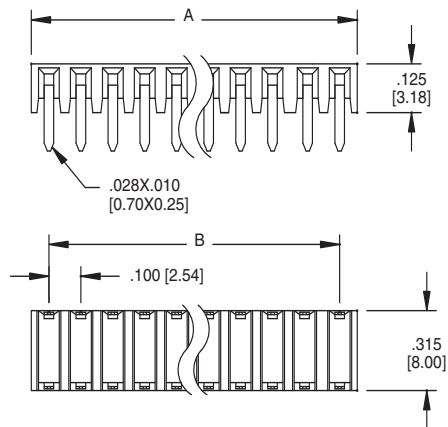

A = .100 [2.54] X No. of Positions
 B = .100 [2.54] X No. of Spaces

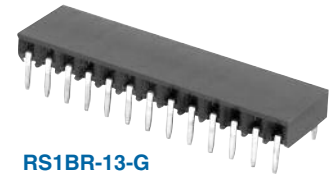

RS1BR-13-G

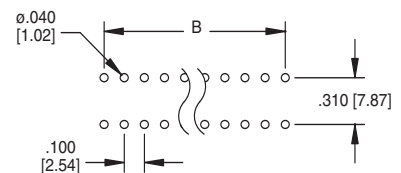
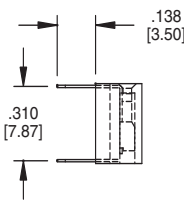

Recommended PCB Layout

Ordering Information pg. 300

RS2

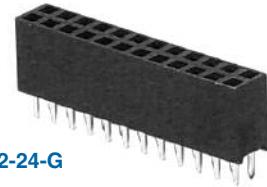
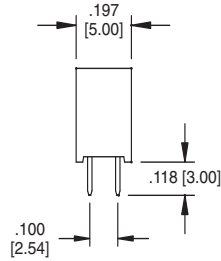
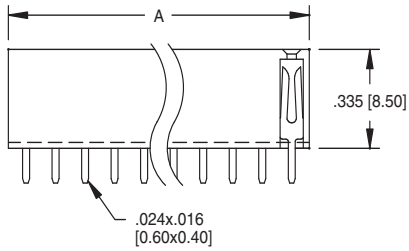
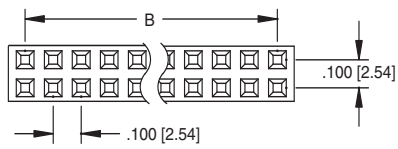

RS2-24-G

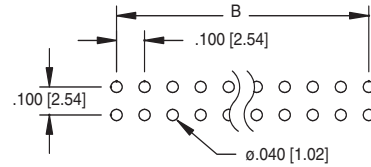

Recommended PCB Layout

A = .100 [2.54] X No. of Positions per row +.020 [0.50]
B = .100 [2.54] X No. of Spaces

RS2R

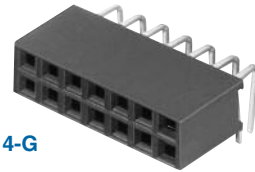
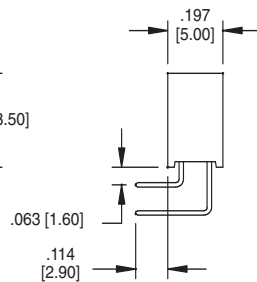
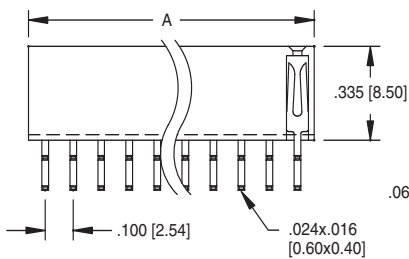
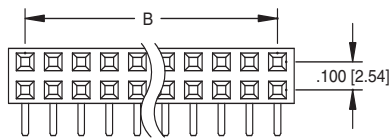

RS2R-14-G

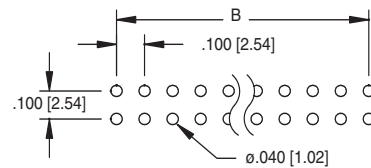

Recommended PCB Layout

A = .100 [2.54] X No. of Positions per row +.020 [0.50]
B = .100 [2.54] X No. of Spaces

RS2BR

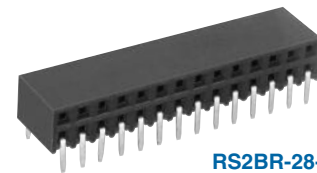
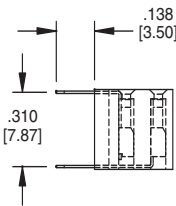
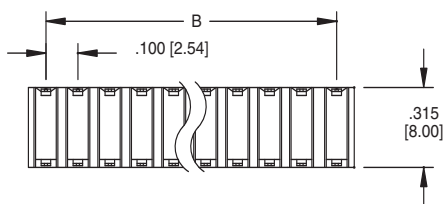
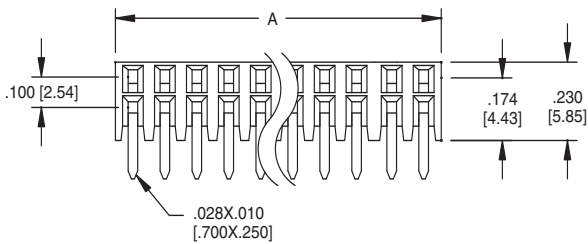

RS2BR-28-G

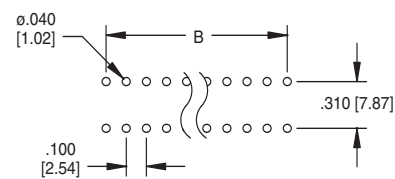

Recommended PCB Layout

A = .100 [2.54] X No. of Positions per row
B = .100 [2.54] X No. of Spaces

Ordering Information pg. 300

RSM1

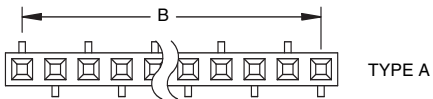
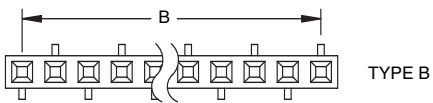

RSM1-10-SG-SMT-A

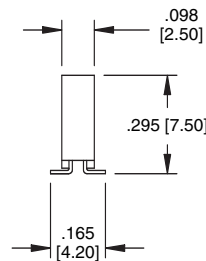
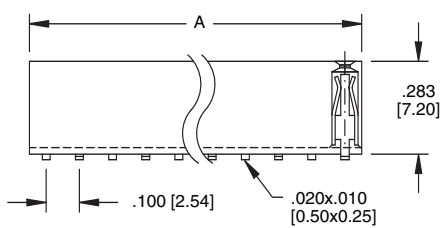

A = .100 [2.54] X No. of Positions
B = .100 [2.54] X No. of Spaces

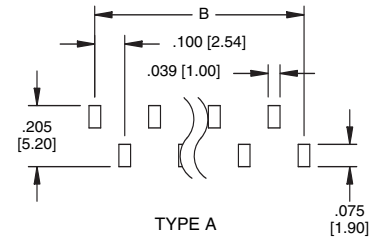

Recommended PCB Layout

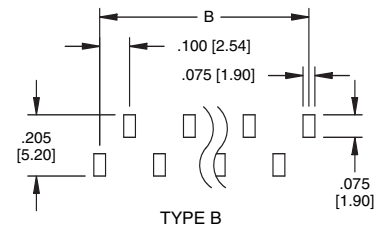

Recommended PCB Layout

RSM2

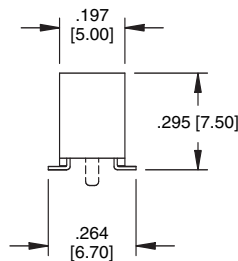
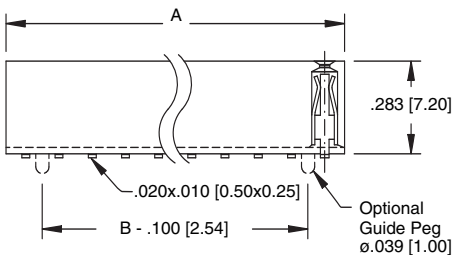
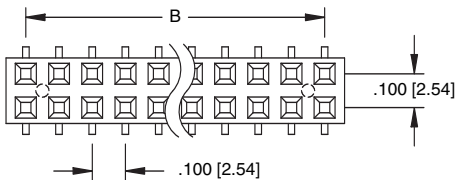

A = .100 [2.54] X No. of Positions per row
B = .100 [2.54] X No. of Spaces



RSM2-20-SG-SMT

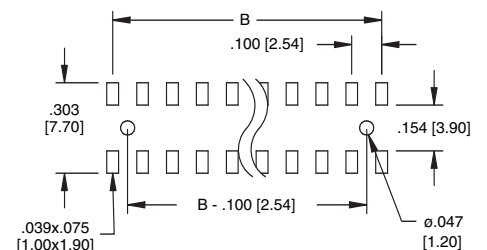

Recommended PCB Layout

Ordering Information pg. 300

RSB

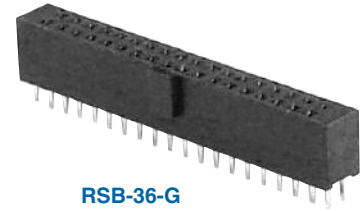
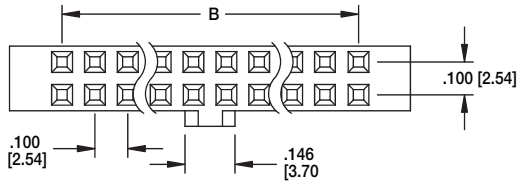

RSB-36-G

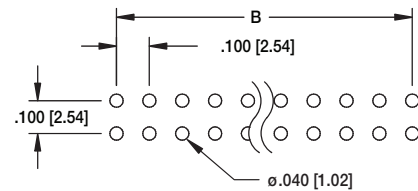
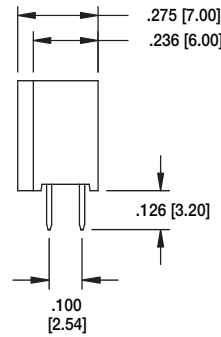
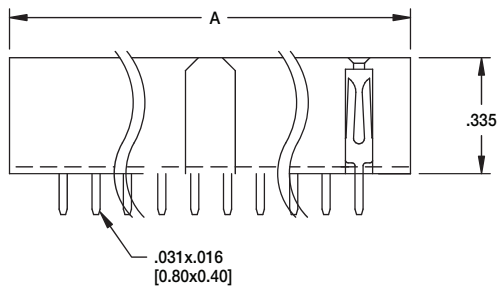

Recommended PCB Layout

A = .100 [2.54] X No. of Spaces + .300 [7.62]
 B = .100 [2.54] X No. of Spaces

RSBR

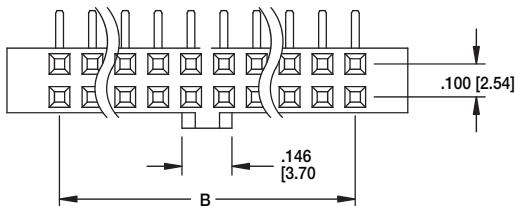

RSBR-36-G

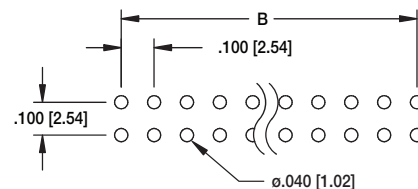
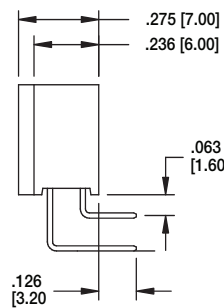
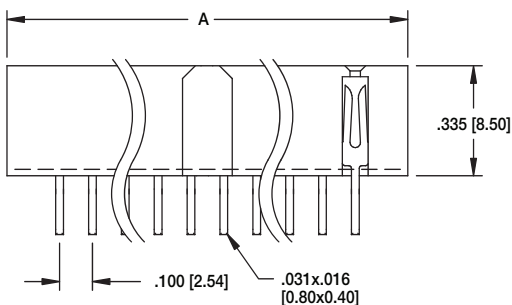

Recommended PCB Layout

A = .100 [2.54] X No. of Spaces + .300 [7.62]
 B = .100 [2.54] X No. of Spaces

RS1L

Ordering Information pg. 301

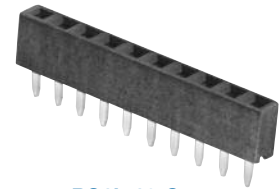
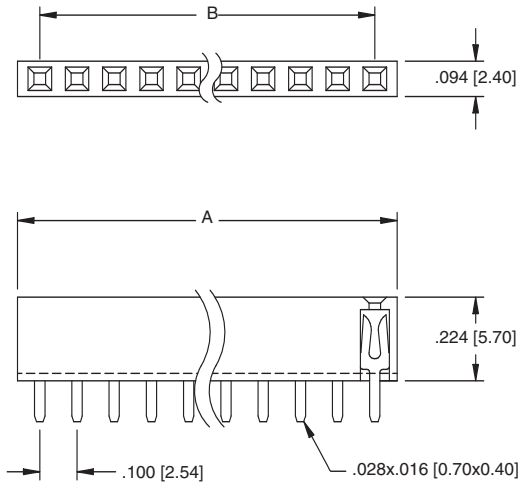

RS1L-10-G

A = .100 [2.54] X No. of Positions
B = .100 [2.54] X No. of Spaces

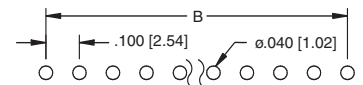

Recommended PCB Layout

RS2L

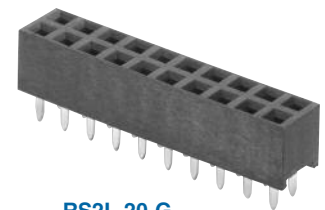
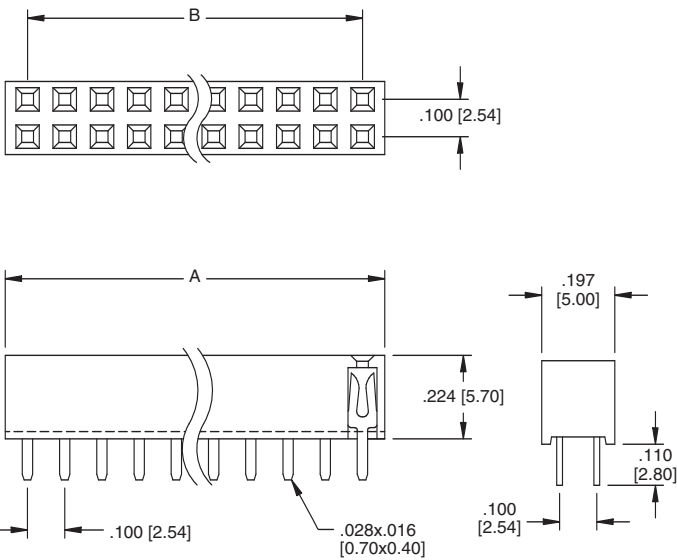

RS2L-20-G

A = .100 [2.54] X No. of Positions per row
B = .100 [2.54] X No. of Spaces

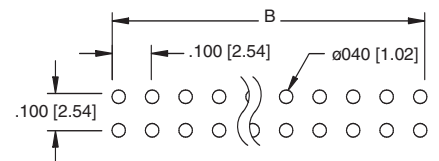

Recommended PCB Layout

Ordering Information pg. 301

RS1B

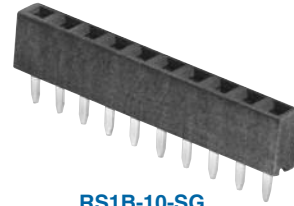
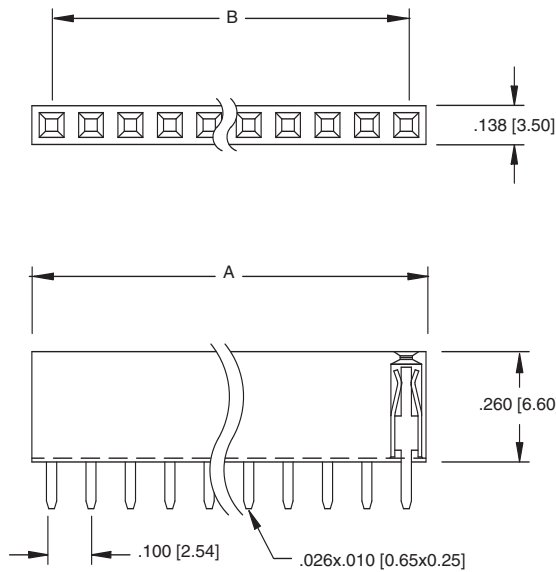

RS1B-10-SG

A = .100 [2.54] X No. of Positions
B = .100 [2.54] X No. of Spaces

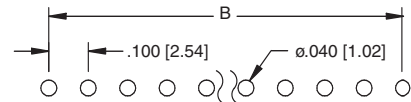

Recommended PCB Layout

RS2B

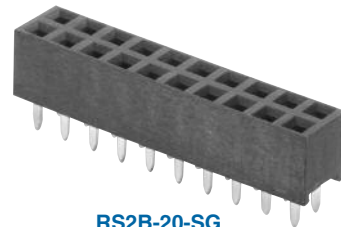
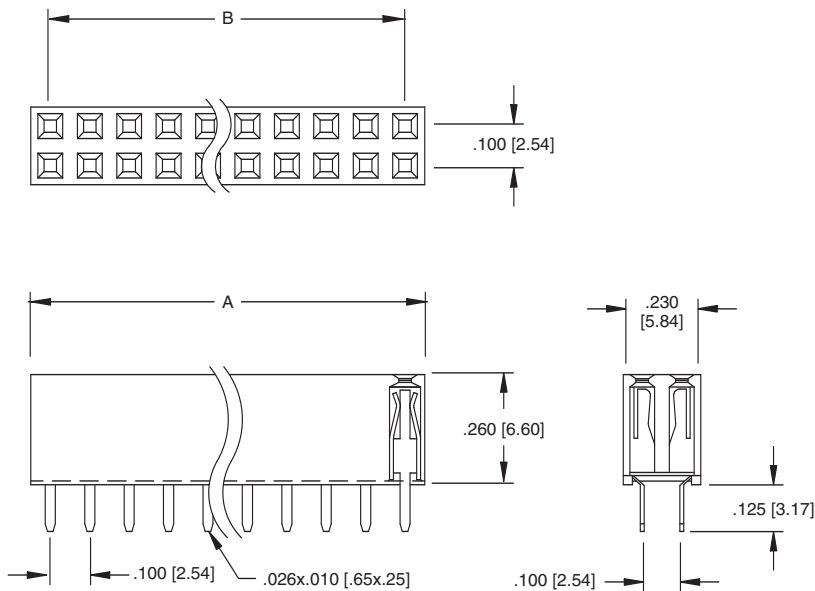

RS2B-20-SG

A = .100 [2.54] X No. of Positions per row
B = .100 [2.54] X No. of Spaces

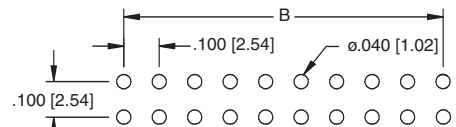

Recommended PCB Layout

Ordering Information pg. 301

RS1BE-A/B

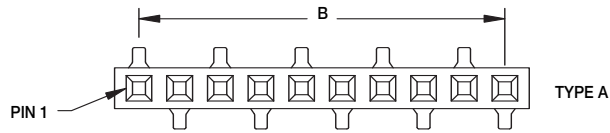
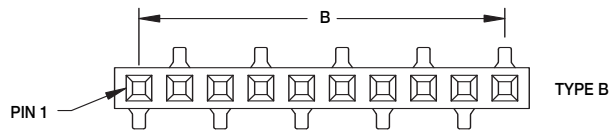

RS1BE-B-10-SG-A

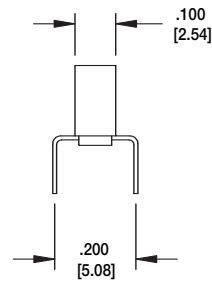
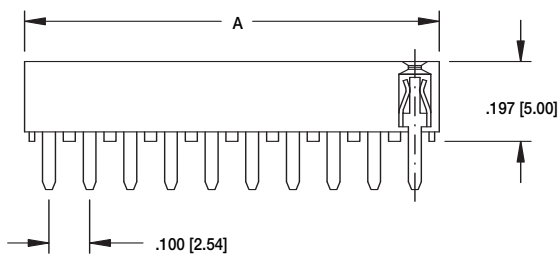

A = .100 [2.54] X No. of Positions
B = .100 [2.54] X No. of Spaces

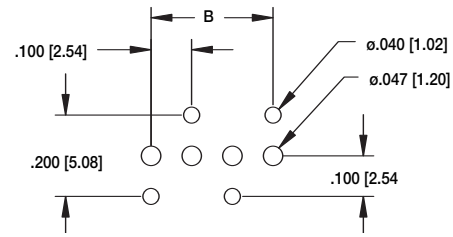
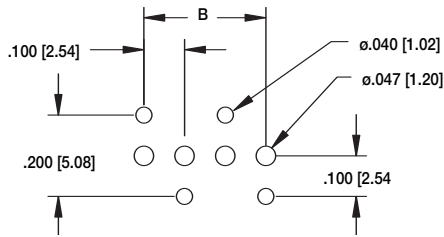

TYPE A

TYPE B

Recommended PCB Layouts

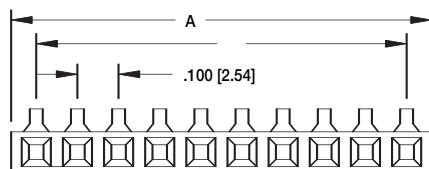

A = .100 [2.54] X No. of Positions
B = .100 [2.54] X No. of Spaces



RS1BE-10-SG

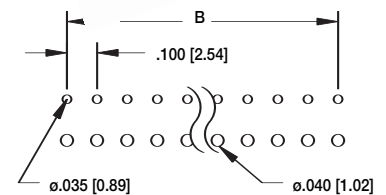
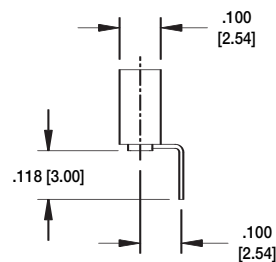
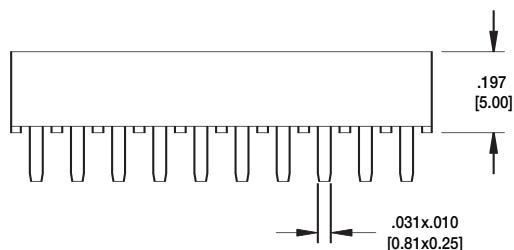

Recommended PCB Layout

Ordering Information pg. 301

RS2BE-A

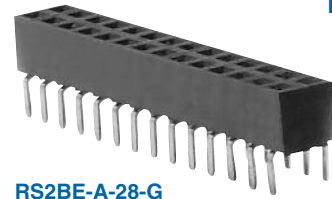
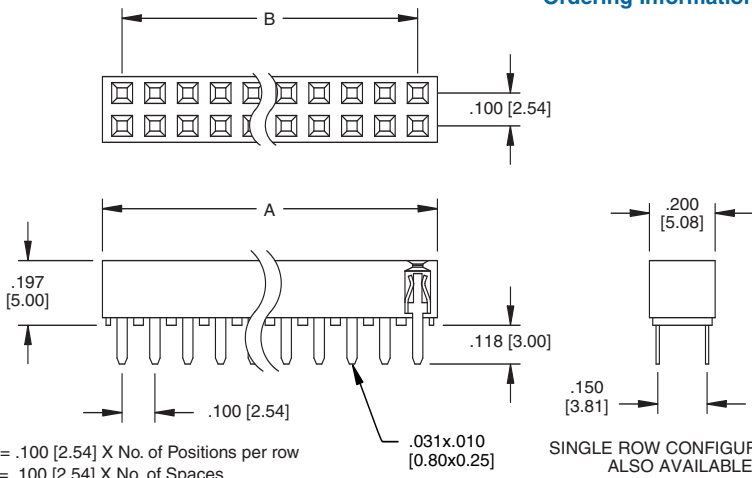

RS2BE-A-28-G

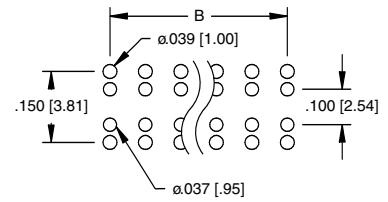

Recommended PCB Layout

RS2BE-B

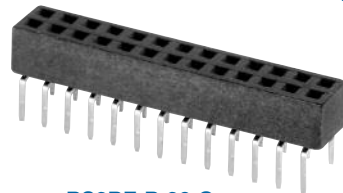
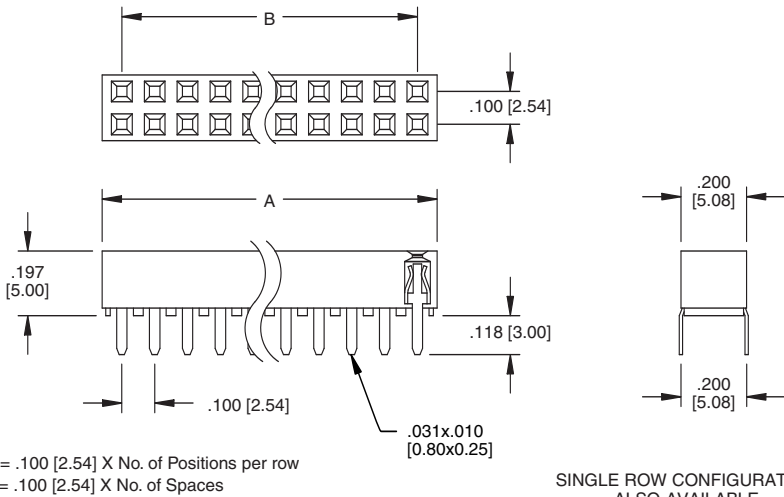

RS2BE-B-26-G

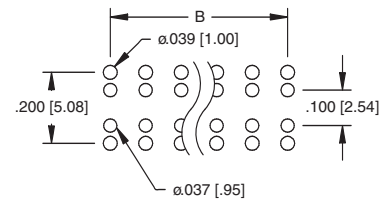

Recommended PCB Layout

RS2BE-C

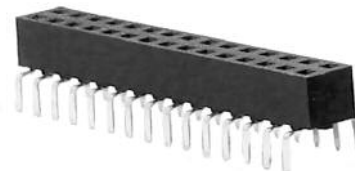
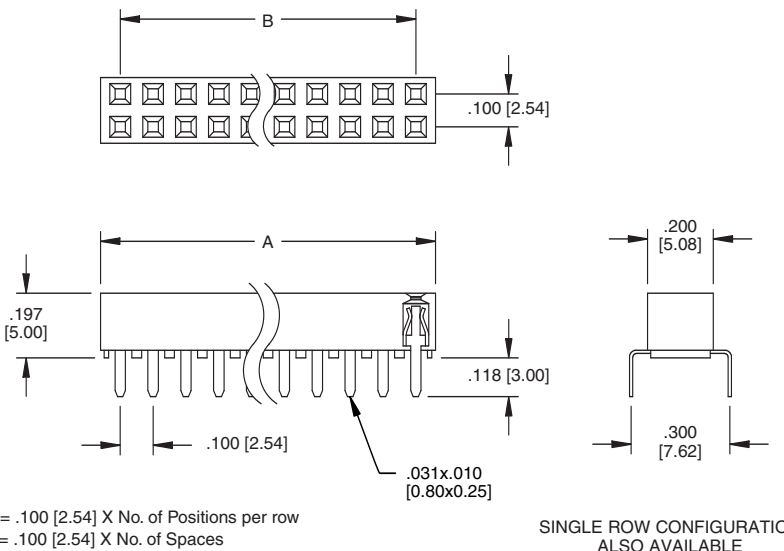

RS2BE-C-30-G

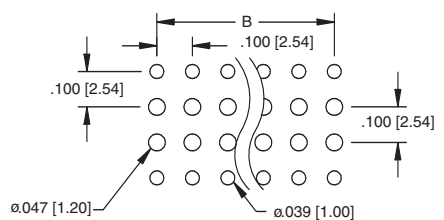

Recommended PCB Layout

$A = .100" [2.54] \times \text{No. of positions}$
 $B = .100" [2.54] \times \text{No. of spaces}$

RSE1

RSE1-3-20-SG-3

Recommended PCB Layout

$A = .100" [2.54] \times \text{No. of positions per row}$
 $B = .100" [2.54] \times \text{No. of spaces}$

RSE2

RSE2-3-40-SG-3

Recommended PCB Layout

ORDERING INFORMATION

RSE1

2

20

SG

1

SERIES INDICATOR
RSE1 = Single row, vertical elevated socket strip
RSE2 = Dual row, vertical elevated socket strip

POSITIONS
Single Row 01 thru 40
Dual Row 02 thru 80

PLATING
SG = Selective Gold Plating in contact area, Tin Plated tails
T = Tin Plated

HEIGHT
1 = .433 [11.00]
2 = .531 [13.50]
3 = .630 [16.00]

PIN LENGTH
Dim. D
 See chart Dim.D

1 Insulator

2 Insulators

3 Insulators

PART NUMBER	INSULATORS	Dim. C	Dim. D
RSE(1-00)SG-1	1	.433 [11.00]	.315 [8.00]
RSE(1-00)SG-2	1	.433 [11.00]	.315 [8.00]
RSE(1-00)SG-3	1	.433 [11.00]	.448 [11.40]
RSE(2-00)SG-1	2	.531 [13.50]	.216 [5.50]
RSE(3-00)SG-1	3	.630 [16.00]	.118 [3.00]
RSE(3-00)SG-2	3	.630 [16.00]	.262 [6.60]