

# AS1374

## 200mA, Ultra-Low-Noise, High-PSRR, Dual Low Dropout Regulators

### 1 General Description

The AS1374 is a ultra-low-noise, low-dropout linear regulator with two separated outputs. Specifically designed to deliver 200mA continuous output current at each output pin. The LDOs can achieve a low 120mV dropout for 200mA load current and are designed and optimized to work with low-cost, small-capacitance ceramic capacitors.

An integrated P-channel MOSFET pass transistor allows the devices to maintain extremely low quiescent current (30µA).

The AS1374 uses an advanced architecture to achieve ultra-low output voltage noise of 20µVRMS and a power-supply rejection-ratio of better than 85dB (@ 1kHz).

Two active-High enable pins allows to switch on or off each output independently from each other.

The AS1374 requires only 1µF output capacitor for stability at any load.

The device is available in a 6-bump WLP package.

### 2 Key Features

- Preset Output Voltages: 1.2 to 3.6V (in 50mV steps)
- Output Noise: 20µVRMS @ 100Hz to 100kHz
- Power-Supply Rejection Ratio: 85dB @ 1kHz
- Low Dropout: 120mV @ 200mA Load
- Stable with 1µF Ceramic Capacitor for any Load
- Guaranteed 200mA Output
- Pull-Down Option in Shutdown (factory set)
- Extremely-Low Quiescent Current: 30µA
- Excellent Load/Line Transient
- Overcurrent and Thermal Protection
- 6-bump WLP Package

### 3 Applications

The devices are ideal for mobile phones, wireless phones, PDAs, handheld computers, mobile phone base stations, Bluetooth portable radios and accessories, wireless LANs, digital cameras, personal audio devices, and any other portable, battery-powered application.

Figure 1. AS1374 - Typical Application Circuit

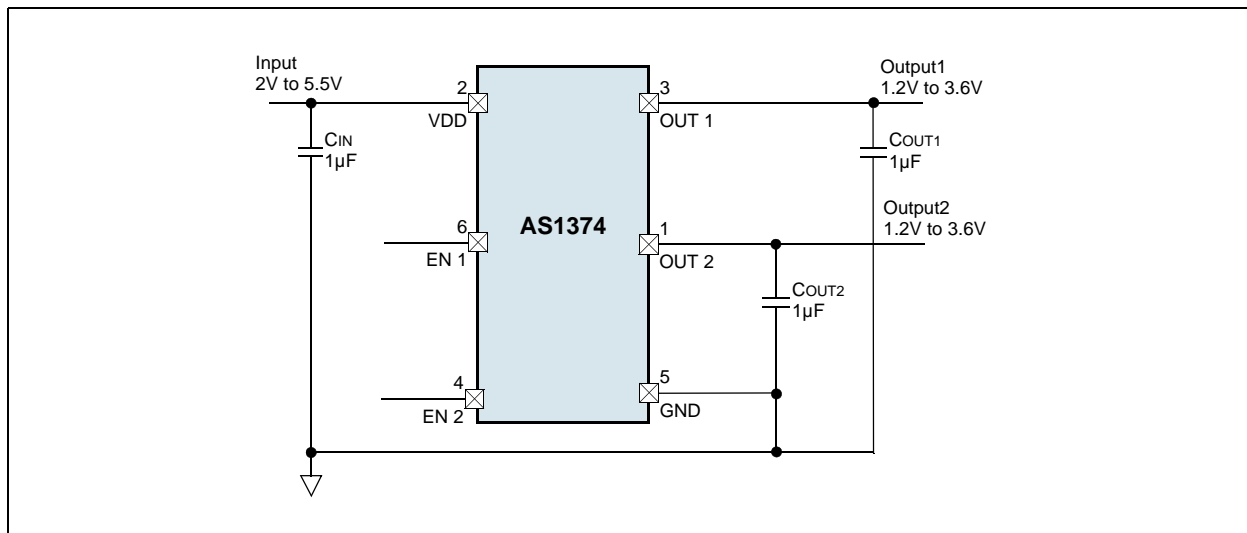

## 4 Pinout

### Pin Assignments

Figure 2. Pin Assignments (Top View)

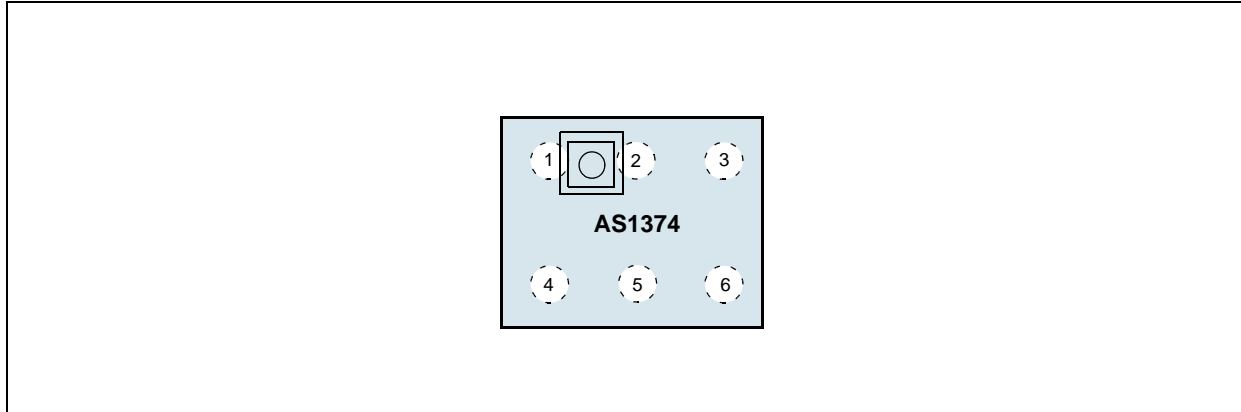

### Pin Descriptions

Table 1. Pin Descriptions

Pin Number	Pin Name	Description
1	OUT 2	<b>Regulated Output Voltage 2.</b> Bypass this pin with a capacitor to GND. See <a href="#">Capacitor Selection and Regulator Stability on page 11</a> for more details.
2	VDD	<b>Input Supply</b>
3	OUT 1	<b>Regulated Output Voltage 1.</b> Bypass this pin with a capacitor to GND. See <a href="#">Capacitor Selection and Regulator Stability on page 11</a> for more details.
4	EN 2	<b>Enable 2.</b> Pull this pin to logic low to disable Regulated Output 2 voltage.
5	GND	<b>Ground</b>
6	EN 1	<b>Enable 1.</b> Pull this pin to logic low to disable Regulated Output 1 voltage.

## 5 Absolute Maximum Ratings

Stresses beyond those listed in [Table 2](#) may cause permanent damage to the device. These are stress ratings only, and functional operation of the device at these or any other conditions beyond those indicated in [Electrical Characteristics on page 4](#) is not implied. Exposure to absolute maximum rating conditions for extended periods may affect device reliability.

Table 2. Absolute Maximum Ratings

Parameter	Min	Max	Units	Comments
VDD to GND	-0.3	+7	V	
OUT 1, OUT 2, EN 1, EN 2 to GND	-0.3	VDD + 0.3	V	
Output Short-Circuit Duration		Infinite		
ESD		2	kV	<i>HBM MIL-Std. 883E 3015.7 methods</i>
Latch-Up		100	mA	<i>@85°C, JEDEC 78</i>
Thermal Resistance $\Theta_{JA}$		201.7	°C/W	on PCB
Operating Temperature Range	-40	+85	°C	
Junction Temperature		+150	°C	
Storage Temperature Range	-65	+150	°C	
Package Body Temperature		+260	°C	The reflow peak soldering temperature (body temperature) specified is in accordance with <i>IPC/JEDEC J-STD-020D "Moisture/Reflow Sensitivity Classification for Non-Hermetic Solid State Surface Mount Devices"</i> . The lead finish for Pb-free leaded packages is matte tin (100% Sn).

## 6 Electrical Characteristics

$V_{IN} = V_{OUT} + 0.5V$ ,  $V_{OUT} = 2.85V$ ,  $C_{IN} = C_{OUT} = 1\mu F$ ,  $T_{AMB} = -40^{\circ}C$  to  $+85^{\circ}C$  (unless otherwise specified). Typ values are at  $T_{AMB} = +25^{\circ}C$ .

Table 3. Electrical Characteristics

Symbol	Parameter	Condition	Min	Typ	Max	Unit
$V_{IN}$	Input Voltage Range		2		5.5	V
$\Delta V_{OUT}$	Output Voltage Accuracy	$I_{OUT} = 1mA$ , $T_{AMB} = +25^{\circ}C$	-1		+1	%
		$I_{OUT} = 100\mu A$ to $200mA$ , $T_{AMB} = +25^{\circ}C$	-1.5		+1.5	
		$I_{OUT} = 100\mu A$ to $200mA$	-2.5		+2.5	
$I_{OUT}$	Maximum Output Current	each channel	200			mA
$I_{GND}$	Ground Current	one channel on, $I_{OUT} = 50\mu A$		25	50	$\mu A$
		one channel on, $I_{OUT} = 200mA$		30	55	$\mu A$
$I_{LIMIT}$	Current Limit	OUT = short	210	300	400	mA
	Dropout Voltage <sup>1</sup>	$2.5V \leq V_{OUT} < 3V$ , $I_{OUT} = 100mA$		60	120	mV
$I_Q$	Quiescent Current	both channels on, $I_{OUT} = 0.05mA$		30	90	$\mu A$
		both channels on, $V_{IN} = V_{OUTNOM} - 0.1V$ , $I_{OUT} = 0mA$		50		
$V_{LNR}$	Line Regulation	$V_{IN} = (V_{OUT} + 0.5V)$ to $5.5V$ , $I_{OUT} = 1mA$		0.02		%/V
$V_{LDR}$	Load Regulation	$I_{OUT} = 1$ to $200mA$		0.0005		%/mA
$I_{SHDN}$	Shutdown Current	OUT 1 and OUT 2 disable		0.01	2	$\mu A$
PSRR	Ripple Rejection	$f = 1kHz$ , $I_{OUT} = 10mA$		85		dB
		$f = 10kHz$ , $I_{OUT} = 10mA$		65		
		$f = 100kHz$ , $I_{OUT} = 10mA$		50		
	Output Noise Voltage (RMS)	$f = 100Hz$ to $100kHz$ , $I_{LOAD} = 20mA$		20		$\mu V$
<b>Enable</b>						
	Enable Input Bias Current			0.01		$\mu A$
	Enable Exit Delay <sup>2</sup>	both channels initially off		150		$\mu s$
		one channel initially off		200		
	Enable Logic Low Level				0.4	V
	Enable Logic High Level		1.4			V
<b>Thermal Protection</b>						
$T_{SHDN}$	Thermal Shutdown Temperature			160		$^{\circ}C$
$\Delta T_{SHDN}$	Thermal Shutdown Hysteresis			15		$^{\circ}C$

1. Dropout is defined as  $V_{IN} - V_{OUT}$  when  $V_{OUT}$  is 100mV below the value of  $V_{OUT}$  for  $V_{IN} = V_{OUT} + 0.5V$ .

2. Time needed for  $V_{OUT}$  to reach 90% of final value.

**Note:** All limits are guaranteed. The parameters with min and max values are guaranteed with production tests or SQC (Statistical Quality Control) methods.

## 7 Typical Operating Characteristics

$V_{IN} = V_{OUT} + 0.5V$ ,  $V_{OUT} = 2.85V$ ,  $C_{IN} = C_{OUT} = 1\mu F$ ,  $T_{AMB} = 25^\circ C$  (unless otherwise specified).

Figure 3. Output Voltage vs. Temperature

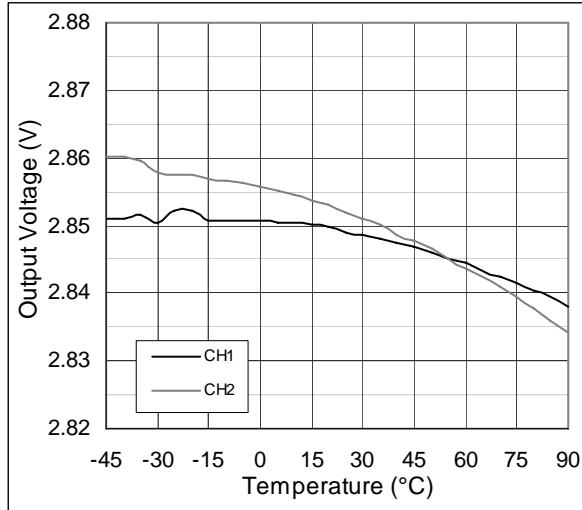

Figure 4. Output Voltage vs. Input Voltage

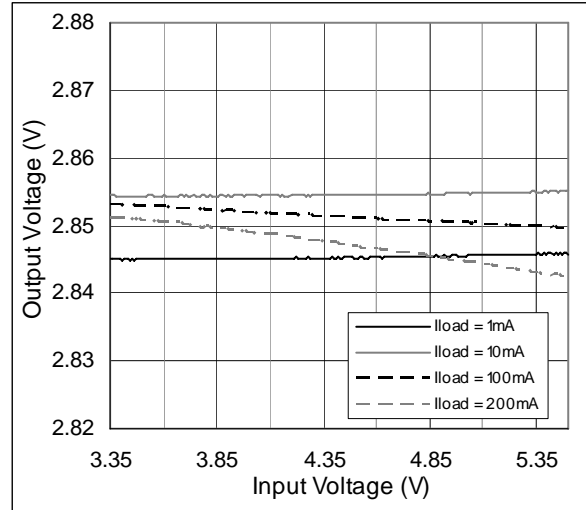

Figure 5. Output Voltage vs. Load Current

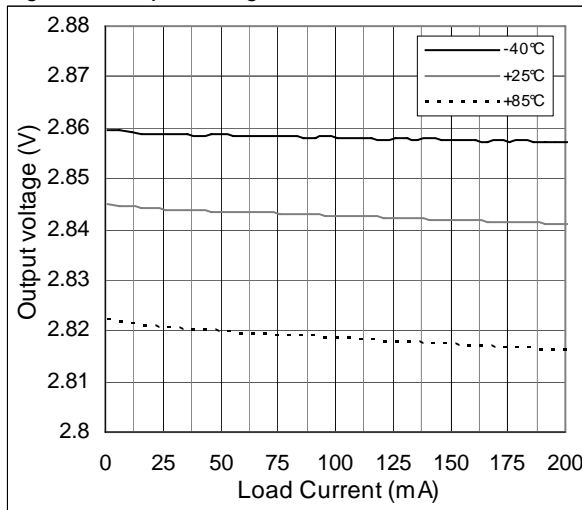

Figure 6. Output Voltage vs. Input Voltage - Dropout

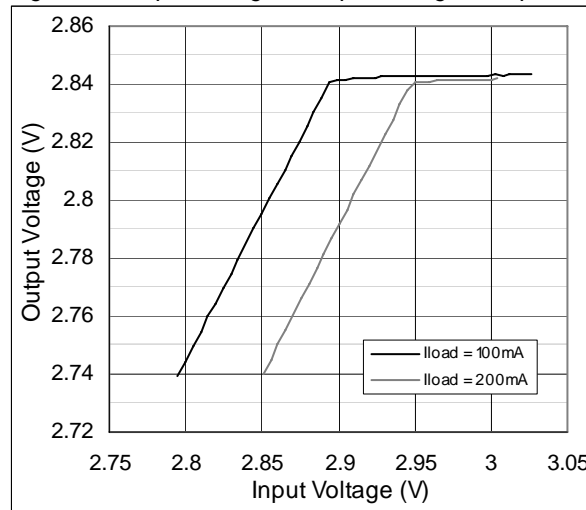

Figure 7. Dropout Voltage vs. Load Current

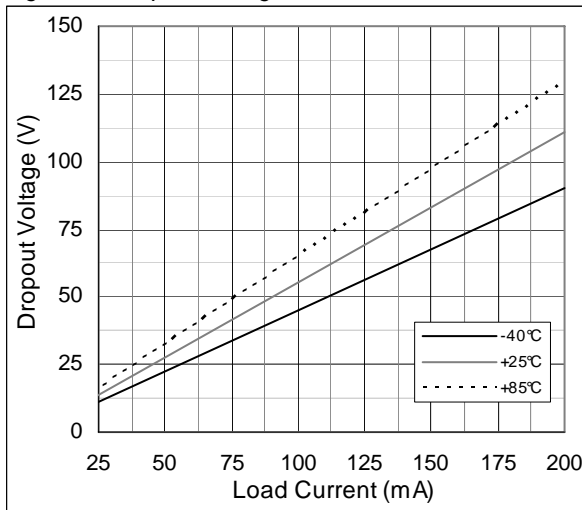

Figure 8. PSRR vs. Frequency

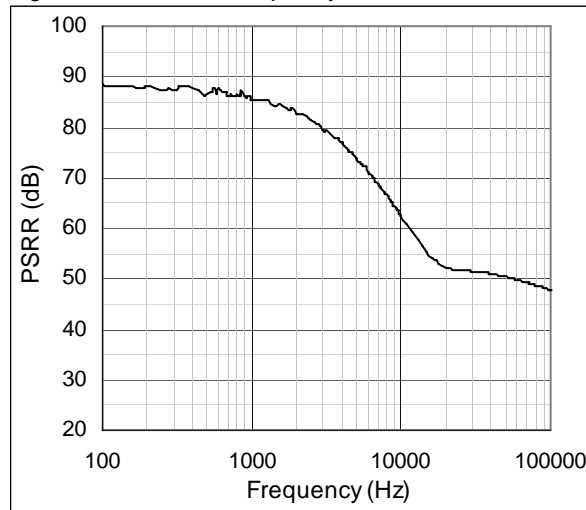

Figure 9. Ground Pin Current vs. Load Current

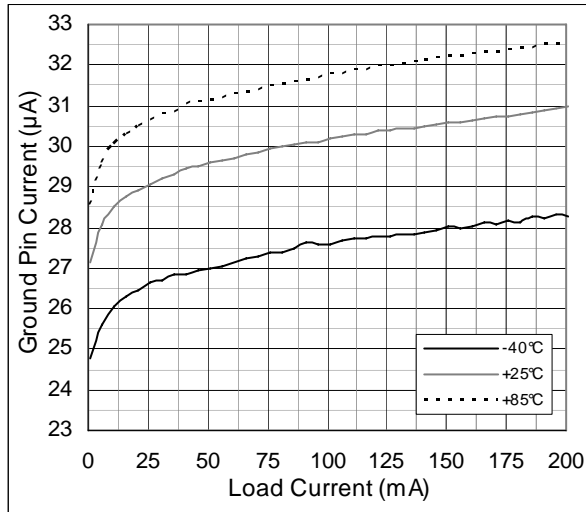

Figure 10. Ground Pin Current vs. Temperature

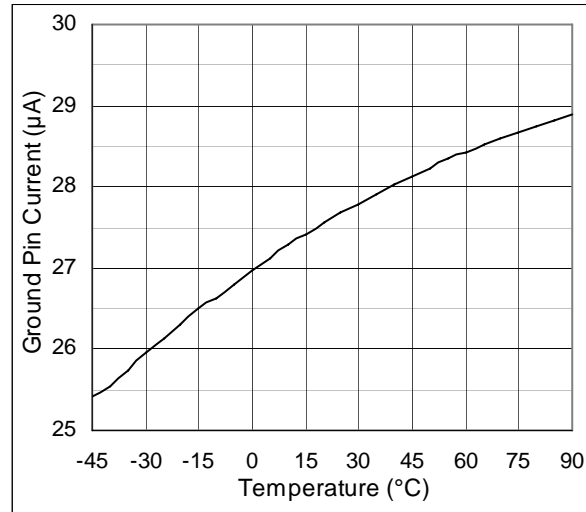

Figure 11. Ground Pin Current vs. Input Voltage; one Channel on, no Load

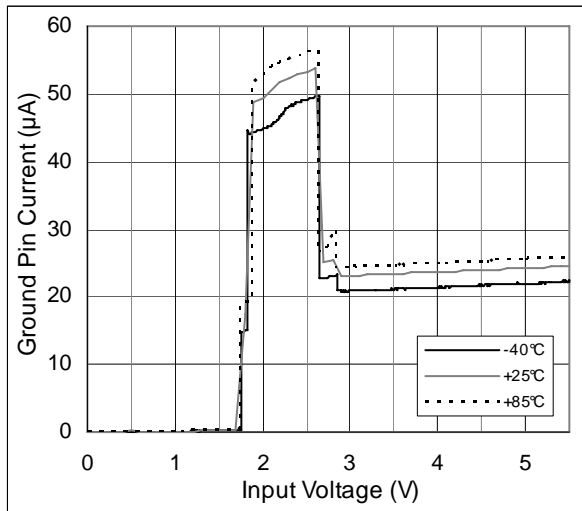

Figure 12. Ground Pin Current vs. Input Voltage; one Channel on, I<sub>LOAD</sub> = 200mA

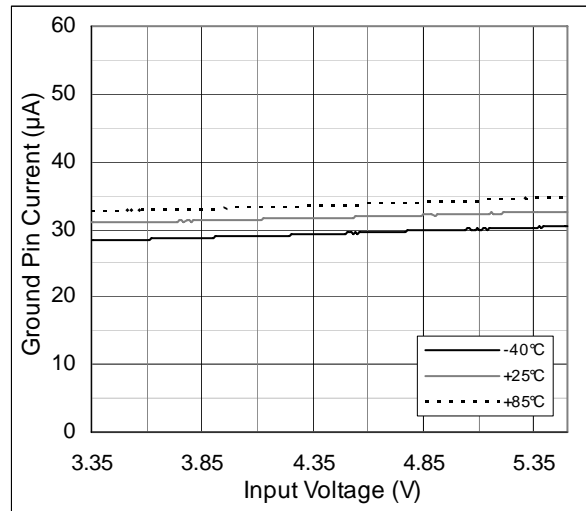

Figure 13. Ground Pin Current vs. Input Voltage; both Channels on, no Load

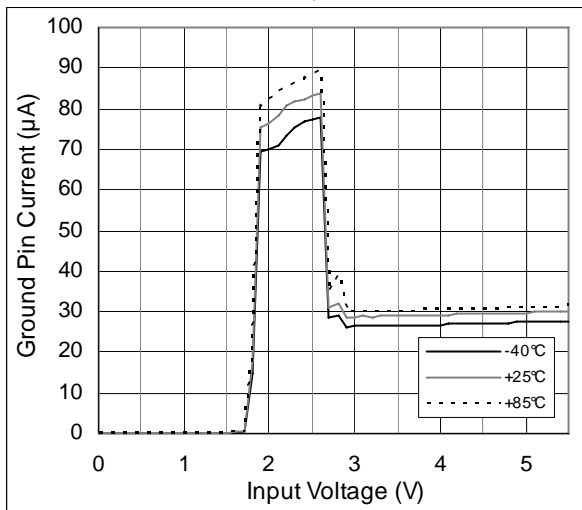

Figure 14. Ground Pin Current vs. Input Voltage; both Channels on, I<sub>LOAD</sub> = 200mA

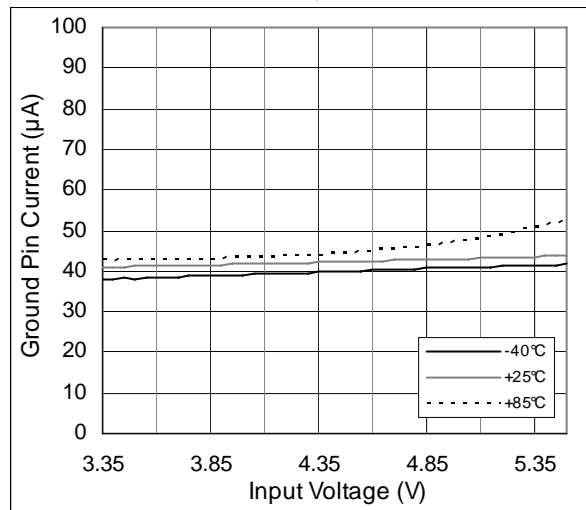

Figure 15. Shutdown Current vs. Input Voltage

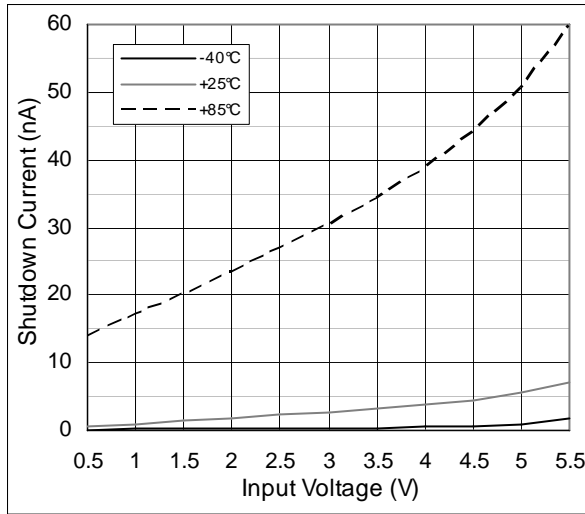

Figure 16. Load Regulation vs. Temperature

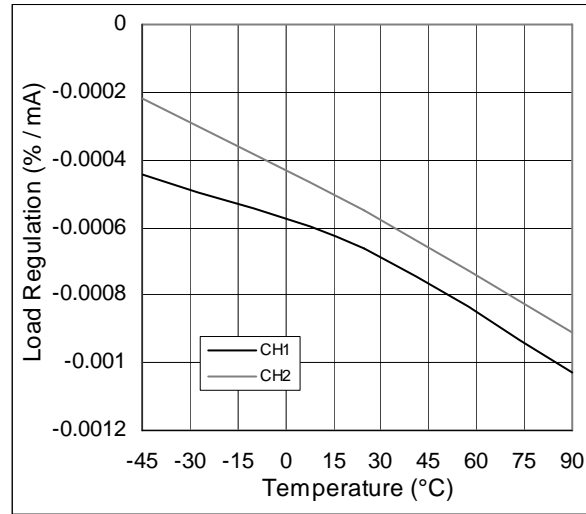

Figure 17. Line Regulation vs. Load Current

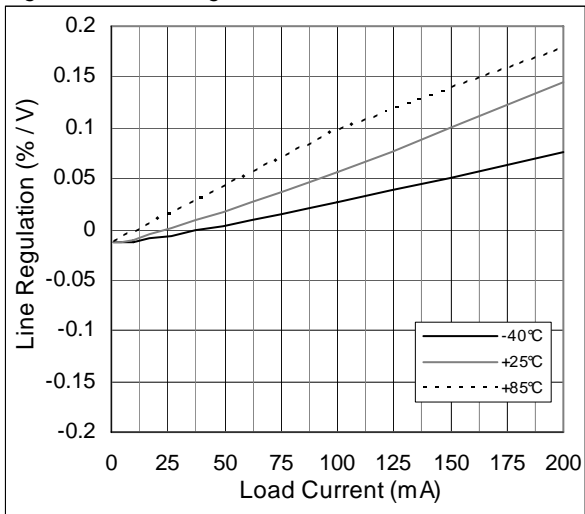

Figure 18. Line Regulation vs. Temperature

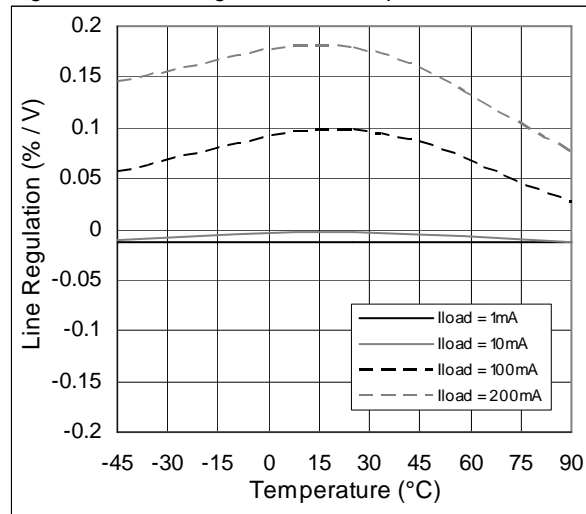

Figure 19. Load Transient Response, Crosstalk, between CH1 and CH2, I<sub>OUT</sub> = 200mA

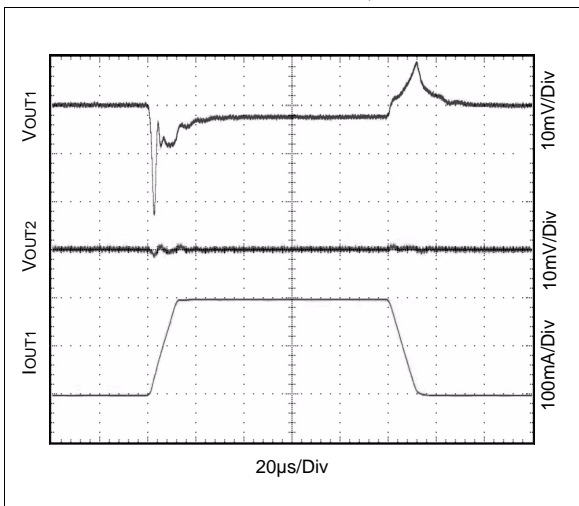

Figure 20. Load Transient Response near Dropout, I<sub>OUT</sub> = 200mA

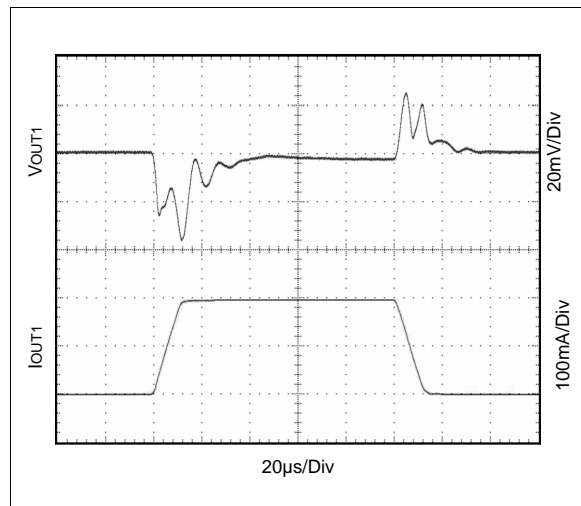

Figure 21. Line Transient Response

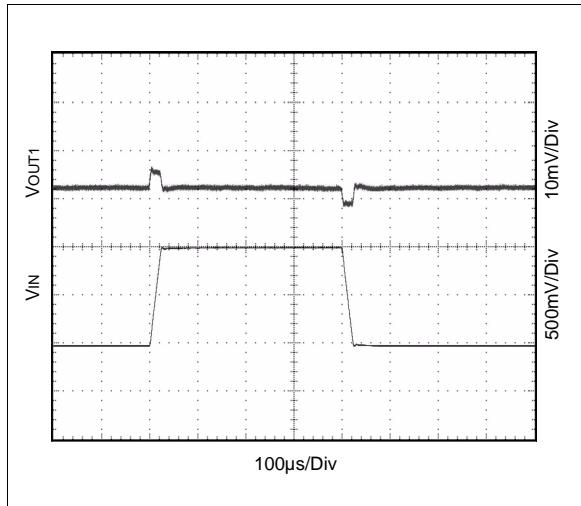

Figure 22. Shutdown

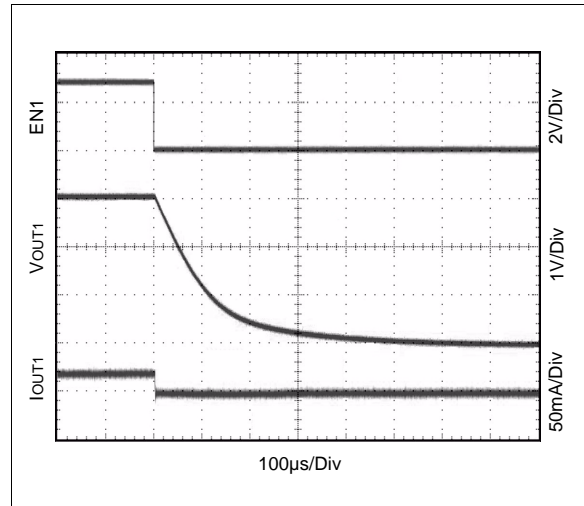

Figure 23. Startup of CH1 when CH2 is Off

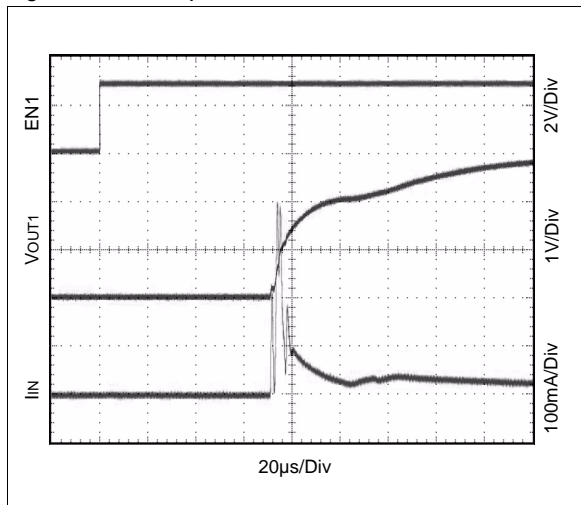
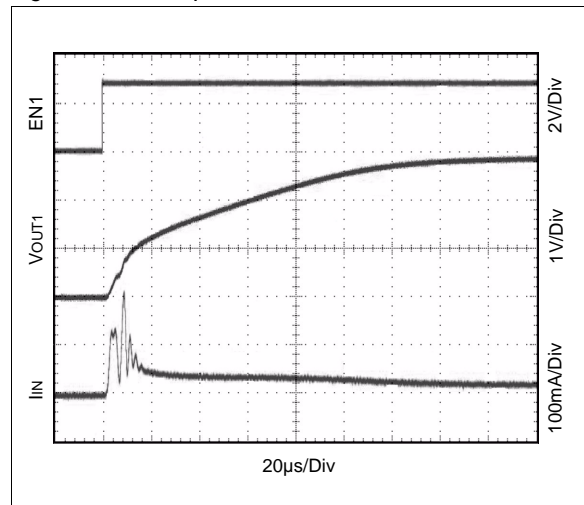

Figure 24. Startup of CH1 when CH2 is On





## 8 Detailed Description

The AS1374 is an ultra-low-noise, low-dropout, low-quiescent current linear-regulator with two separated outputs specifically designed for space-limited applications. These device can supply loads up to 200mA. As shown in [Figure 25](#), the AS1374 consist of an integrated bandgap core, error amplifier, P-channel MOSFET pass transistor, and internal feedback voltage-divider.

The output voltage is fed back through an internal resistor voltage-divider connected to pin OUT. Additional blocks include a current limiter, thermal sensor, and enable logic.

### Internal Voltage Reference

The bandgap reference is connected to the error amplifier's inverting input. The error amplifier compares this reference with the feedback voltage and amplifies the difference. If the feedback voltage is lower than the reference voltage, the pass-transistor gate is pulled low. This allows more current to pass to the output and increases the output voltage. If the feedback voltage is too high, the pass transistor gate is pulled high, allowing less current to pass to the output.

### Internal P-Channel Pass Transistor

The AS1374 feature a  $0.6\Omega$  (typ) P-channel MOSFET pass transistor, which provides several advantages over similar designs using a PNP pass transistor, including prolonged battery life. The P-channel MOSFET does not require a base driver, thus quiescent current is dramatically reduced. The AS1374 do not exhibit problems associated with typical PNP-based LDOs, and consume only  $30\mu\text{A}$  of quiescent current in light load and  $50\mu\text{A}$  in dropout (see [Typical Operating Characteristics](#) on page 5).

### Output Voltage

The AS1374 deliver preset output voltages from 1.2V to 3.6V, in 50mV increments (see [Ordering Information](#) on page 13).

### Enable

The AS1374 feature an active high enable mode to shutdown each output independent. Driving EN 1 low disables Output 1, driving EN 2 low disables Output 2. The disabled Output enters a high-impedance state.

Figure 25. AS1374 - Block Diagram

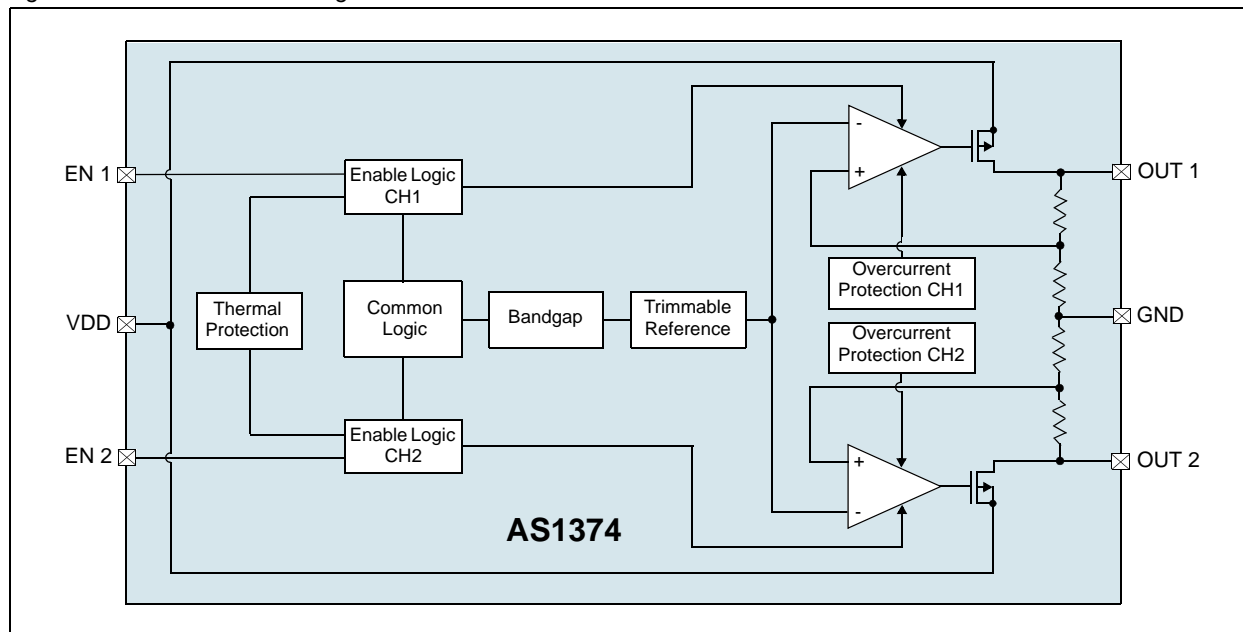

## Current Limit

The AS1374 include a current limiting circuitry to monitor and control the P-channel MOSFET pass transistor's gate voltage, thus limiting the device output current to 300mA.

**Note:** See [Table 3 on page 4](#) for the recommended min and max current limits. The output can be shorted to ground indefinitely without causing damage to the device.

## Thermal Protection

Integrated thermal protection circuitry limits total power dissipation in the AS1374. When the junction temperature ( $T_J$ ) exceeds  $+160^{\circ}\text{C}$ , the thermal sensor signals the shutdown logic, turning off the P-channel MOSFET pass transistor and allowing the device to cool down. The thermal sensor turns the pass transistor on again after the device's junction temperature drops by  $15^{\circ}\text{C}$ , resulting in a pulsed output during continuous thermal-overload conditions.

**Note:** Thermal protection is designed to protect the devices in the event of fault conditions. For continuous operation, do not exceed the absolute maximum junction temperature rating of  $+150^{\circ}\text{C}$ .

## Operating Region and Power Dissipation

The AS1374 maximum power dissipation is dependant on the thermal resistance of the case and PCB, the temperature difference between the die junction and  $T_{\text{AMB}}$ , and airflow rate.

Power dissipation across the device is calculated as:

$$PD = I_{\text{OUT}} (V_{\text{IN}} - V_{\text{OUT}}) \quad (\text{EQ 1})$$

The maximum power dissipation is calculated:

$$PD_{\text{MAX}} = (T_J - T_{\text{AMB}}) / \theta_{\text{JA}} \quad (\text{EQ 2})$$

### Where:

$T_J - T_{\text{AMB}}$  is the temperature difference between the AS1374 die junction and the surrounding air;

$\theta_{\text{JA}}$  is the thermal resistance through the circuit board, copper traces, and other materials to the surrounding.

## 9 Application Information

### Capacitor Selection and Regulator Stability

For normal operation, use a 1 $\mu$ F capacitor at pin VDD and a 1 $\mu$ F capacitor at pin OUT. Larger input capacitor values and lower ESR provide better noise rejection and line-transient response. Reduce output noise and improve load-transient response, stability, and power-supply rejection by using large output capacitors.

**Note:** Some ceramic dielectrics exhibit large capacitance and ESR variation with temperature. With dielectrics such as Z5U and Y5V, it may be necessary to use a 2.2 $\mu$ F or larger output capacitor to ensure stability at temperatures below -10°C. With X7R or X5R dielectrics, 1 $\mu$ F is sufficient at all operating temperatures.

### Noise, PSRR, and Transient Response

The AS1374 is designed to deliver ultra-low noise and high PSRR, as well as low dropout and low quiescent currents in battery-powered systems. The power-supply rejection is 85dB at 1kHz and 50dB at 100kHz. (see [Figure 8 on page 5](#)).

When operating from sources other than batteries, improved supply-noise rejection and transient response can be achieved by increasing the values of the input and output capacitors, and through passive filtering techniques.

The [Figure 19](#), [Figure 20 on page 7](#) and [Figure 21 on page 8](#) show the AS1374 Load- and Line- Transient Responses.

### Dropout Voltage

The AS1374 minimum dropout voltage determines the lowest usable supply voltage. In battery-powered systems, this determines the useful end-of-life battery voltage.

Since the AS1374 use a P-channel MOSFET pass transistor, the dropout voltage is a function of drain-to-source on-resistance ( $R_{DS(ON)}$ ) multiplied by  $I_{LOAD}$  (see [Figure 7 on page 5](#)).

## 10 Package Drawings and Markings

The devices are available in a 6-bump WLP package.

Figure 26. 6-bump WLP Package

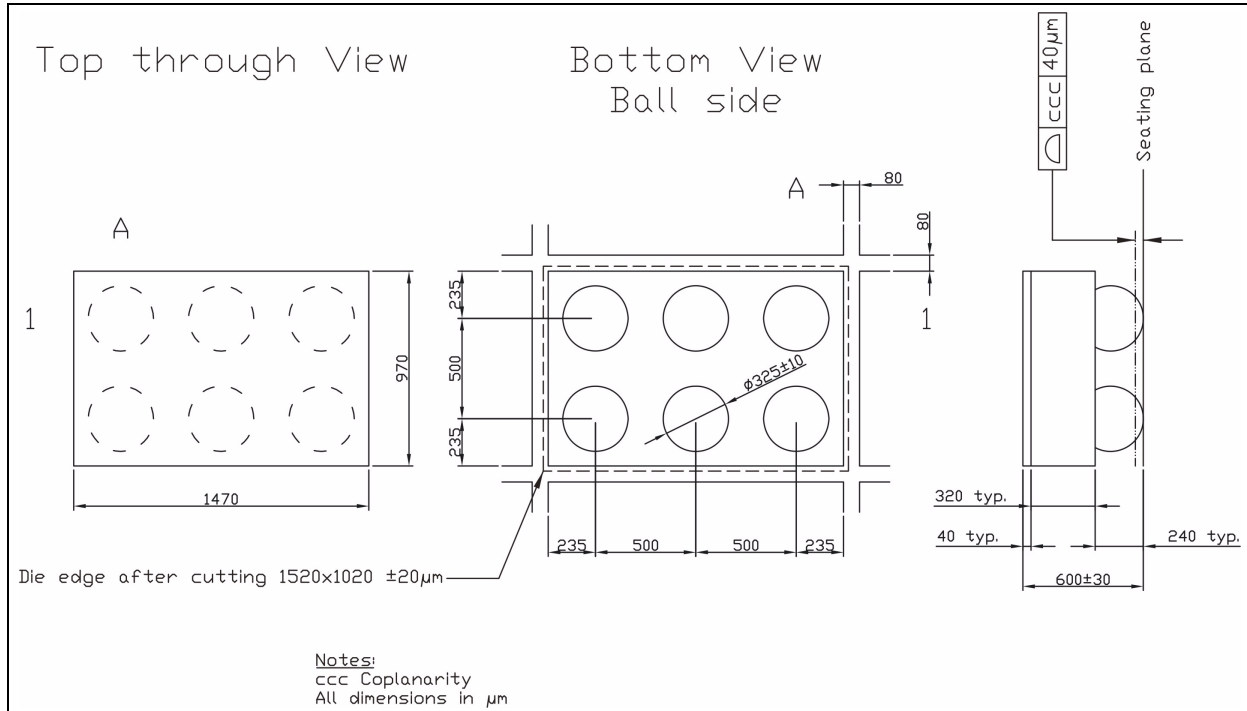

## 11 Ordering Information

The devices are available as the standard products shown in [Table 4](#).

Table 4. Ordering Information

Ordering Code	Marking	Output Voltage 1	Output Voltage 2	Delivery Form	Package
AS1374-BWLT-285	ASSH	2.85V	2.85V	Tape and Reel	6-bump WLP
AS1374-BWLT1833	ASSJ	1.8V	3.3V	Tape and Reel	6-bump WLP
AS1374-BWLT1218	ASSK	1.2V	1.8V	Tape and Reel	6-bump WLP

Non-standard devices from 1.2V to 3.6V are available in 50mV steps. For more information and inquiries contact <http://www.austriamicrosystems.com/contact>

**Note:** All products are RoHS compliant and Pb-free.

Buy our products or get free samples online at ICdirect: <http://www.austriamicrosystems.com/ICdirect>

For further information and requests, please contact us <mailto:sales@austriamicrosystems.com>  
or find your local distributor at <http://www.austriamicrosystems.com/distributor>

## Copyrights

Copyright © 1997-2009, austriamicrosystems AG, Tobelbaderstrasse 30, 8141 Unterpremstaetten, Austria-Europe. Trademarks Registered ®. All rights reserved. The material herein may not be reproduced, adapted, merged, translated, stored, or used without the prior written consent of the copyright owner.

All products and companies mentioned are trademarks or registered trademarks of their respective companies.

## Disclaimer

Devices sold by austriamicrosystems AG are covered by the warranty and patent indemnification provisions appearing in its Term of Sale. austriamicrosystems AG makes no warranty, express, statutory, implied, or by description regarding the information set forth herein or regarding the freedom of the described devices from patent infringement. austriamicrosystems AG reserves the right to change specifications and prices at any time and without notice. Therefore, prior to designing this product into a system, it is necessary to check with austriamicrosystems AG for current information. This product is intended for use in normal commercial applications. Applications requiring extended temperature range, unusual environmental requirements, or high reliability applications, such as military, medical life-support or life-sustaining equipment are specifically not recommended without additional processing by austriamicrosystems AG for each application. For shipments of less than 100 parts the manufacturing flow might show deviations from the standard production flow, such as test flow or test location.

The information furnished here by austriamicrosystems AG is believed to be correct and accurate. However, austriamicrosystems AG shall not be liable to recipient or any third party for any damages, including but not limited to personal injury, property damage, loss of profits, loss of use, interruption of business or indirect, special, incidental or consequential damages, of any kind, in connection with or arising out of the furnishing, performance or use of the technical data herein. No obligation or liability to recipient or any third party shall arise or flow out of austriamicrosystems AG rendering of technical or other services.



## Contact Information

### Headquarters

austriamicrosystems AG  
Tobelbaderstrasse 30  
A-8141 Unterpremstaetten, Austria

Tel: +43 (0) 3136 500 0  
Fax: +43 (0) 3136 525 01

For Sales Offices, Distributors and Representatives, please visit:

<http://www.austriamicrosystems.com/contact>