

## General Description

The AAT4610B SmartSwitch is a current limited P-channel MOSFET power switch designed for high-side load switching applications. This switch operates with inputs ranging from 2.4V to 5.5V, making it ideal for both 3V and 5V systems. An integrated current-limiting circuit protects the input supply against large currents which may cause the supply to fall out of regulation. The AAT4610B is also protected from thermal overload which limits power dissipation and junction temperatures. It can be used to control loads that require up to 1A. Current limit threshold is programmed with a resistor from SET to ground. The quiescent supply current is typically a low 9 $\mu$ A. In shutdown mode, the supply current decreases to less than 1 $\mu$ A.

The AAT4610B is available in a Pb-free 5-pin SOT23 or 8-pin SC70JW package and is specified over the -40°C to +85°C temperature range.

## Features

- Input Voltage Range: 2.4V to 5.5V
- Programmable Over-Current Threshold
- Fast Transient Response:
  - 400ns Response to Short Circuit
- Low Quiescent Current
  - 9 $\mu$ A Typical
  - 1 $\mu$ A Max with Switch Off
- 145m $\Omega$  Typical  $R_{DS(ON)}$
- Only 2.5V Needed for ON/OFF Control
- Under-Voltage Lockout
- Thermal Shutdown
- 4kV ESD Rating
- UL Approved—File No. E217765
- 5-Pin SOT23 or 8-Pin SC70JW Package
- Temperature Range: -40°C to +85°C

## Applications

- Hot Swap Supplies
- Notebook Computers
- Peripheral Ports
- Personal Communication Devices



**UL Recognized Component**

## Typical Application

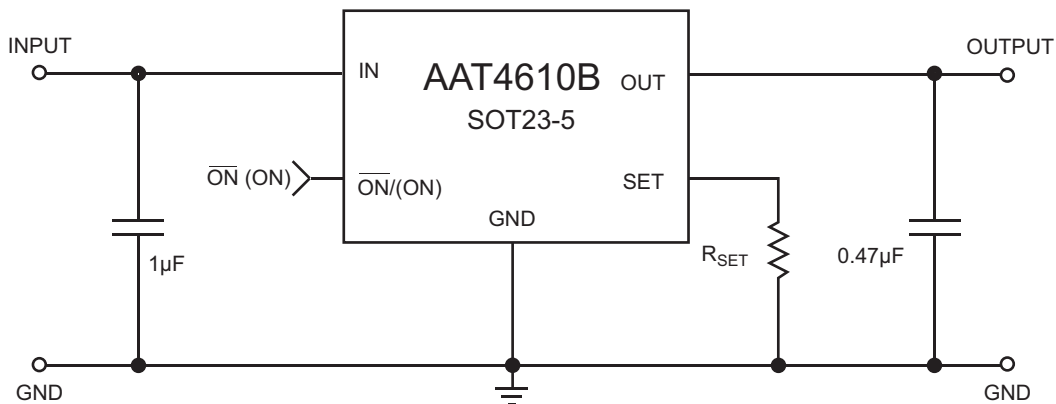

## Pin Descriptions

Pin Number		Symbol	Function
SOT23-5	SC70JW-8		
1	5	OUT	P-channel MOSFET drain. Connect a 0.47μF capacitor from OUT to GND.
2	6, 7, 8	GND	Ground connection.
3	1	SET	Current limit set input. A resistor from SET to ground sets the current limit for the switch.
4	2	$\overline{\text{ON}}$	Enable input. Two versions are available, active-high and active-low. See Ordering Information for details.
5	3, 4	IN	P-channel MOSFET source. Connect a 1μF capacitor from IN to GND.

## Pin Configuration

**SOT23-5  
(Top View)**

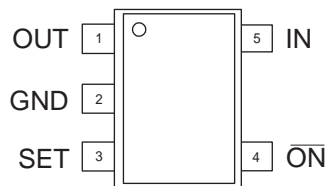

**SC70JW-8  
(Top View)**

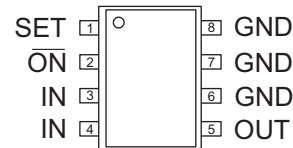

## Absolute Maximum Ratings<sup>1</sup>

$T_A = 25^\circ\text{C}$ , unless otherwise noted.

Symbol	Description	Value	Units
$V_{IN}$	IN to GND	-0.3 to 6	V
$V_{ON}$	$\overline{ON}$ (ON) to GND	-0.3 to $V_{IN} + 0.3$	V
$V_{SET}, V_{OUT}$	SET, OUT to GND	-0.3 to $V_{IN} + 0.3$	V
$I_{MAX}$	Maximum Continuous Switch Current	2	A
$T_J$	Operating Junction Temperature Range	-40 to 150	$^\circ\text{C}$
$T_{LEAD}$	Maximum Soldering Temperature (at Leads)	300	$^\circ\text{C}$
$V_{ESD}$	ESD Rating <sup>2</sup> - HBM	4000	V

## Thermal Characteristics<sup>3</sup>

Symbol	Description	Value	Units
$\Theta_{JA}$	Thermal Resistance (SOT23-5 or SC70JW-8)	150	$^\circ\text{C}/\text{W}$
$P_D$	Power Dissipation (SOT23-5 or SC70JW-8)	667	mW

1. Stresses above those listed in Absolute Maximum Ratings may cause permanent damage to the device. Functional operation at conditions other than the operating conditions specified is not implied. Only one Absolute Maximum Rating should be applied at any one time.

2. Human body model is a 100pF capacitor discharged through a 1.5k $\Omega$  resistor into each pin.

3. Mounted on a demo board.

## Electrical Characteristics

$V_{IN} = 5V$ ,  $T_A = -40^{\circ}C$  to  $+85^{\circ}C$ , unless otherwise noted. Typical values are  $T_A = 25^{\circ}C$ .

Symbol	Description	Conditions	Min	Typ	Max	Units
$V_{IN}$	Operation Voltage		2.4		5.5	V
$I_Q$	Quiescent Current	$V_{IN} = 5V$ , ON ( $\overline{ON}$ ) = Active, $I_{OUT} = 0$		9	25	$\mu A$
$I_{Q(OFF)}$	Off Supply Current	ON ( $\overline{ON}$ ) = Inactive, $V_{IN} = 5.5V$			1	$\mu A$
$I_{SD(OFF)}$	Off Switch Current	ON ( $\overline{ON}$ ) = Inactive, $V_{IN} = 5.5V$ , $V_{OUT} = 0$		0.01	1	$\mu A$
$V_{UVLO}$	Under-Voltage Lockout	Rising Edge, 1% Hysteresis		1.8	2.4	V
$R_{DS(ON)}$	On Resistance	$V_{IN} = 5.0V$ , $T_A = 25^{\circ}C$		145	180	m $\Omega$
		$V_{IN} = 4.5V$ , $T_A = 25^{\circ}C$		150		
		$V_{IN} = 3.0V$ , $T_A = 25^{\circ}C$		190	230	
$TC_{RDS}$	On Resistance Temperature Coefficient			2800		ppm/ $^{\circ}C$
$I_{LIM}$	Current Limit	$R_{SET} = 6.8k\Omega$	1.2	1.6	2.0	A
$I_{LIM(MIN)}$	Minimum Current Limit			130		mA
$V_{ON(L)}$	ON ( $\overline{ON}$ ) Input Low Voltage	$V_{IN} = 2.7V$ to $5.5V^1$			0.8	V
$V_{ON(H)}$	ON ( $\overline{ON}$ ) Input High Voltage	$V_{IN} = 2.7V$ to $< 4.2V^1$	2.0			V
		$V_{IN} \geq 4.2V$ to $5.0V^1$	2.4			
$I_{ON(SINK)}$	ON ( $\overline{ON}$ ) Input Leakage	$V_{ON} = 5.5V$		0.01	1	$\mu A$
$T_{RESP}$	Current Limit Response Time	$V_{IN} = 5V$		0.4		$\mu s$
$T_{OFF}$	Turn-Off Time	$V_{IN} = 5V$ , $R_L = 10\Omega$		4	12	$\mu s$
$T_{ON}$	Turn-On Time	$V_{IN} = 5V$ , $R_L = 10\Omega$		12	200	$\mu s$
$T_{SD}$	Over-Temperature Threshold	$V_{IN} = 5V$	$T_J$ Increasing	125		$^{\circ}C$
			$T_J$ Decreasing	115		

1. For  $V_{IN}$  outside this range, consult Typical ON ( $\overline{ON}$ ) Threshold curve.

## Typical Characteristics

Unless otherwise noted,  $V_{IN} = 5V$ ,  $T_A = 25^\circ C$ .

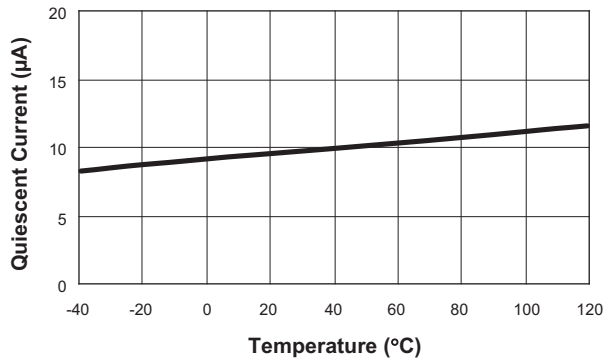
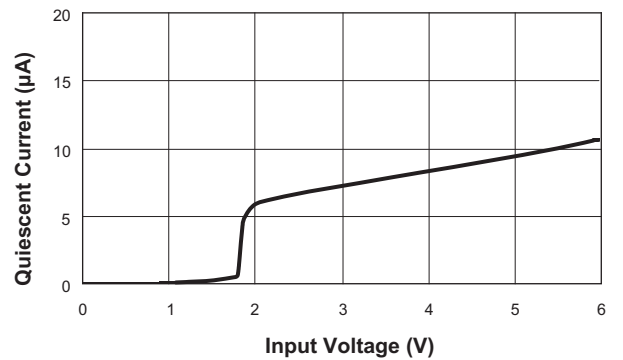
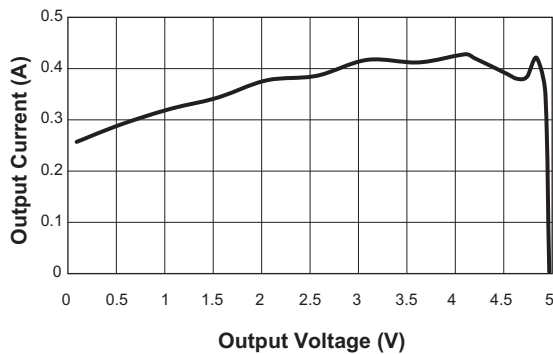
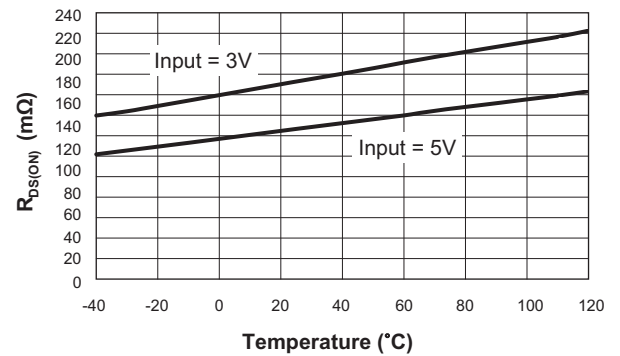
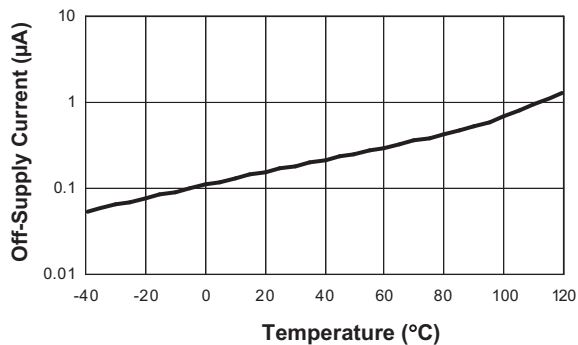
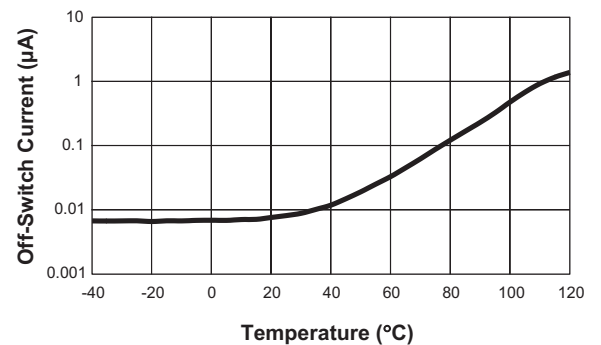
**Quiescent Current vs. Temperature**

**Quiescent Current vs. Input Voltage**

**Output Current vs. Output Voltage**  
 ( $R_{SET} = 22.1k\Omega$ )

 **$R_{DS(ON)}$  vs. Temperature**

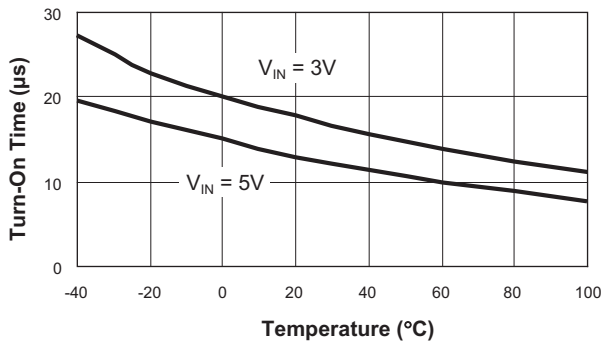
**Off-Supply Current vs. Temperature**

**Off-Switch Current vs. Temperature**

**Typical Characteristics**

Unless otherwise noted,  $V_{IN} = 5V$ ,  $T_A = 25^\circ C$ .

**Turn-On vs. Temperature**  
( $R_{LOAD} = 10\Omega$ ;  $C_{LOAD} = 0.47\mu F$ )



**Turn-Off vs. Temperature**  
( $R_{LOAD} = 10\Omega$ ;  $C_{LOAD} = 0.47\mu F$ )

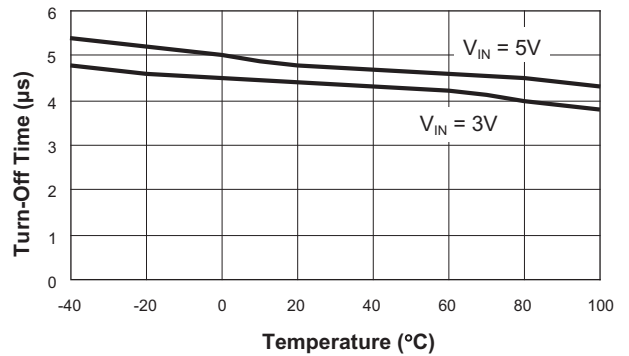

**Turn-On**  
( $R_L = 10\Omega$ ;  $C_L = 0.47\mu F$ )

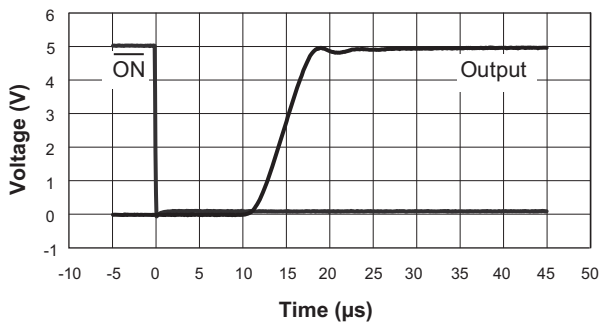

**Turn-Off**  
( $R_L = 10\Omega$ ;  $C_L = 0.47\mu F$ )

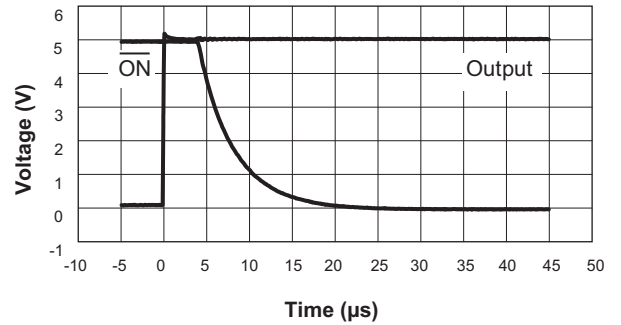

**Short-Circuit Through 0.3Ω**

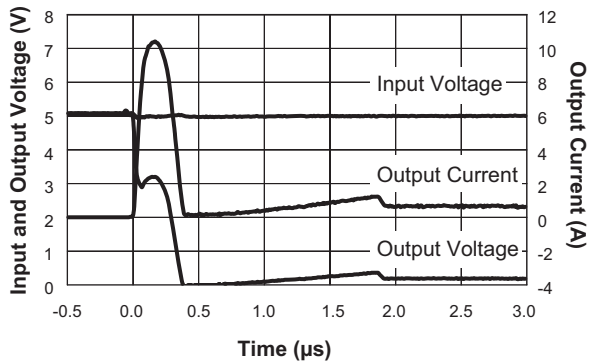

**$V_{IH}$  and  $V_{IL}$  vs.  $V_{IN}$**

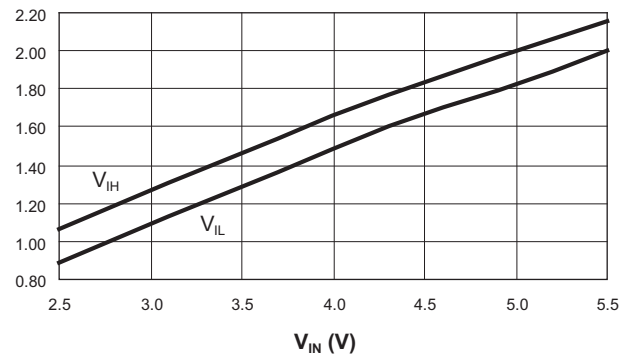

## Typical Characteristics

Unless otherwise noted,  $V_{IN} = 5V$ ,  $T_A = 25^\circ C$ .

**$R_{SET}$  vs.  $I_{LIM}$**

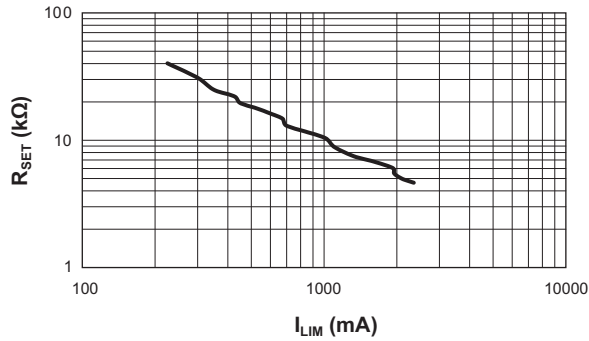

**$R_{SET}$  Coefficient vs.  $I_{LIM}$**

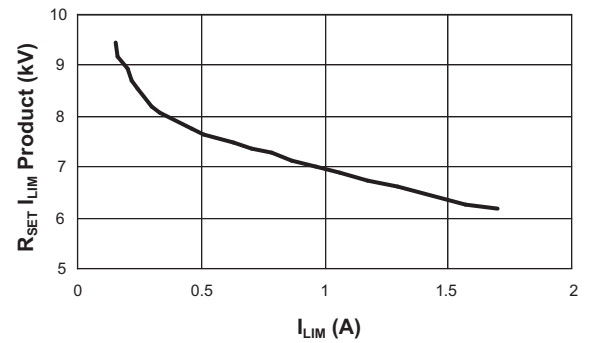

**Output Current vs. Temperature**  
( $R_{SET} = 22.1k\Omega$ )

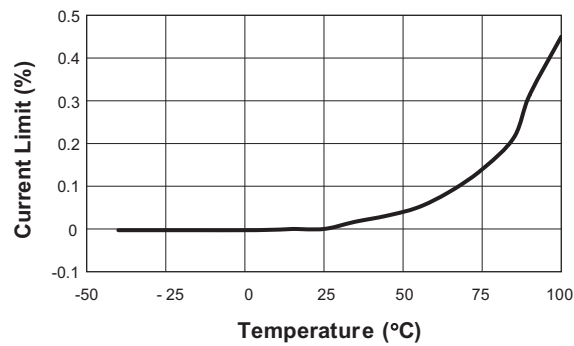

## Functional Block Diagram

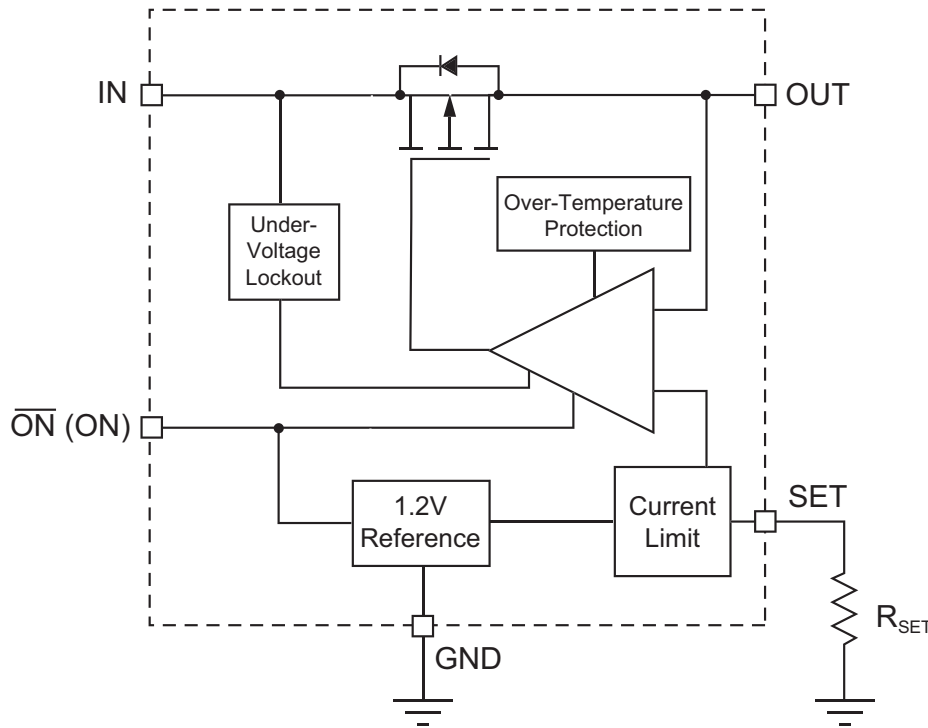

## Application Information

### Setting Current Limit

In most applications, the variation in  $I_{LIM}$  must be taken into account when determining  $R_{SET}$ . The  $I_{LIM}$  variation is due to processing variations from part to part, as well as variations in the voltages at IN and OUT, plus the operating temperature. See charts "Current Limit vs. Temperature" and "Output Current vs.  $V_{OUT}$ ." Together, these three factors add up to a  $\pm 25\%$  tolerance (see  $I_{LIM}$  specification in Electrical Characteristics section). Figure 1 illustrates a cold device with a statistically higher current limit and a hot device with a statistically lower current limit, both with  $R_{SET}$  equal to  $8.87k\Omega$ . While the chart, " $R_{SET}$  vs.  $I_{LIM}$ " indicates an  $I_{LIM}$  of  $1.1A$  with an  $R_{SET}$  of  $10.5k\Omega$ , this figure shows that the actual current limit will be at least  $0.825A$  and no greater than  $1.375A$ .

To determine  $R_{SET}$ , start with the maximum current drawn by the load and multiply it by  $1.33$  (typical  $I_{LIM} = \text{minimum } I_{LIM} / 0.75$ ). This is the typical current limit value. Next, refer to " $R_{SET}$  vs.  $I_{LIM}$ " and find the  $R_{SET}$  that corresponds to the typical current limit value. Choose the

largest resistor available that is less than or equal to it. For greater precision, the value of  $R_{SET}$  may also be calculated using the  $I_{LIM} R_{SET}$  product found in the chart " $R_{SET}$  Coefficient vs.  $I_{LIM}$ ." The maximum current is derived by multiplying the typical current for the chosen  $R_{SET}$  in the chart by  $1.25$ . A few standard resistor values are listed in Table 1.

**Current Limit vs. Output Voltage**  
( $R_{SET} = 8.87k\Omega$ )

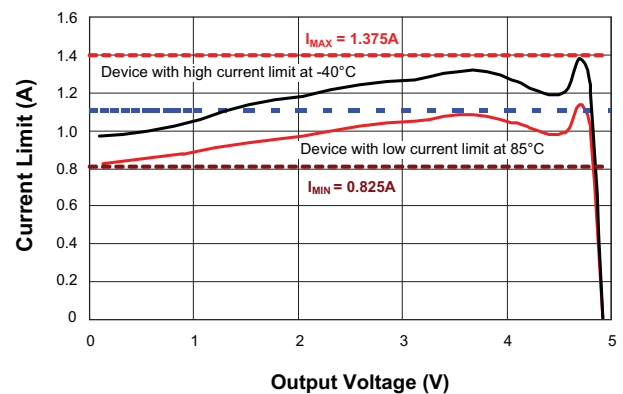

**Figure 1: Current Limit Using  $10.5k\Omega$ .**



$R_{SET}$ (k $\Omega$ )	Current Limit Typ (mA)	Device Will Not Current Limit Below (mA)	Device Always Current Limits Below (mA)
40.2	225	169	281
30.9	300	225	375
24.9	350	263	438
22.1	425	319	531
19.6	450	338	563
17.8	525	394	656
16.2	600	450	750
14.7	675	506	844
13	700	525	875
10.5	1000	750	1250
8.87	1100	825	1375
7.5	1325	994	1656
6.81	1600	1200	2000
6.04	1925	1444	2406
5.49	1950	1463	2438
4.99	2100	1575	2625
4.64	2350	1763	2938

**Table 1: Current Limit  $R_{SET}$  Values**

Example: A USB port requires 0.5A. 0.5A multiplied by 1.33 is 0.665A. From the chart named " $R_{SET}$  vs.  $I_{LIM}$ ,"  $R_{SET}$  should be less than 18k $\Omega$ . 17.8k $\Omega$  is a standard value that is a little less than 18k $\Omega$  but very close. The chart reads approximately 0.525A as a typical  $I_{LIM}$  value for 17.8k $\Omega$ . Multiplying 0.525A by 0.75 and 1.25 shows that the AAT4610B will limit the load current to greater than 0.394A but less than 0.656A.

## Operation in Current Limit

When a heavy load is applied to the output of the AAT4610B, the load current is limited to the value of  $I_{LIM}$  determined by  $R_{SET}$  (see Figure 2). Since the load is demanding more current than  $I_{LIM}$ , the voltage at the output drops. This causes the AAT4610B to dissipate a larger than normal quantity of power, and its die temperature to increase. When the die temperature exceeds an over-temperature limit, the AAT4610B will shut down until it has cooled sufficiently, at which point it will startup again. The AAT4610B will continue to cycle on and off until the load is removed, power is removed, or until a logic high level is applied to ON.

## Enable Input

In many systems, power planes are controlled by integrated circuits which run at lower voltages than the power plane itself. The enable input ON of the AAT4610B has low and high threshold voltages that accommodate this condition. The threshold voltages are compatible with 5V TTL and 2.5V to 5V CMOS.

## Reverse Voltage

The AAT4610B is designed to control current flowing from IN to OUT. If a voltage is applied to OUT which is greater than the voltage on IN, large currents may flow. This could cause damage to the AAT4610B.

### Overload Operation

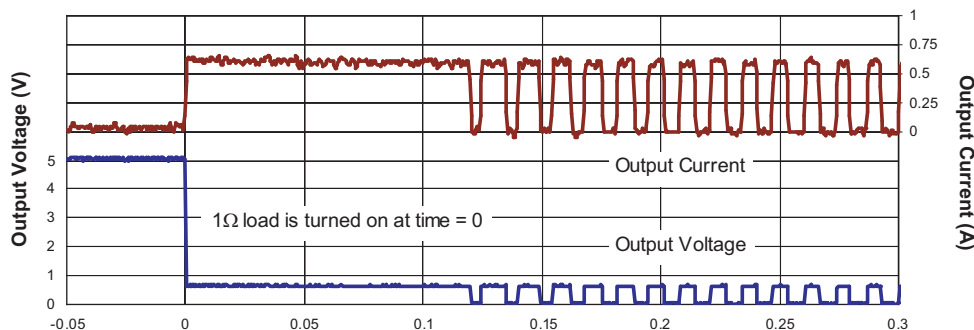
**Figure 2: Overload Operation.**

## Ordering Information

Package	Enable	Marking <sup>1</sup>	Part Number (Tape and Reel) <sup>2</sup>
SOT23-5	ON (active high)	8FXYY	<b>AAT4610BIGV-1-T1</b>
SC70JW-8	ON (active high)	8GXYY	<b>AAT4610BIJS-1-T1</b>
SOT23-5	ON (active low)	B9XYY	<b>AAT4610BIGV-T1</b>
SC70JW-8	ON (active low)	B8XYY	<b>AAT4610BIJS-T1</b>



All AnalogicTech products are offered in Pb-free packaging. The term “Pb-free” means semiconductor products that are in compliance with current RoHS standards, including the requirement that lead not exceed 0.1% by weight in homogeneous materials. For more information, please visit our website at <http://www.analogictech.com/aboutus/quality.php>.

## Package Information

### SOT23-5

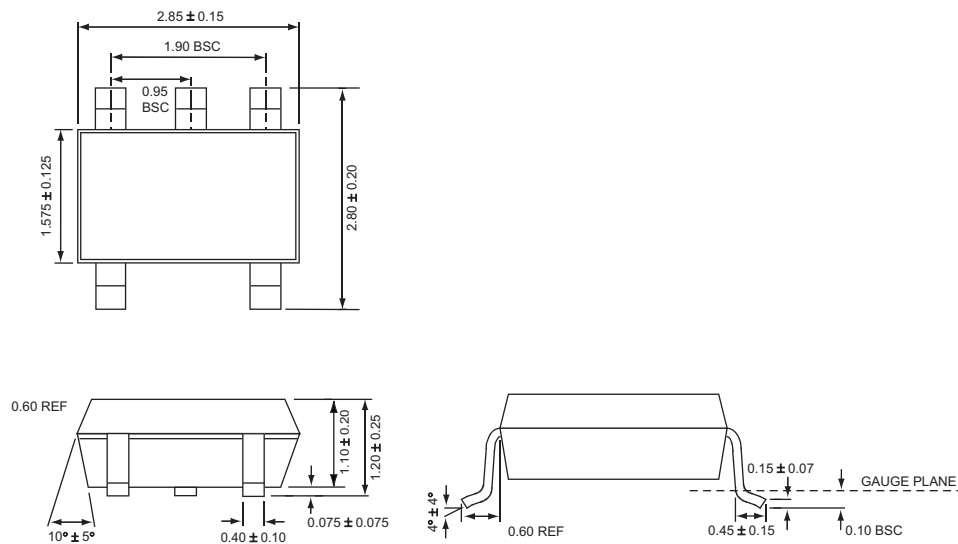

All dimensions in millimeters.

1. XYY = assembly and date code.  
2. Sample stock is generally held on part numbers listed in **BOLD**.

## SC70JW-8

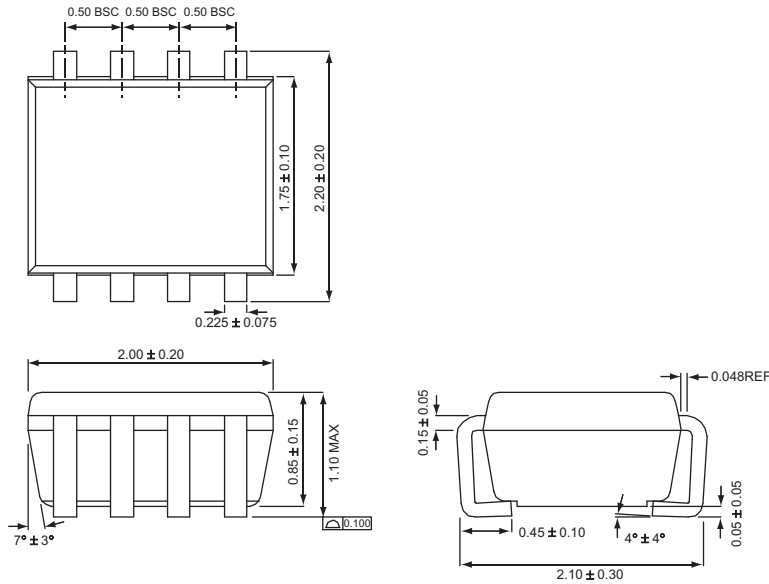

All dimensions in millimeters.

**Advanced Analogic Technologies, Inc.**  
 3230 Scott Boulevard, Santa Clara, CA 95054  
 Phone (408) 737-4600  
 Fax (408) 737-4611