

General Description

The AAT3223 PowerLinear NanoPower low dropout (LDO) linear regulator is ideal for portable applications where extended battery life is critical. This device features extremely low quiescent current, typically 1.1µA. Dropout voltage is also very low, typically 190mV at 100mA. The AAT3223 has an enable pin which, when pulled low, will put the LDO regulator into shutdown mode, removing power from its load and offering extended power conservation capabilities for portable battery-powered applications. The AAT3223 also has a Power-OK (POK) feature which monitors the LDO output voltage and will alert the system if the output falls out of regulation.

The AAT3223 has output short-circuit and over-current protection. In addition, the device has an over-temperature protection circuit, which will shut down the LDO regulator during extended over-current events.

The AAT3223 is available in a Pb-free, space-saving 6-pin SOT23 package and is rated over the -40°C to +85°C temperature range.

The AAT3223 is similar to the AAT3221 with the exception that it offers the additional Power-OK function through the POK pin.

Features

- 1.1µA Quiescent Current
- 250mA Output Current
- Low Dropout: 190mV (typical)
- High Accuracy: ±2%
- Current Limit Protection
- Over-Temperature Protection
- Extremely Low Power Shutdown Mode
- Low Temperature Coefficient
- Stable Operation With Virtually Any Output Capacitor Type
- Power-OK Signal Output
- Active High Enable Pin
- 4kV ESD
- Factory-Programmed Output Voltages
- 6-pin SOT23 Package

Applications

- Cellular Phones
- Digital Cameras
- Handheld Electronics
- Notebook Computers
- PDAs
- Portable Communication Devices
- Remote Controls

Typical Application

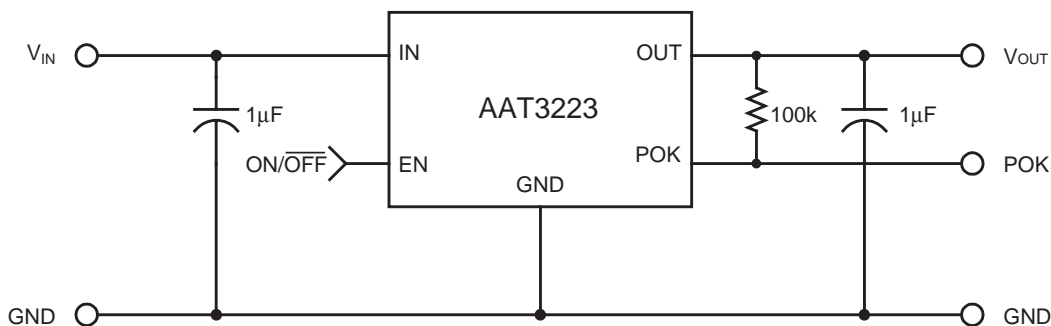

Pin Descriptions

Pin #	Symbol	Function
1	IN	Input pin. It is recommended to bypass this pin with a 1 μ F capacitor.
2	GND	Ground connection pin.
3	OUT	Output pin. This pin should be decoupled with a 1 μ F or larger capacitor.
4	N/C	Not connected.
5	EN	Enable input. Active high, logic level compatible.
6	POK	Power-OK output pin. This pin is pulled to ground during a power failure; it is normally high impedance and should have a 100k Ω pull-up resistor connected to OUT.

Pin Configuration

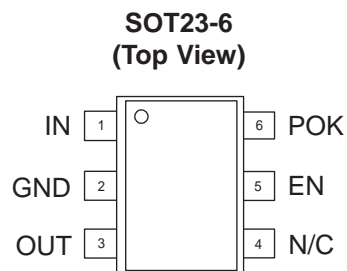

Absolute Maximum Ratings¹

$T_A = 25^\circ\text{C}$, unless otherwise noted.

Symbol	Description	Value	Units
V_{IN}	Input Voltage	-0.3 to 6	V
V_{EN}	EN to GND Voltage	-0.3 to 6	V
$V_{ENIN(MAX)}$	Maximum EN to Input Voltage	0.3	V
I_{OUT}	Maximum DC Output Current	$P_D/(V_{IN} - V_O)$	mA
T_J	Operating Junction Temperature Range	-40 to 150	$^\circ\text{C}$
T_{LEAD}	Maximum Soldering Temperature (at leads, 10 sec)	300	$^\circ\text{C}$

Thermal Information²

Symbol	Description	Rating	Units
Θ_{JA}	Thermal Resistance	150	$^\circ\text{C}/\text{W}$
P_D	Power Dissipation ³	667	mW

Recommended Operating Conditions

Symbol	Description	Rating	Units
V_{IN}	Input Voltage ⁴	$(V_{OUT} + V_{DO})$ to 5.5	V
T	Ambient Temperature Range	-40 to +85	$^\circ\text{C}$

1. Stresses above those listed in Absolute Maximum Ratings may cause permanent damage to the device. Functional operation at conditions other than the operating conditions specified is not implied. Only one Absolute Maximum Rating should be applied at any one time.

2. Mounted on a demo board.

3. Derate 6.7mW/ $^\circ\text{C}$ above 25 $^\circ\text{C}$.

4. To calculate minimum input voltage, use the following equation: $V_{IN(MIN)} = V_{OUT(MAX)} + V_{DO(MAX)}$ as long as $V_{IN} \geq 2.5\text{V}$.

Electrical Characteristics

$V_{IN} = V_{OUT(NOM)} + 1V$, $I_{OUT} = 1mA$, $C_{OUT} = 1\mu F$, $T_A = 25^\circ C$, unless otherwise noted.

Symbol	Description	Conditions	Min	Typ	Max	Units	
V_{OUT}	DC Output Voltage Tolerance		-2.0		2.0	%	
I_{OUT}	Output Current	$V_{OUT} > 1.2V$	250			mA	
I_{SC}	Short-Circuit Current	$V_{OUT} < 0.4V$		400		mA	
I_Q	Ground Current	$V_{IN} = 5V$, No Load		1.1	2.5	μA	
I_{Q-OFF}	Off-Supply Current	$V_{IN} = 5V$, EN = Inactive		0.01	1	μA	
$\Delta V_{OUT}/V_{OUT}$	Line Regulation	$V_{IN} = 4.0V$ to $5.5V$	0.15	0.4		%/V	
$\Delta V_{OUT}/V_{OUT}$	Load Regulation	$I_L = 1$ to $100mA$	$V_{OUT} = 1.8V$		1.0	1.65	%
			$V_{OUT} = 2.7V$		0.7	1.25	
			$V_{OUT} = 2.8V$		0.7	1.20	
			$V_{OUT} = 2.85V$		0.7	1.20	
			$V_{OUT} = 3.0V$		0.6	1.15	
			$V_{OUT} = 3.3V$		0.5	1.00	
V_{DO}	Dropout Voltage ^{1,2}	$I_{OUT} = 100mA$	$V_{OUT} = 2.7V$		200	240	mV
			$V_{OUT} = 2.8V$		190	235	
			$V_{OUT} = 2.85V$		190	230	
			$V_{OUT} = 3.0V$		190	225	
			$V_{OUT} = 3.3V$		180	220	
PSRR	Power Supply Rejection Ratio	100Hz		50		dB	
T_{SD}	Over-Temperature Shutdown Threshold			140		$^\circ C$	
T_{HYS}	Over-Temperature Shutdown Hysteresis			20		$^\circ C$	
e_N	Output Noise			350		μV_{RMS}	
T_C	Output Voltage Temperature Coefficient			80		PPM/ $^\circ C$	
POK							
POK_{TH}	POK Trip Threshold	Falling	25 $^\circ C$	87.5	90.5	93.5	% of V_{OUT}
			-40 $^\circ C$ to +85 $^\circ C$	86		95	
POK_{HYS}	POK Hysteresis			1.5			
I_{POK}	POK Off-Current	$V_{POK} = 5.5V$, $T_A = 25^\circ C$			100	nA	
V_{POK}	POK Low Voltage	$I_{POK} = 1mA$			200	mV	
T_{POK}	POK Delay	V_{OUT} Rising		1.5		ms	
EN							
V_{IH}	EN Input Threshold High	$V_{IN} = 2.5V$ to $5.5V$	2			V	
V_{IL}	EN Input Threshold Low	$V_{IN} = 2.5V$ to $5.5V$			0.5		
$I_{EN(SINK)}$	EN Input Leakage	$V_{ON} = 5.5V$		0.01	1	μA	

1. V_{DO} is defined as $V_{IN} - V_{OUT}$ when V_{OUT} is 98% of nominal.

2. For $V_{OUT} < 2.3V$, $V_{DO} = 2.5V - V_{OUT}$.

Typical Characteristics

Unless otherwise noted, $V_{IN} = V_{OUT} + 1V$, $T_A = 25^\circ C$, $C_{IN} = C_{OUT} = 1\mu F$ ceramic.

Output Voltage vs. Output Current

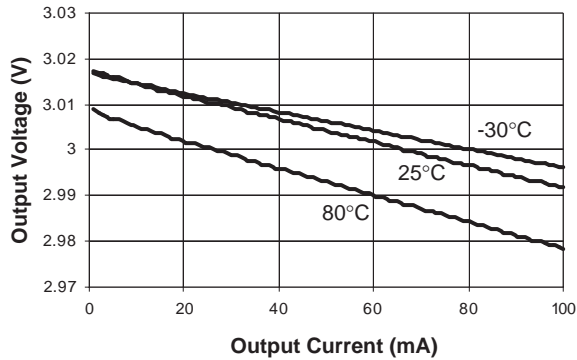

Output Voltage vs. Input Voltage

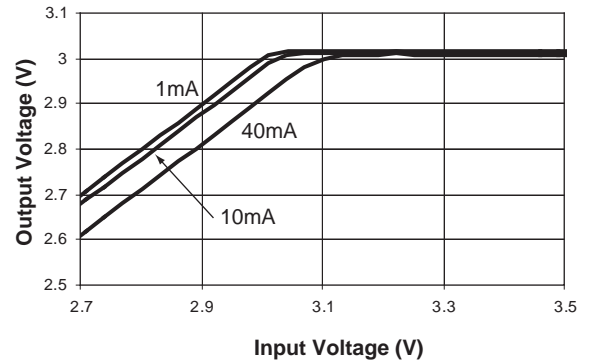

Output Voltage vs. Input Voltage

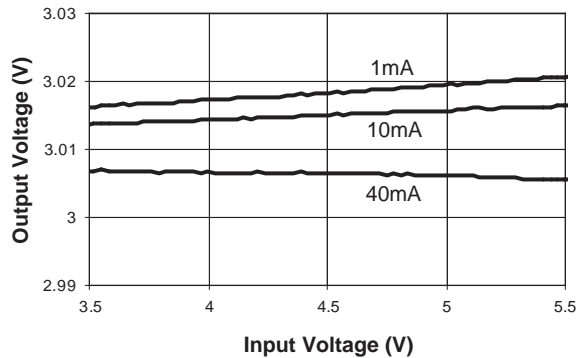

Dropout Voltage vs. Output Current

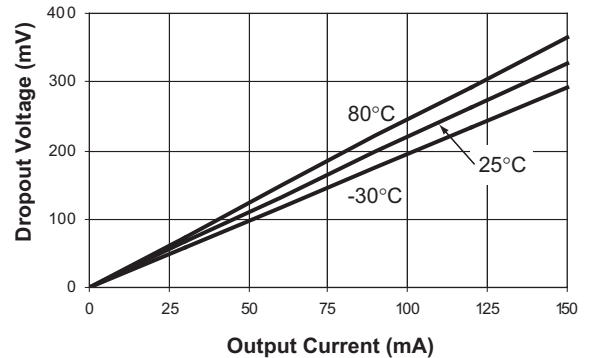

Input Current vs. Input Voltage

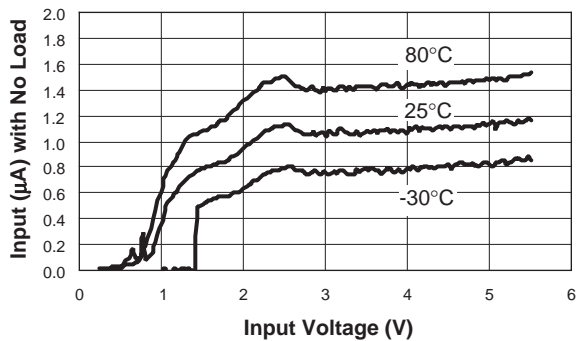

PSRR With 10mA Load

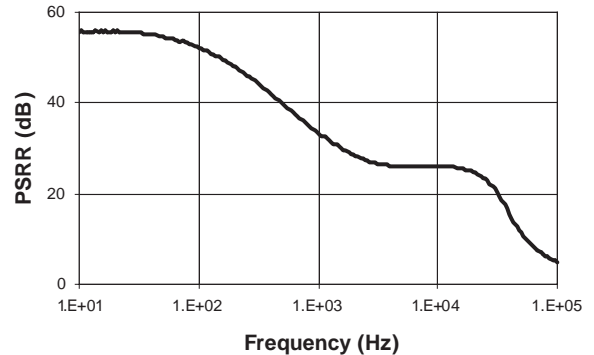

Typical Characteristics

Unless otherwise noted, $V_{IN} = V_{OUT} + 1V$, $T_A = 25^\circ C$, $C_{IN} = C_{OUT} = 1\mu F$ ceramic.

Noise Spectrum

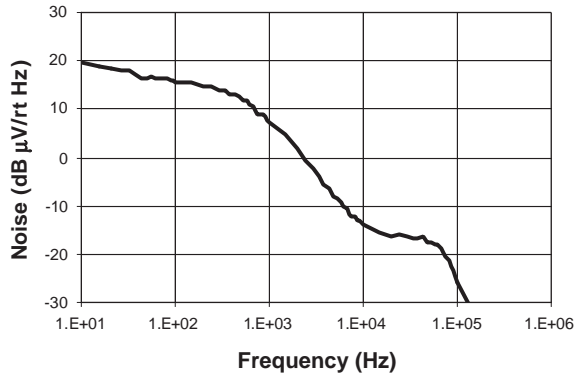

Line Response With 1mA Load

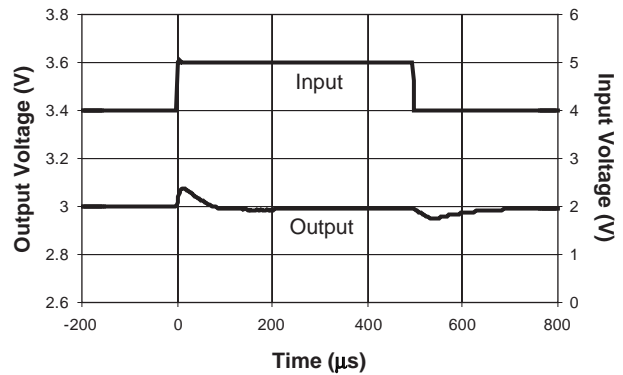

Line Response With 10mA Load

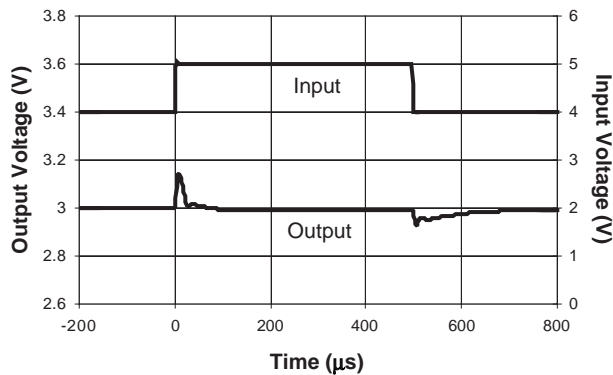

Line Response With 100mA Load

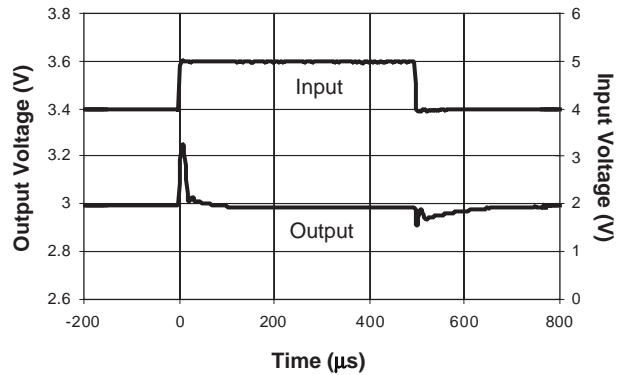

Load Transient - 1mA / 40mA

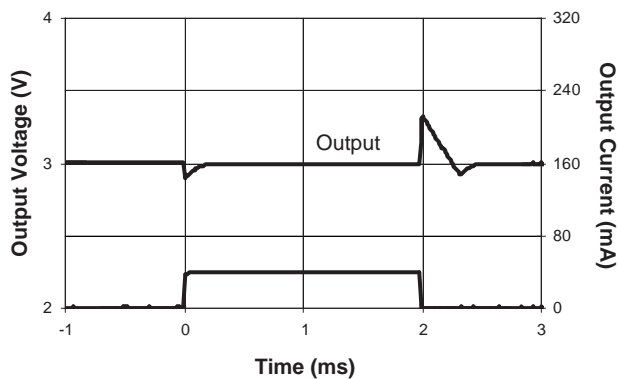

Load Transient - 1mA / 80mA

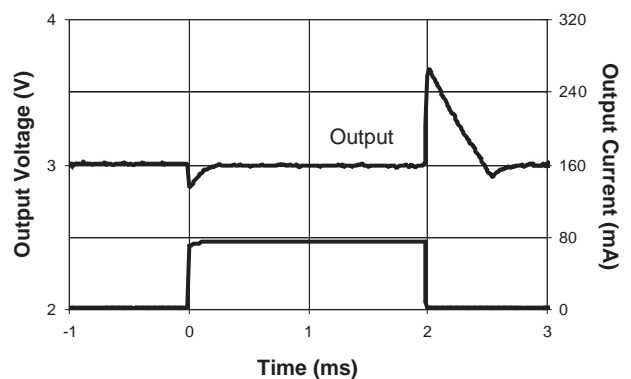

Typical Characteristics

Unless otherwise noted, $V_{IN} = V_{OUT} + 1V$, $T_A = 25^\circ C$, $C_{IN} = C_{OUT} = 1\mu F$ ceramic.

Power-Up With 1mA Load

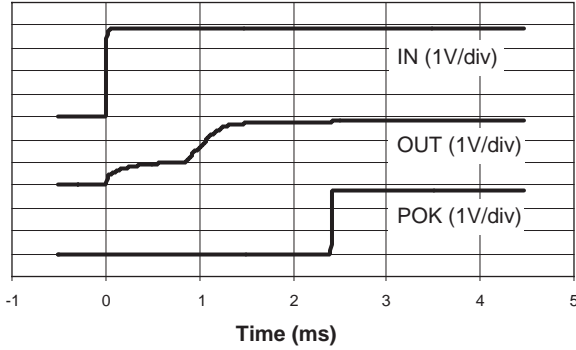

Turn-On With 1mA Load

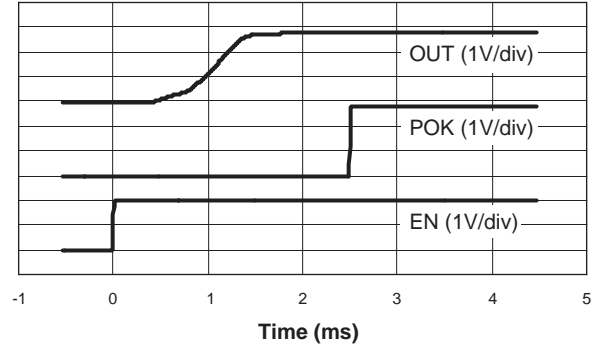

Power-Up With 10mA Load

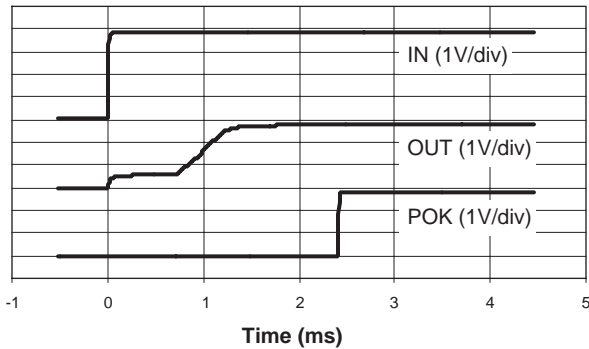

Turn-On With 10mA Load

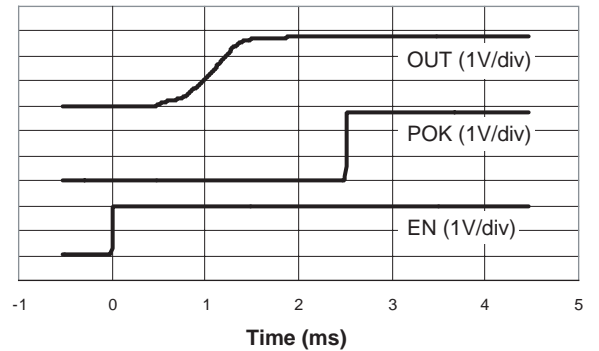

Power-Up With 100mA Load

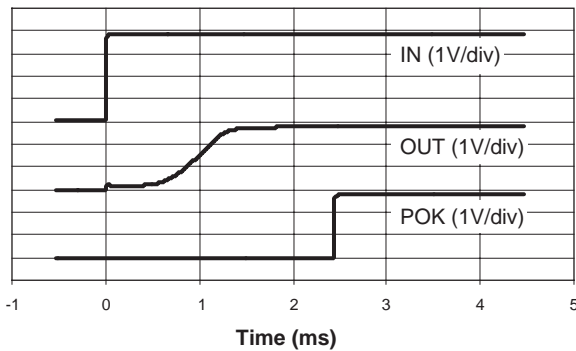

Turn-On With 100mA Load

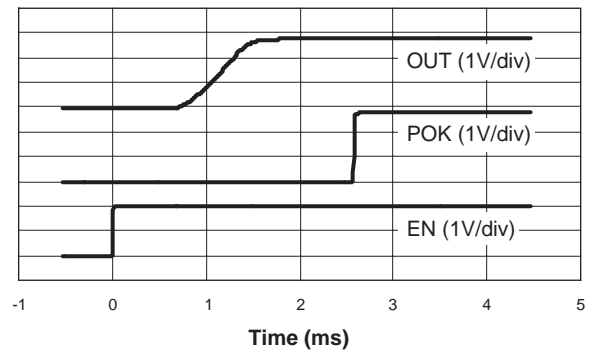

Typical Characteristics

Unless otherwise noted, $V_{IN} = V_{OUT} + 1V$, $T_A = 25^\circ C$, $C_{IN} = C_{OUT} = 1\mu F$ ceramic.

Power-Off from 100mA Load

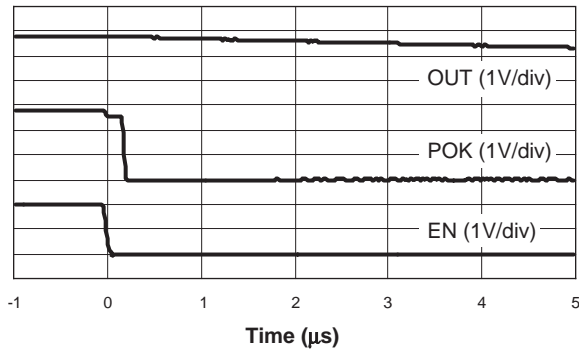

Current Limit Response

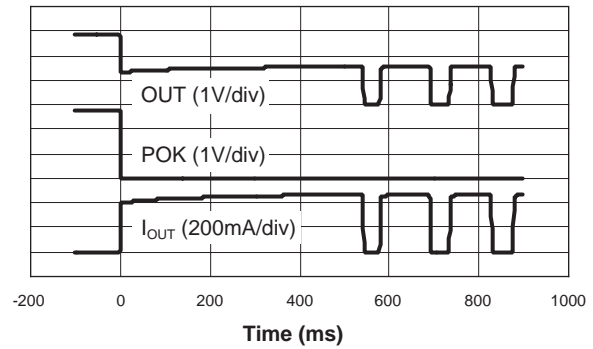

EN Threshold vs. Input Voltage

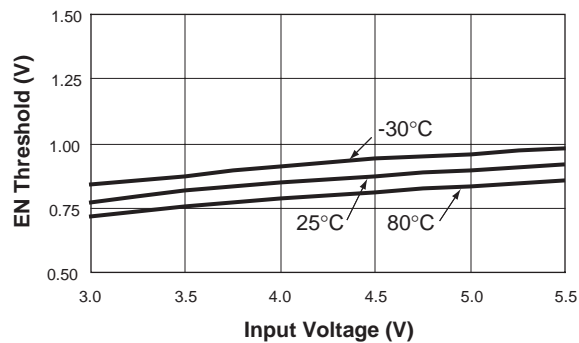

Functional Block Diagram

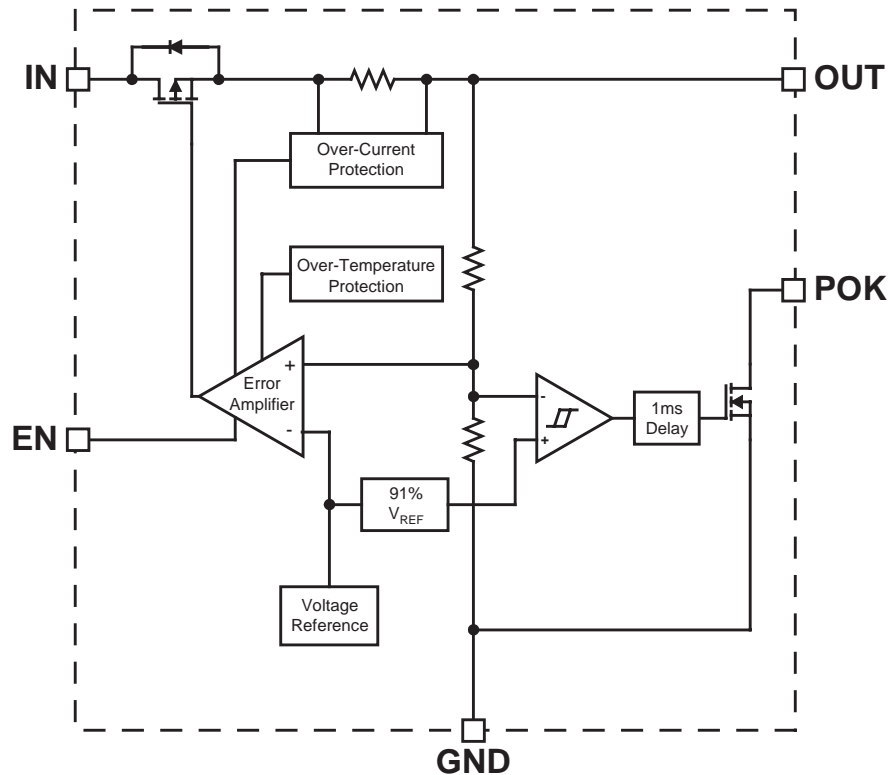

Functional Description

The AAT3223 is intended for LDO regulator applications where output current load requirements range from no load to 250mA. The advanced circuit design of the AAT3223 has been optimized for very low quiescent or ground current consumption, making it ideal for use in power management systems in small battery-operated devices. The typical quiescent current level is just 1.1µA. The AAT3223 also contains an enable circuit, which has been provided to shut down the LDO regulator for additional power conservation in portable products. In the shutdown state, the LDO draws less than 1µA from the input supply.

The Power-OK function has been incorporated to allow notification to application circuits when the output voltage falls out of regulation. If the output voltage falls below the regulation threshold limit, which is compared to a level set by the internal voltage reference, the POK pin is pulled to ground through an N-channel MOSFET.

The LDO also demonstrates excellent power supply ripple rejection, and load and line transient response characteristics. The AAT3223 is a high performance LDO regulator that is especially well suited for circuit applications that are sensitive to load circuit power consumption and extended battery life.

The LDO regulator output has been specifically optimized to function with low-cost, low equivalent series resistance (ESR) ceramic capacitors; however, the design will allow for operation over a wide range of capacitor types.

The AAT3223 has complete short-circuit and thermal protection. The integral combination of these two internal protection circuits gives the AAT3223 a comprehensive safety system to guard against extreme adverse operating conditions. Device power dissipation is limited to the package type and thermal dissipation properties. Refer to the Thermal Considerations section of this datasheet for details on device operation at maximum output current loads.

Applications Information

To assure the maximum possible performance is obtained from the AAT3223, please refer to the following application recommendations.

Input Capacitor

Typically, a 1 μ F or larger capacitor is recommended for C_{IN} in most applications. A C_{IN} capacitor is not required for basic LDO regulator operation. However, if the AAT3223 is physically located any distance more than one or two centimeters from the input power source, a C_{IN} capacitor will be needed for stable operation. C_{IN} should be located as closely to the device V_{IN} pin as practically possible. C_{IN} values greater than 1 μ F will offer superior input line transient response and will assist in maximizing the power supply ripple rejection.

Ceramic, tantalum, or aluminum electrolytic capacitors may be selected for C_{IN} , as there is no specific capacitor ESR requirement. For 250mA LDO regulator output operation, ceramic capacitors are recommended for C_{IN} due to their inherent capability over tantalum capacitors to withstand input current surges from low impedance sources, such as batteries in portable devices.

Output Capacitor

For proper load voltage regulation and operational stability, a capacitor is required between pins V_{OUT} and GND. The C_{OUT} capacitor connection to the LDO regulator ground pin should be made as direct as practically possible for maximum device performance. The AAT3223 has been specifically designed to function with very low ESR ceramic capacitors. Although the device is intended to operate with these low ESR capacitors, it is stable over a wide range of capacitor ESR, thus it will also work with some higher ESR tantalum or aluminum electrolytic capacitors. However, for best performance, ceramic capacitors are recommended.

The value of C_{OUT} typically ranges from 0.47 μ F to 10 μ F; however, 1 μ F is sufficient for most operating conditions.

If large output current steps are required by an application, then an increased value for C_{OUT} should be considered. The amount of capacitance

needed can be calculated from the step size of the change in output load current expected and the voltage excursion that the load can tolerate.

The total output capacitance required can be calculated using the following formula:

$$C_{OUT} = \frac{\Delta I}{\Delta V} \times 15\mu F$$

Where:

ΔI = maximum step in output current

ΔV = maximum excursion in voltage that the load can tolerate

Note that use of this equation results in capacitor values approximately two to four times the typical value needed for an AAT3223 at room temperature. The increased capacitor value is recommended if tight output tolerances must be maintained over extreme operating conditions and maximum operational temperature excursions. If tantalum or aluminum electrolytic capacitors are used, the capacitor value should be increased to compensate for the substantial ESR inherent to these capacitor types.

Capacitor Characteristics

Ceramic composition capacitors are highly recommended over all other types of capacitors for use with the AAT3223. Ceramic capacitors offer many advantages over their tantalum and aluminum electrolytic counterparts. A ceramic capacitor typically has very low ESR, is lower cost, has a smaller PCB footprint, and is non-polarized. Line and load transient response of the LDO regulator is improved by using low-ESR ceramic capacitors. Since ceramic capacitors are non-polarized, they are less prone to damage if incorrectly connected.

Equivalent Series Resistance: ESR is a very important characteristic to consider when selecting a capacitor. ESR is the internal series resistance associated with a capacitor that includes lead resistance, internal connections, capacitor size and area, material composition, and ambient temperature. Typically, capacitor ESR is measured in milliohms for ceramic capacitors and can range to more than several ohms for tantalum or aluminum electrolytic capacitors.

Ceramic Capacitor Materials: Ceramic capacitors less than 0.1 μ F are typically made from NPO or C0G materials. NPO and C0G materials generally have tight tolerance and are very stable over temperature. Larger capacitor values are usually composed of X7R, X5R, Z5U, or Y5V dielectric materials. Large ceramic capacitors (i.e., greater than 2.2 μ F) are often available in low-cost Y5V and Z5U dielectrics. These two material types are not recommended for use with LDO regulators since the capacitor tolerance can vary more than $\pm 50\%$ over the operating temperature range of the device. A 2.2 μ F Y5V capacitor could be reduced to 1 μ F over the full operating temperature range. This can cause problems for circuit operation and stability. X7R and X5R dielectrics are much more desirable. The temperature tolerance of X7R dielectric is better than $\pm 15\%$.

Capacitor area is another contributor to ESR. Capacitors that are physically large in size will have a lower ESR when compared to a smaller sized capacitor of equivalent material and capacitance value. These larger devices can also improve circuit transient response when compared to an equal value capacitor in a smaller package size.

Consult capacitor vendor datasheets carefully when selecting capacitors for use with LDO regulators.

Enable Function

The AAT3223 features an LDO regulator enable / disable function. This pin (EN) is compatible with CMOS logic. For a logic high signal, the EN control level must be greater than 2.0V. A logic low signal is asserted when the voltage on the EN pin falls below 0.5V. For example, the active high version AAT3223 will turn on when a logic high is applied to the EN pin. If the enable function is not needed in a specific application, it may be tied to the respective voltage level to keep the LDO regulator in a continuously on state; e.g., the active high version AAT3223 will tie V_{IN} to EN to remain on.

Power-OK Function

The Power-OK (POK) function is a very useful basic active low error flag. When the AAT3223 output voltage level is within regulation limits, the POK output pin is a high impedance and should be tied high to the LDO output through a high value

resistor (100k Ω is a good resistor value for this purpose). An internal comparator has a reference threshold set to trigger at 10% of the nominal AAT3223 output voltage. If the output voltage level drops below this preset threshold, the POK function will become active and turn on an open-drain N-channel MOSFET to pull the POK output pin to ground. There is a fixed 1ms delay circuit between the POK comparator output and the N-channel MOSFET gate. The purpose of the delay is to prevent a false triggering of the POK output during device turn-on or during very short duration load transient events. If necessary, additional POK flag delay can be added by placing a capacitor in parallel with the POK pull-up resistor. The additional delay time will be set by the RC time constant, the pull-up resistor, and parallel capacitor values.

When the AAT3223 is in the shutdown state with the EN pin low, the POK pin becomes low impedance. The LDO output will be discharged through the high value POK pull-up resistor. When entering the shutdown state, there is no delay associated with the POK output; the open-drain device turns on immediately.

This offers the added advantage of having a hard application turn-off when the LDO regulator is turned off. This additional function has no adverse effect on regulator turn-on time.

Short-Circuit and Thermal Protection

The AAT3223 is protected by both current limit and over-temperature protection circuitry. The internal short-circuit current limit is designed to activate when the output load demand exceeds the maximum rated output. If a short-circuit condition were to continually draw more than the current limit threshold, the LDO regulator's output voltage would drop to a level necessary to supply the current demanded by the load. Under short-circuit or other over-current operating conditions, the output voltage would drop and the AAT3223's die temperature would rapidly increase. Once the regulator's power dissipation capacity has been exceeded and the internal die temperature reaches approximately 140°C, the system thermal protection circuit will become active. The internal thermal protection circuit will actively turn off the LDO regulator output pass device to prevent the possibility of over-temperature damage. The LDO regulator output will

remain in a shutdown state until the internal die temperature falls back below the 140°C trip point.

The interaction between the short-circuit and thermal protection systems allows the LDO regulator to withstand indefinite short-circuit conditions without sustaining permanent damage.

No-Load Stability

The AAT3223 is designed to maintain output voltage regulation and stability under operational no-load conditions. This is an important characteristic for applications where the output current may drop to zero. An output capacitor is required for stability under no-load operating conditions. Refer to the Output Capacitor section of this datasheet for recommended typical output capacitor values.

Thermal Considerations and High Output Current Applications

The AAT3223 is designed to deliver a continuous output load current up to 250mA under normal operating conditions. The limiting characteristic for the maximum output load safe operating area is essentially package power dissipation and the internal preset thermal limit of the device. In order to obtain high operating currents, careful device layout and circuit operating conditions must be taken into account. The following discussions will assume the LDO regulator is mounted on a printed circuit board utilizing the minimum recommended footprint and the printed circuit board is 0.062-inch thick FR4 material with one ounce copper.

At any given ambient temperature (T_A), the maximum package power dissipation can be determined by the following equation:

$$P_{D(MAX)} = \frac{T_{J(MAX)} - T_A}{\theta_{JA}}$$

Constants for the AAT3223 are $T_{J(MAX)}$, the maximum junction temperature for the device which is 125°C, and $\theta_{JA} = 150^\circ\text{C/W}$, the package thermal

resistance. Typically, maximum conditions are calculated at the maximum operating temperature where $T_A = 85^\circ\text{C}$, under normal ambient conditions $T_A = 25^\circ\text{C}$. Given $T_A = 85^\circ\text{C}$, the maximum package power dissipation is 267mW. At $T_A = 25^\circ\text{C}$, the maximum package power dissipation is 667mW.

The maximum continuous output current for the AAT3223 is a function of the package power dissipation and the input-to-output voltage drop across the LDO regulator. Refer to the following simple equation:

$$I_{OUT(MAX)} < \frac{P_{D(MAX)}}{V_{IN} - V_{OUT}}$$

For example, if $V_{IN} = 5\text{V}$, $V_{OUT} = 2.8\text{V}$ and $T_A = 25^\circ\text{C}$, $I_{OUT(MAX)} < 267\text{mA}$. The output short-circuit protection threshold is set between 300mA and 450mA. If the output load current were to exceed 267mA or if the ambient temperature were to increase, the internal die temperature would increase. If the condition remained constant and the short-circuit protection did not activate, there would be a potential damage hazard to the LDO regulator since the thermal protection circuit will only activate after a short-circuit event occurs on the LDO regulator output.

To determine the maximum input voltage for a given load current, refer to the following equation. This calculation accounts for the total power dissipation of the LDO regulator, including that caused by ground current.

$$P_{D(MAX)} = (V_{IN} - V_{OUT})I_{OUT} + (V_{IN} \times I_{GND})$$

This formula can be solved for V_{IN} to determine the maximum input voltage.

$$V_{IN(MAX)} = \frac{P_{D(MAX)} + (V_{OUT} \times I_{OUT})}{I_{OUT} + I_{GND}}$$

The following is an example for an AAT3223 set for a 2.8V output:

$$\begin{aligned} V_{OUT} &= 2.9V \\ I_{OUT} &= 250mA \\ I_{GND} &= 1.1\mu A \\ V_{IN(MAX)} &= \frac{667mW + (2.8V \times 150mA)}{150mA + 1.1\mu A} \\ V_{IN(MAX)} &= 9.11V \end{aligned}$$

From the discussion above, $P_{D(MAX)}$ was determined to equal 667mW at $T_A = 25^\circ C$.

Thus, the AAT3223 can sustain a constant 2.8V output at a 150mA load current as long as V_{IN} is $\leq 9.11V$ at an ambient temperature of $25^\circ C$. 5.5V is the maximum input operating voltage for the AAT3223, thus at $25^\circ C$, the device would not have any thermal concerns or operational $V_{IN(MAX)}$ limits.

This situation can be different at $85^\circ C$. The following is an example for an AAT3223 set for a 2.8V output at $85^\circ C$:

$$\begin{aligned} V_{OUT} &= 2.9V \\ I_{OUT} &= 150mA \\ I_{GND} &= 1.1\mu A \\ V_{IN(MAX)} &= \frac{267mW + (2.8V \times 150mA)}{150mA + 1.1\mu A} \\ V_{IN(MAX)} &= 4.58V \end{aligned}$$

From the discussion above, $P_{D(MAX)}$ was determined to equal 267mW at $T_A = 85^\circ C$.

Higher input-to-output voltage differentials can be obtained with the AAT3223, while maintaining device functions in the thermal safe operating area. To accomplish this, the device thermal resistance must be reduced by increasing the heat sink area or by operating the LDO regulator in a duty-cycled mode.

For example, an application requires $V_{IN} = 5.0V$ while $V_{OUT} = 2.8V$ at a 150mA load and $T_A = 85^\circ C$. V_{IN} is greater than 4.58V, which is the maximum safe continuous input level for $V_{OUT} = 2.8V$ at 150mA for $T_A = 85^\circ C$. To maintain this high input voltage and output current level, the LDO regulator must be operated in a duty-cycled mode. Refer to the following calculation for duty-cycle operation:

$$\begin{aligned} I_{GND} &= 1.1\mu A \\ I_{OUT} &= 150mA \\ V_{IN} &= 5.0V \\ V_{OUT} &= 2.8V \\ \%DC &= 100 \frac{P_{D(MAX)}}{(V_{IN} - V_{OUT})I_{OUT} + (V_{IN} \times I_{GND})} \\ \%DC &= 100 \frac{267mW}{(5.0V - 2.8V)150mA + (5.0V \times 1.1\mu A)} \\ \%DC &= 80.9\% \end{aligned}$$

$P_{D(MAX)}$ was assumed to be 267mW.

For a 150mA output current and a 2.2V drop across the AAT3223 at an ambient temperature of $85^\circ C$, the maximum on-time duty cycle for the device would be 80.9%.

The following family of curves shows the safe operating area for duty-cycled operation from ambient room temperature to the maximum operating level.

Device Duty Cycle vs. V_{DROP}
($V_{DROP} = 2.8V @ 25^{\circ}C$)

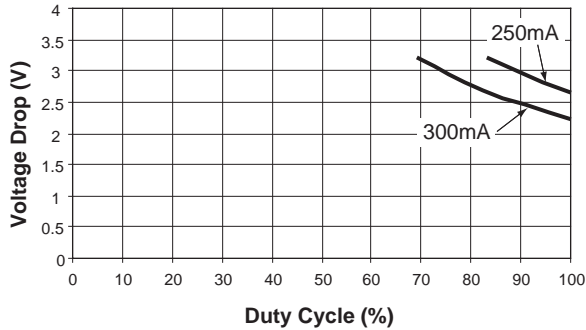

Device Duty Cycle vs. V_{DROP}
($V_{DROP} = 2.8V @ 50^{\circ}C$)

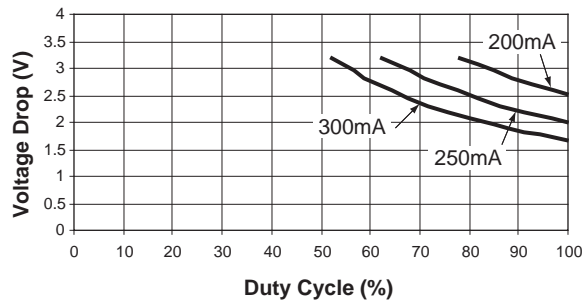

Device Duty Cycle vs. V_{DROP}
($V_{DROP} = 2.8V @ 85^{\circ}C$)

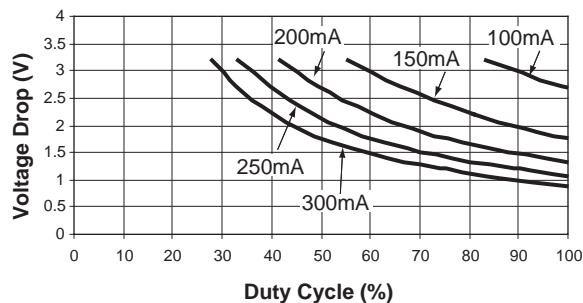

High Peak Output Current Applications

Some applications require the LDO regulator to operate at continuous nominal levels with short duration, high-current peaks. The duty cycles for both output current levels must be taken into account. To do so, one would first need to calculate the power dissipation at the nominal continuous level, then factor in the addition power dissipation due to the short duration, high-current peaks.

For example, a 2.8V system using a AAT3223IGU-2.8-T1 operates at a continuous 100mA load current level and has short 250mA current peaks. The current peak occurs for 378 μ s out of a 4.61ms period. It will be assumed the input voltage is 5.0V.

First, the current duty cycle percentage must be calculated:

$$\% \text{ Peak Duty Cycle: } X/100 = 378\text{ms}/4.61\text{ms}$$

$$\% \text{ Peak Duty Cycle} = 8.2\%$$

The LDO regulator will be under the 100mA load for 91.8% of the 4.61ms period and have 150mA peaks occurring for 8.2% of the time. Next, the continuous nominal power dissipation for the 100mA load should be determined and then multiplied by the duty cycle to conclude the actual power dissipation over time.

$$P_{D(MAX)} = (V_{IN} - V_{OUT})I_{OUT} + (V_{IN} \times I_{GND})$$

$$P_{D(100mA)} = (5.0V - 2.8V)100mA + (5.0V \times 1.1\mu A)$$

$$P_{D(100mA)} = 225.5mW$$

$$P_{D(91.8\%D/C)} = \%DC \times P_{D(100mA)}$$

$$P_{D(91.8\%D/C)} = 0.918 \times 225.5mW$$

$$P_{D(91.8\%D/C)} = 207mW$$

The power dissipation for a 100mA load occurring for 91.8% of the duty cycle will be 207mW. Now the power dissipation for the remaining 8.2% of the duty cycle at the 150mA load can be calculated:

$$P_{D(MAX)} = (V_{IN} - V_{OUT})I_{OUT} + (V_{IN} \times I_{GND})$$

$$P_{D(250mA)} = (5.0V - 2.8V)250mA + (5.0V \times 1.1\mu A)$$

$$P_{D(250mA)} = 550mW$$

$$P_{D(8.2\%D/C)} = \%DC \times P_{D(250mA)}$$

$$P_{D(8.2\%D/C)} = 0.082 \times 550mW$$

$$P_{D(8.2\%D/C)} = 45.1mW$$

The power dissipation for a 150mA load occurring for 8.2% of the duty cycle will be 20.9mW. Finally, the two power dissipation levels can be summed to determine the total true power dissipation under the varied load.

$$P_{D(\text{total})} = P_{D(100\text{mA})} + P_{D(250\text{mA})}$$

$$P_{D(\text{total})} = 207\text{mW} + 45.1\text{mW}$$

$$P_{D(\text{total})} = 252.1\text{mW}$$

The maximum power dissipation for the AAT3223 operating at an ambient temperature of 85°C is 267mW. The device in this example will have a total power dissipation of 252.1mW. This is within the thermal limits for safe operation of the device.

Printed Circuit Board Layout Recommendations

In order to obtain the maximum performance from the AAT3223 LDO regulator, careful attention should be given to the printed circuit board layout. If grounding connections are not properly made, power supply ripple rejection and LDO regulator transient response can be compromised.

The LDO regulator external capacitors C_{IN} and C_{OUT} should be connected as directly as possible to the ground pin of the LDO regulator. For maximum performance with the AAT3223, the ground pin connection should then be made directly back to the ground or common of the source power supply. If a direct ground return path is not possible due to printed circuit board layout limitations, the LDO ground pin should then be connected to the common ground plane in the application layout.

Ordering Information

Output Voltage	Enable	Package	Marking ¹	Part Number (Tape and Reel) ²
1.8V	Active high	SOT23-6	EGXY	AAT3223IGU-1.8-T1
2.7V	Active high	SOT23-6	GGXY	AAT3223IGU-2.7-T1
2.8V	Active high	SOT23-6	EHXY	AAT3223IGU-2.8-T1
2.85V	Active high	SOT23-6	GFXYY	AAT3223IGU-2.85-T1
3.0V	Active high	SOT23-6	GEXYY	AAT3223IGU-3.0-T1
3.3V	Active high	SOT23-6	GQXY	AAT3223IGU-3.3-T1



All AnalogicTech products are offered in Pb-free packaging. The term “Pb-free” means semiconductor products that are in compliance with current RoHS standards, including the requirement that lead not exceed 0.1% by weight in homogeneous materials. For more information, please visit our website at <http://www.analogictech.com/pbfree>.

Package Information

SOT23-6

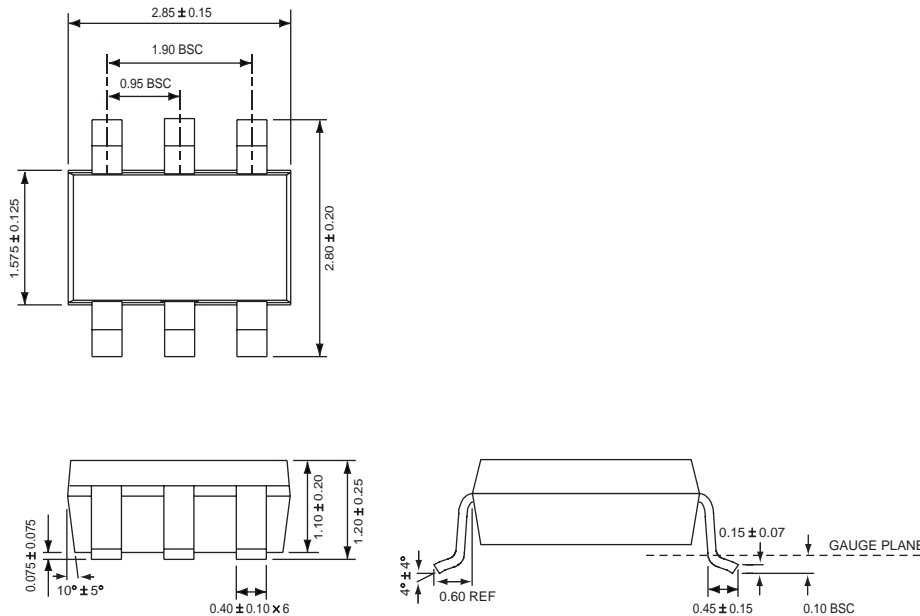

All dimensions in millimeters.

1. XYY = assembly and date code.
2. Sample stock is generally held on all part numbers listed in **BOLD**.

© Advanced Analogic Technologies, Inc.

AnalogicTech cannot assume responsibility for use of any circuitry other than circuitry entirely embodied in an AnalogicTech product. No circuit patent licenses, copyrights, mask work rights, or other intellectual property rights are implied. AnalogicTech reserves the right to make changes to their products or specifications or to discontinue any product or service without notice. Customers are advised to obtain the latest version of relevant information to verify, before placing orders, that information being relied on is current and complete. All products are sold subject to the terms and conditions of sale supplied at the time of order acknowledgement, including those pertaining to warranty, patent infringement, and limitation of liability. AnalogicTech warrants performance of its semiconductor products to the specifications applicable at the time of sale in accordance with AnalogicTech's standard warranty. Testing and other quality control techniques are utilized to the extent AnalogicTech deems necessary to support this warranty. Specific testing of all parameters of each device is not necessarily performed.

Advanced Analogic Technologies, Inc.
830 E. Arques Avenue, Sunnyvale, CA 94085
Phone (408) 737-4600
Fax (408) 737-4611