

General Description

The AAT4250 SmartSwitch is a member of AnalogicTech's Application Specific Power MOSFET™ (ASPM™) product family. It is a slew rate controlled P-channel MOSFET power switch designed for high-side load switching applications. This switch operates with an input voltage range from 1.8V to 5.5V, making it ideal for 2.5V, 3.3V, or 5V systems. The part features 1.5ms turn-on and 10μs turn-off time. The AAT4250 has an under-voltage lockout which turns off the switch when an under-voltage condition exists. Input logic levels are TTL compatible. The quiescent supply current is very low, typically 2μA. In shutdown mode, the supply current is typically reduced to 0.1μA or less.

The AAT4250 is available in a Pb-free, 5-pin SOT23 (SOT25) package or a Pb-free, 8-pin SC70JW package and is specified over the -40°C to +85°C temperature range.

Features

- 1.8V to 5.5V Input Voltage Range
- 120mΩ (5V) Typical $R_{DS(ON)}$
- Low Quiescent Current:
 - Typical 2μA
 - Typical 0.1μA with Enable Off
- Only 2.0V Needed for ON/OFF Control
- Temperature Range: -40°C to +85°C
- 5kV ESD Rating
- SOT23-5 or SC70JW-8 Package

Applications

- Hot Swap Supplies
- Notebook Computers
- Personal Communication Devices

Typical Application

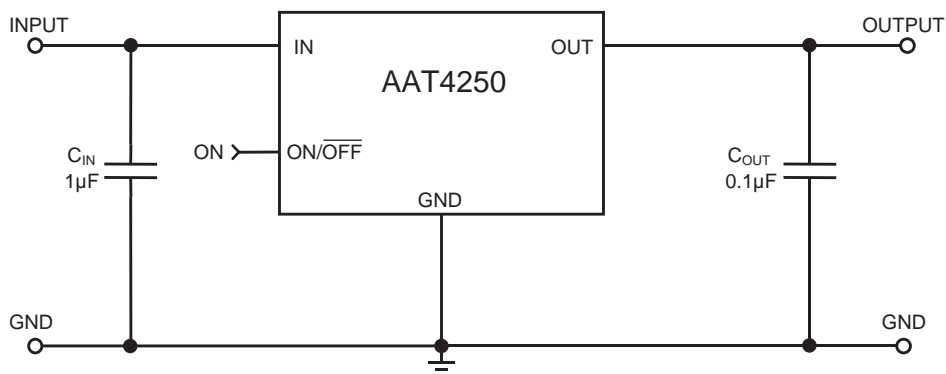

Pin Descriptions

Pin #		Symbol	Function
SOT23-5	SC70JW-8		
1	1	OUT	P-channel MOSFET drain.
2	2, 3, 4, 5	GND	Ground connection.
3	N/A	N/C	Not internally connected.
4	6	ON/ $\overline{\text{OFF}}$	Active-high enable input. Logic high turns the switch on.
5	7, 8	IN	P-channel MOSFET source.

Pin Configuration

SOT23-5 (SOT25)
(Top View)

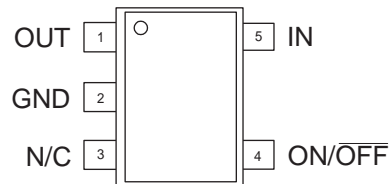

SC70JW-8
(Top View)

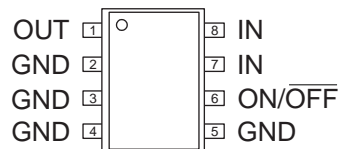

Absolute Maximum Ratings¹

$T_A = 25^\circ\text{C}$, unless otherwise noted.

Symbol	Description	Value	Units
V_{IN}	IN to GND	-0.3 to 6	V
V_{ON}	ON/OFF to GND	-0.3 to 6	V
V_{OUT}	OUT to GND	-0.3 to $V_{IN} + 0.3$	V
I_{MAX}	Maximum Continuous Switch Current	1.7	A
I_{DM}	Maximum Pulsed Current	$IN \geq 2.5V$	4
		$IN < 2.5V$	2
T_J	Operating Junction Temperature Range	-40 to 150	$^\circ\text{C}$
T_{LEAD}	Maximum Soldering Temperature (at leads)	300	$^\circ\text{C}$
V_{ESD}	ESD Rating ² - HBM	5000	V

Thermal Characteristics³

Symbol	Description	Value	Units
Θ_{JA}	Thermal Resistance	150	$^\circ\text{C}/\text{W}$
P_D	Power Dissipation	667	mW

1. Stresses above those listed in Absolute Maximum Ratings may cause permanent damage to the device. Functional operation at conditions other than the operating conditions specified is not implied. Only one Absolute Maximum Rating should be applied at any one time.
2. Human body model is a 100pF capacitor discharged through a 1.5k Ω resistor into each pin.
3. Mounted on an AAT4250 demo board in still 25 $^\circ\text{C}$ air.

Electrical Characteristics

$V_{IN} = 5V$, $T_A = -40^{\circ}C$ to $+85^{\circ}C$, unless otherwise noted. Typical values are $T_A = 25^{\circ}C$.

Symbol	Description	Conditions	Min	Typ	Max	Units
V_{IN}	Operation Voltage		1.8 ¹		5.5	V
I_Q	Quiescent Current	$V_{IN} = 5V$, $\overline{ON/OFF} = V_{IN}$, $I_{OUT} = 0$		2	4	μA
$I_{Q(OFF)}$	Off Supply Current	$\overline{ON/OFF} = GND$, $V_{IN} = 5V$, OUT Open			1	μA
$I_{SD(OFF)}$	Off Switch Current	$\overline{ON/OFF} = GND$, $V_{IN} = 5V$, $V_{OUT} = 0$		0.1	1	μA
V_{UVLO}	Under-Voltage Lockout	V_{IN} Falling	1.0	1.5	1.8	V
$V_{UVLO(hys)}$	Under-Voltage Lockout Hysteresis			250		mV
$R_{DS(ON)}$	On Resistance	$V_{IN} = 5V$, $T_A = 25^{\circ}C$		120	175	m Ω
		$V_{IN} = 3V$, $T_A = 25^{\circ}C$		135	200	
		$V_{IN} = 1.8V$		165		
TC_{RDS}	On Resistance Temperature Coefficient			2800		ppm/ $^{\circ}C$
V_{IL}	$\overline{ON/OFF}$ Input Logic Low Voltage	$V_{IN} = 2.7V$ to $5.5V^2$			0.8	V
V_{IH}	$\overline{ON/OFF}$ Input Logic High Voltage	$V_{IN} = 2.7V$ to $\leq 4.2V$	2.0			V
		$V_{IN} = >4.2V$ to $5.5V$	2.4			
I_{SINK}	ON Input Leakage	$V_{ON} = 5V$		0.01	1	μA
T_D	Output Turn-On Delay Time			300		μs
T_{DOFF}	Turn-Off Delay Time	$V_{IN} = 5V$, $R_{LOAD} = 10\Omega$			10	μs
		$V_{IN} = 3V$, $R_{LOAD} = 5\Omega$			10	
T_{ON}	Turn-On Rise Time	$V_{IN} = 5V$, $R_{LOAD} = 16.5\Omega$, $T_A = 0$ to $50^{\circ}C$	1000			μs
		$V_{IN} = 5V$, $R_{LOAD} = 10\Omega$, $C_{OUT} = 0.1\mu F$		1500		
		$V_{IN} = 3V$, $R_{LOAD} = 5\Omega$, $C_{OUT} = 0.1\mu F$		1500		

1. Part requires minimum start-up of $V_{IN} \geq 2.0V$ to ensure operation down to 1.8V.
 2. For V_{IN} outside this range, consult typical ON/OFF threshold curve.

Typical Characteristics

Unless otherwise noted, $V_{IN} = 5V$, $T_A = 25^\circ C$.

Quiescent Current vs. Temperature

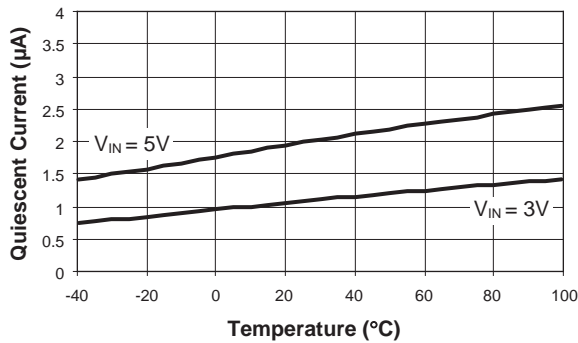

Quiescent Current vs. Input Voltage

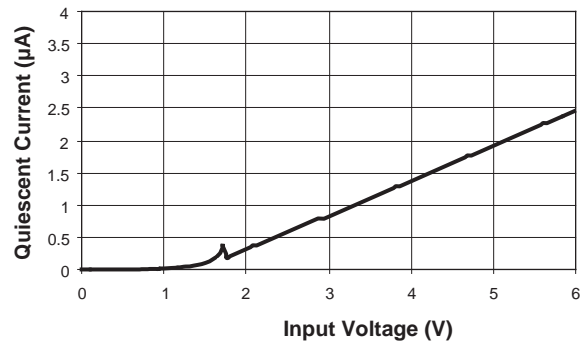

Off-Supply Current vs. Temperature

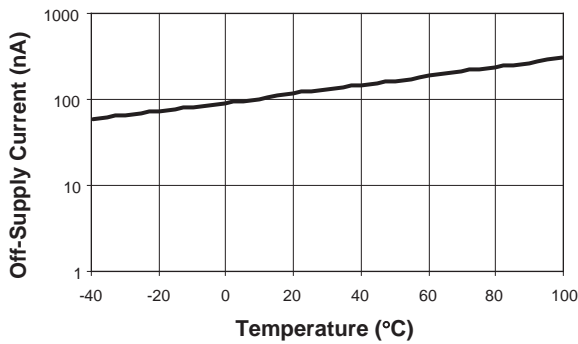

Off-Switch Current vs. Temperature

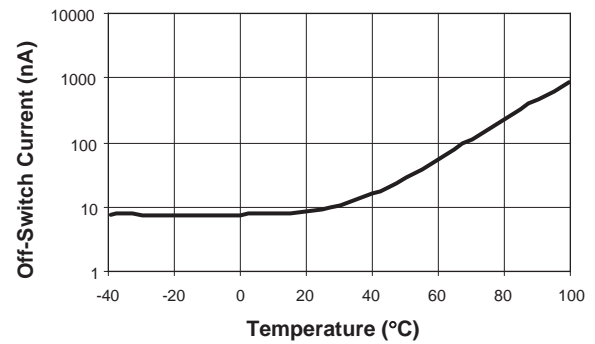

Turn-Off Time vs. Temperature
($C_{IN} = 1\mu F$; $C_{OUT} = 0.1\mu F$)

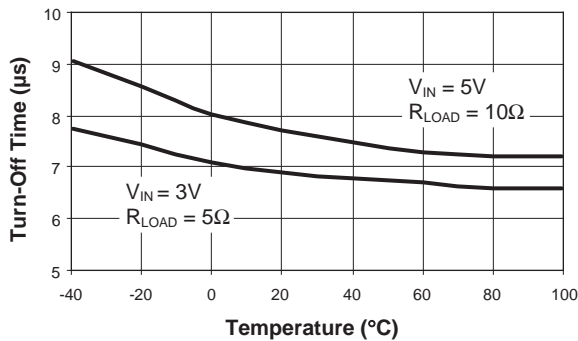

Turn-On Time vs. Temperature
($C_{IN} = 1\mu F$; $C_{OUT} = 0.1\mu F$)

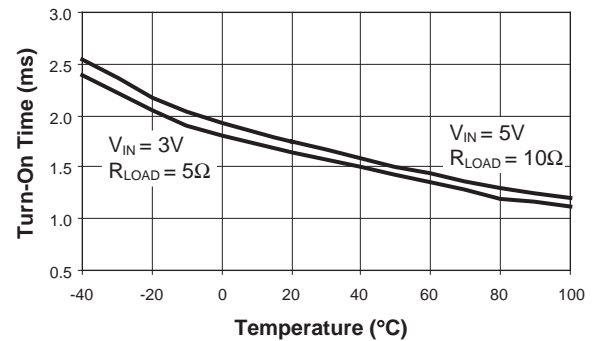

Typical Characteristics

Unless otherwise noted, $V_{IN} = 5V$, $T_A = 25^\circ C$.

Turn-On Waveforms
($C_{IN} = 1\mu F$; $C_{OUT} = 0.1\mu F$; $V_{IN} = 3V$)

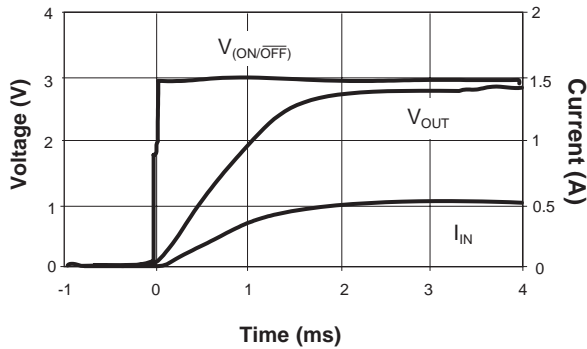

Turn-On Waveforms
($C_{IN} = 1\mu F$; $C_{OUT} = 0.1\mu F$; $V_{IN} = 5V$)

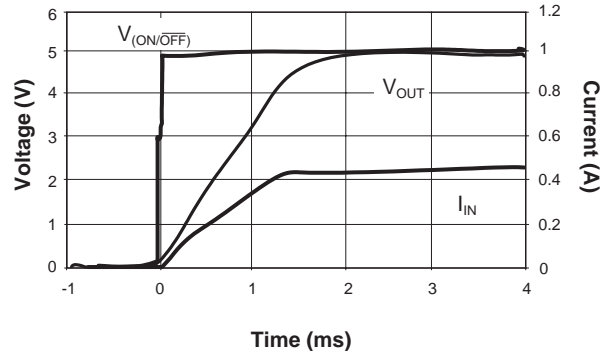

Turn-On Waveforms
($C_{IN} = 1\mu F$; $C_{OUT} = 10\mu F$; $V_{IN} = 3V$)

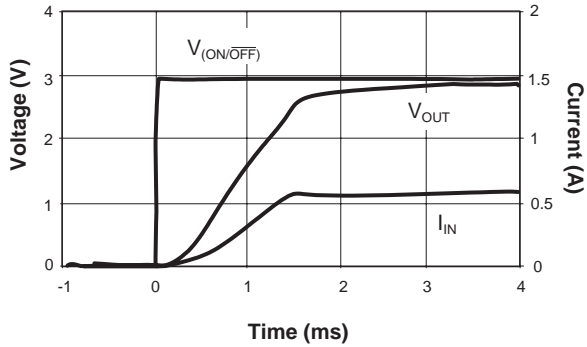

Turn-On Waveforms
($C_{IN} = 1\mu F$; $C_{OUT} = 10\mu F$; $V_{IN} = 5V$)

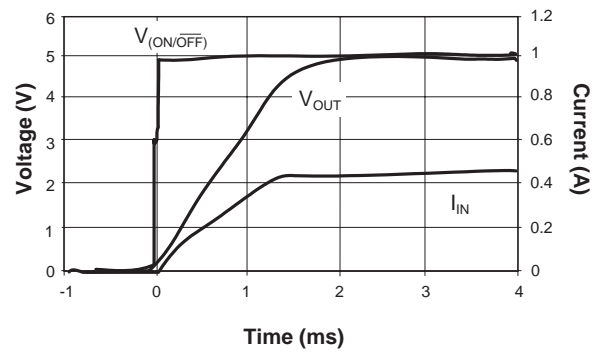

Turn-Off Waveforms
($C_{IN} = 1\mu F$; $C_{OUT} = 1\mu F$; $V_{IN} = 3V$)

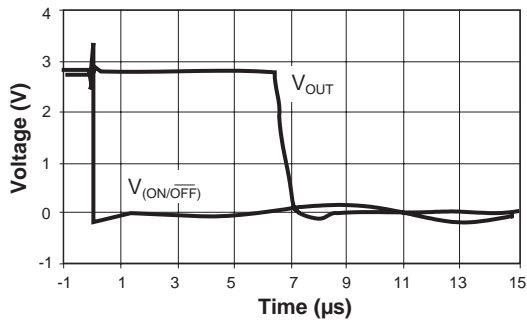

Turn-Off Waveforms
($C_{IN} = 1\mu F$; $C_{OUT} = 1\mu F$; $V_{IN} = 5V$)

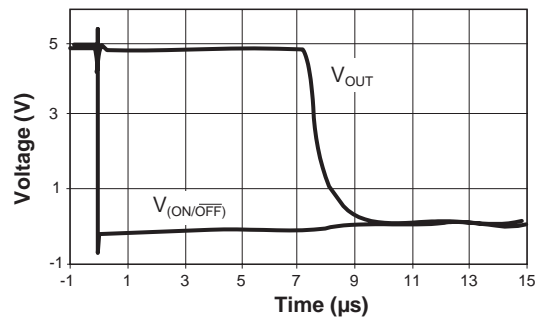

Typical Characteristics

Unless otherwise noted, $V_{IN} = 5V$, $T_A = 25^\circ C$.

$R_{DS(ON)}$ vs. Temperature

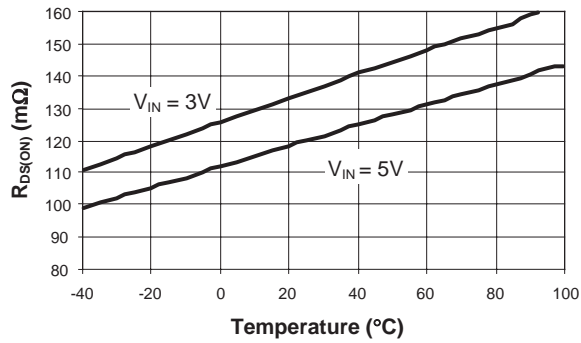

$R_{DS(ON)}$ vs. Input Voltage

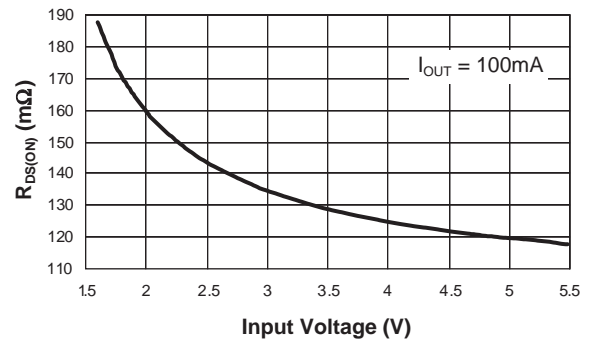

Typical ON/OFF Threshold vs. Input Voltage

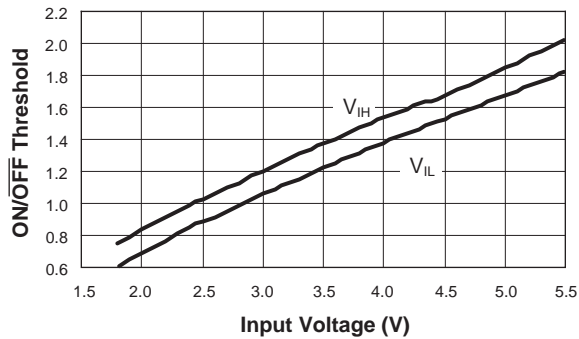

Functional Block Diagram

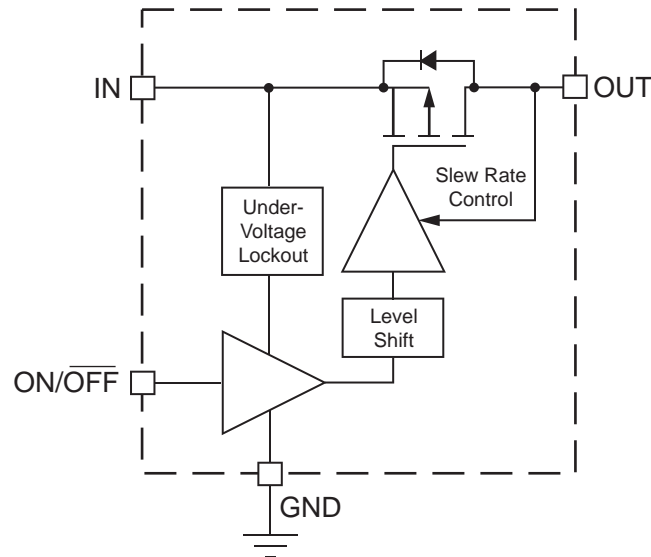

Functional Description

The AAT4250 is a slew rate controlled P-channel MOSFET power switch designed for high-side load switching applications. It operates with input voltages ranging from 1.8V to 5.5V which, along with its extremely low operating current, makes it ideal for battery-powered applications. In cases where the input voltage drops below 1.8V, the AAT4250 MOSFET is protected from entering the saturated region of operation by automatically shutting down. In addition, the TTL compatible ON/OFF pin makes the AAT4250 an ideal level-shifted load switch. The slew rate controlling feature eliminates inrush current when the MOSFET is turned on, allowing the AAT4250 to be used with a small input capacitor, or no input capacitor at all. During slewing, the current ramps linearly until it reaches the level required for the output load condition. The proprietary control method works by careful control and monitoring of the MOSFET gate voltage. When the device is switched ON, the gate voltage is quickly increased to the threshold level of the MOSFET. Once at this level, the current begins to slew as the gate voltage is slowly increased until the MOSFET becomes fully enhanced. Once it has reached this point, the gate is quickly increased to the full input voltage and $R_{DS(ON)}$ is minimized.

Applications Information

Input Capacitor

A 1 μ F or larger capacitor is typically recommended for C_{IN} in most applications. A C_{IN} capacitor is not required for basic operation; however, it is useful in preventing load transients from affecting upstream circuits. C_{IN} should be located as close to the device V_{IN} pin as practically possible. Ceramic, tantalum, or aluminum electrolytic capacitors may be selected for C_{IN} . There is no specific capacitor equivalent series resistance (ESR) requirement for C_{IN} . However, for higher current operation, ceramic capacitors are recommended for C_{IN} due to their inherent capability over tantalum capacitors to withstand input current surges from low-impedance sources, such as batteries in portable devices.

Output Capacitor

For proper slew operation, a 0.1 μ F capacitor or greater is required between V_{OUT} and GND.

Likewise, with the output capacitor, there is no specific capacitor ESR requirement. If desired, C_{OUT} may be increased without limit to accommodate any load transient condition without adversely affecting the slew rate.

Enable Function

The AAT4250 features an enable / disable function. This pin (ON) is active high and is compatible with TTL or CMOS logic. To assure the load switch will turn on, the ON control level must be greater than 2.0V. The load switch will go into shutdown mode when the voltage on the ON pin falls below 0.8V. When the load switch is in shutdown mode, the OUT pin is tri-stated, and quiescent current drops to leakage levels below 1µA.

Reverse Output-to-Input Voltage Conditions and Protection

Under normal operating conditions, a parasitic diode exists between the output and input of the load switch. The input voltage should always remain greater than the output load voltage, maintaining a reverse bias on the internal parasitic diode. Conditions where V_{OUT} might exceed V_{IN} should be avoided since this would forward bias the internal parasitic diode and allow excessive current flow into the V_{OUT} pin, possibly damaging the load switch.

In applications where there is a possibility of V_{OUT} exceeding V_{IN} for brief periods of time during normal operation, the use of a larger value C_{IN} capacitor is highly recommended. A larger value of C_{IN} with respect to C_{OUT} will effect a slower C_{IN} decay rate during shutdown, thus preventing V_{OUT} from exceeding V_{IN} . In applications where there is a greater danger of V_{OUT} exceeding V_{IN} for extended periods of time, it is recommended to place a Schottky diode from V_{IN} to V_{OUT} (connecting the cathode to V_{IN} and anode to V_{OUT}). The Schottky diode forward voltage should be less than 0.45V.

Thermal Considerations and High Output Current Applications

The AAT4250 is designed to deliver a continuous output load current. The limiting characteristic for maximum safe operating output load current is package power dissipation. In order to obtain high operating currents, careful device layout and circuit operating conditions must be taken into account.

The following discussions will assume the load switch is mounted on a printed circuit board utilizing the minimum recommended footprint as stated in the Printed Circuit Board Layout Recommendations section of this datasheet.

At any given ambient temperature (T_A), the maximum package power dissipation can be determined by the following equation:

$$P_{D(MAX)} = \frac{T_{J(MAX)} - T_A}{\theta_{JA}}$$

Constants for the AAT4250 are maximum junction temperature ($T_{J(MAX)} = 125^\circ\text{C}$) and package thermal resistance ($\theta_{JA} = 150^\circ\text{C/W}$). Worst case conditions are calculated at the maximum operating temperature, $T_A = 85^\circ\text{C}$. Typical conditions are calculated under normal ambient conditions where $T_A = 25^\circ\text{C}$. At $T_A = 85^\circ\text{C}$, $P_{D(MAX)} = 267\text{mW}$. At $T_A = 25^\circ\text{C}$, $P_{D(MAX)} = 667\text{mW}$.

The maximum continuous output current for the AAT4250 is a function of the package power dissipation and the R_{DS} of the MOSFET at $T_{J(MAX)}$. The maximum R_{DS} of the MOSFET at $T_{J(MAX)}$ is calculated by increasing the maximum room temperature R_{DS} by the R_{DS} temperature coefficient. The temperature coefficient (TC) is 2800ppm/ $^\circ\text{C}$. Therefore, at 125°C :

$$\begin{aligned} R_{DS(MAX)} &= R_{DS(25^\circ\text{C})} \times (1 + \text{TC} \times \Delta T) \\ R_{DS(MAX)} &= 175\text{m}\Omega \times (1 + 0.002800 \times (125^\circ\text{C} - 25^\circ\text{C})) \\ R_{DS(MAX)} &= 224\text{m}\Omega \end{aligned}$$

For maximum current, refer to the following equation:

$$I_{OUT(MAX)} < \left(\frac{P_{D(MAX)}}{R_{DS}} \right)^{\frac{1}{2}}$$

For example, if $V_{IN} = 5\text{V}$, $R_{DS(MAX)} = 224\text{m}\Omega$, and $T_A = 25^\circ\text{C}$, $I_{OUT(MAX)} = 1.7\text{A}$. If the output load current were to exceed 1.7A or if the ambient temperature were to increase, the internal die temperature would increase and the device would be damaged.

Higher peak currents can be obtained with the AAT4250. To accomplish this, the device thermal resistance must be reduced by increasing the heat sink area or by operating the load switch in a duty-cycle manner. Duty cycles with peaks less than 2ms in duration can be considered using the method below.

High Peak Output Current Applications

Some applications require the load switch to operate at a continuous nominal current level with short duration, high-current peaks. Refer to the I_{DM} specification in the Absolute Maximum Ratings table to ensure the AAT4250's maximum pulsed current rating is not exceeded. The duty cycle for both output current levels must be taken into account. To do so, first calculate the power dissipation at the nominal continuous current level, and then add the additional power dissipation due to the short duration, high-current peak scaled by the duty factor.

For example, a 4V system using an AAT4250 operates at a continuous 100mA load current level and has short 2A current peaks, as in a GSM application. The current peak occurs for 576 μ s out of a 4.61ms period.

First, the current duty cycle is calculated:

$$\% \text{ Peak Duty Cycle: } X/100 = 576\mu\text{s}/4.61\text{ms}$$

$$\% \text{ Peak Duty Cycle} = 12.5\%$$

The load current is 100mA for 87.5% of the 4.61ms period and 2A for 12.5% of the period. Since the Electrical Characteristics do not report $R_{DS(MAX)}$ for 4V operation, it must be approximated by consulting the chart of $R_{DS(ON)}$ vs. V_{IN} . The R_{DS} reported for 5V R_{DS} can be scaled by the ratio seen in the chart to derive the R_{DS} for 4V V_{IN} : $175\text{m}\Omega \times 120\text{m}\Omega/115\text{m}\Omega = 183\text{m}\Omega$. Derated for temperature: $183\text{m}\Omega \times (1 + 0.002800 \times (125^\circ\text{C} - 25^\circ\text{C})) = 235\text{m}\Omega$. The power dissipation for a 100mA load is calculated as follows:

$$P_{D(MAX)} = I_{OUT}^2 \times R_{DS}$$

$$P_{D(100\text{mA})} = (100\text{mA})^2 \times 235\text{m}\Omega$$

$$P_{D(100\text{mA})} = 2.35\text{mW}$$

$$P_{D(87.5\%D/C)} = \%DC \times P_{D(100\text{mA})}$$

$$P_{D(87.5\%D/C)} = 0.875 \times 2.35\text{mW}$$

$$P_{D(87.5\%D/C)} = 2.1\text{mW}$$

The power dissipation for 100mA load at 87.5% duty cycle is 2.1mW. Now the power dissipation for the remaining 12.5% of the duty cycle at 2A is calculated:

$$P_{D(MAX)} = I_{OUT}^2 \times R_{DS}$$

$$P_{D(2A)} = (2A)^2 \times 235\text{m}\Omega$$

$$P_{D(2A)} = 940\text{mW}$$

$$P_{D(12.5\%D/C)} = \%DC \times P_{D(2A)}$$

$$P_{D(12.5\%D/C)} = 0.125 \times 940\text{mW}$$

$$P_{D(12.5\%D/C)} = 117.5\text{mW}$$

The power dissipation for 2A load at 12.5% duty cycle is 117mW. Finally, the two power figures are summed to determine the total true power dissipation under the varied load.

$$P_{D(total)} = P_{D(100\text{mA})} + P_{D(2A)}$$

$$P_{D(total)} = 2.1\text{mW} + 117.5\text{mW}$$

$$P_{D(total)} = 120\text{mW}$$

The maximum power dissipation for the AAT4250 operating at an ambient temperature of 85°C is 267mW. The device in this example will have a total power dissipation of 120mW. This is well within the thermal limits for safe operation of the device; in fact, at 85°C, the AAT4250 will handle a 2A pulse for up to 28% duty cycle. At lower ambient temperatures, the duty cycle can be further increased.

Printed Circuit Board Layout Recommendations

For proper thermal management, and to take advantage of the low $R_{DS(ON)}$ of the AAT4250, a few circuit board layout rules should be followed: V_{IN} and V_{OUT} should be routed using wider than normal traces, and GND should be connected to a ground plane. For best performance, C_{IN} and C_{OUT} should be placed close to the package pins.

Evaluation Board Layout

The AAT4250 evaluation layout follows the printed circuit board layout recommendations, and can be used for good applications layout.

Note: Board layout shown is not to scale.

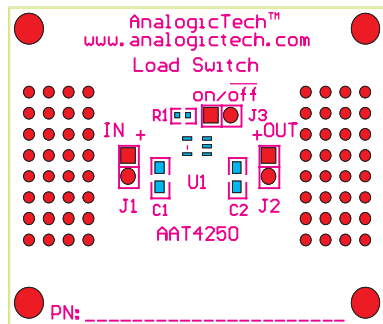

**Figure 1: Evaluation Board
Top Side Silk Screen Layout /
Assembly Drawing.**

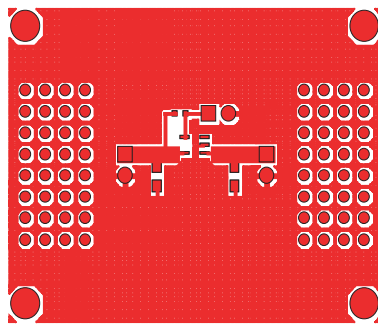

**Figure 2: Evaluation Board
Component Side Layout.**

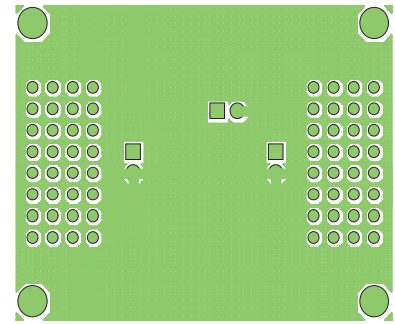

**Figure 3: Evaluation Board
Solder Side Layout.**

Ordering Information

Package	Marking ¹	Part Number (Tape and Reel) ²
SOT23-5 (SOT25)	ACXYY	AAT4250IGV-T1
SC70JW-8	ACXYY	AAT4250IJS-T1



All AnalogicTech products are offered in Pb-free packaging. The term “Pb-free” means semiconductor products that are in compliance with current RoHS standards, including the requirement that lead not exceed 0.1% by weight in homogeneous materials. For more information, please visit our website at <http://www.analogictech.com/pbfree>.

Package Information

SOT23-5 (SOT25)

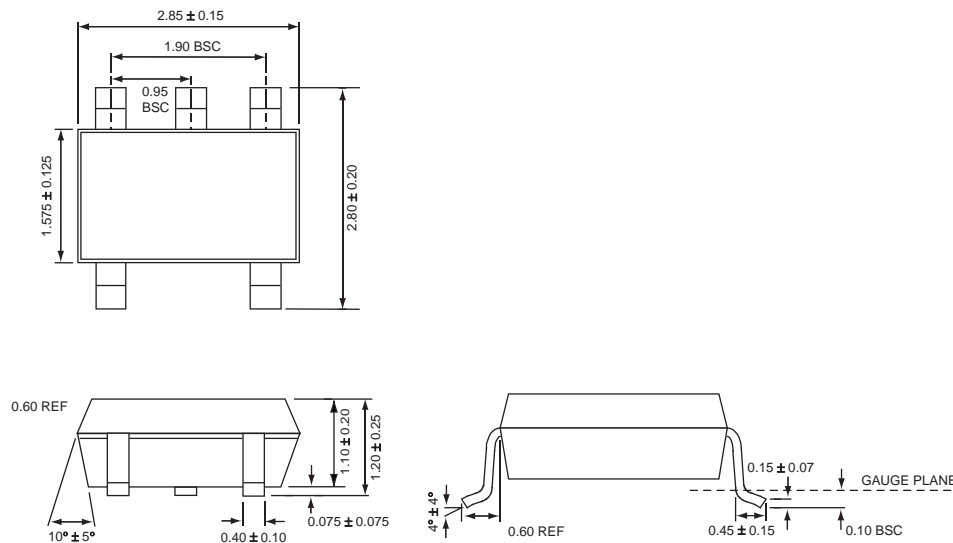

All dimensions in millimeters.

1. XYY = assembly and date code.
 2. Sample stock is generally held on part numbers listed in **BOLD**.

SC70JW-8

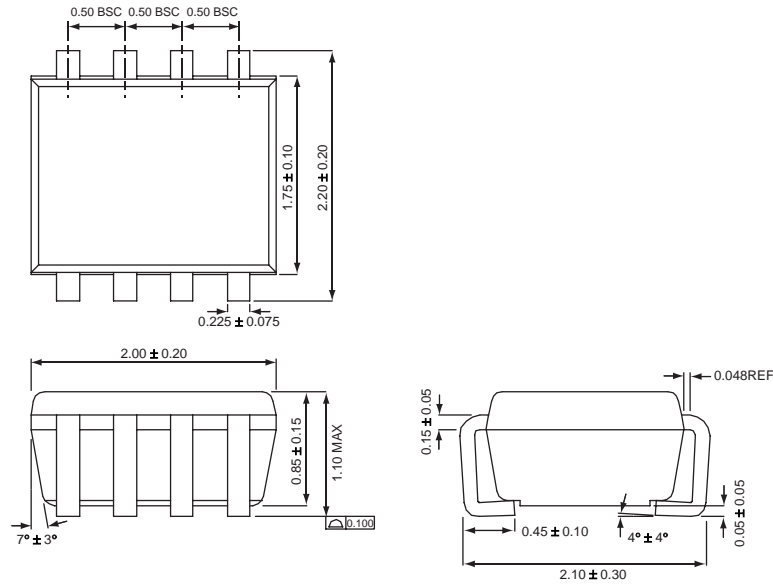

All dimensions in millimeters.

© Advanced Analogic Technologies, Inc.

AnalogicTech cannot assume responsibility for use of any circuitry other than circuitry entirely embodied in an AnalogicTech product. No circuit patent licenses, copyrights, mask work rights, or other intellectual property rights are implied. AnalogicTech reserves the right to make changes to their products or specifications or to discontinue any product or service without notice. Customers are advised to obtain the latest version of relevant information to verify, before placing orders, that information being relied on is current and complete. All products are sold subject to the terms and conditions of sale supplied at the time of order acknowledgement, including those pertaining to warranty, patent infringement, and limitation of liability. AnalogicTech warrants performance of its semiconductor products to the specifications applicable at the time of sale in accordance with AnalogicTech's standard warranty. Testing and other quality control techniques are utilized to the extent AnalogicTech deems necessary to support this warranty. Specific testing of all parameters of each device is not necessarily performed.

Advanced Analogic Technologies, Inc.
 830 E. Arques Avenue, Sunnyvale, CA 94085
 Phone (408) 737-4600
 Fax (408) 737-4611