

▼ 7717-133

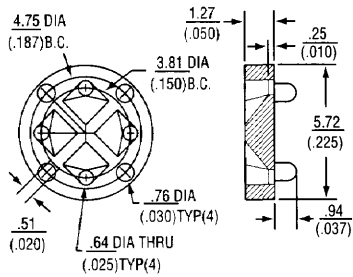

▼ 7717-137

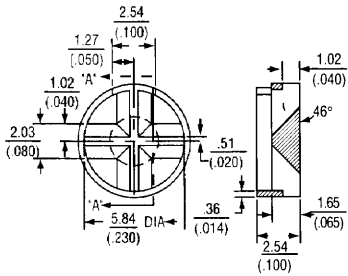

▼ 7717-139

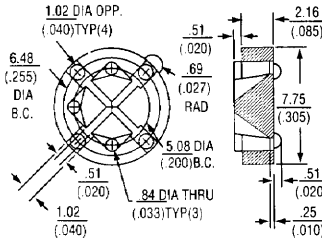

▼ 7717-149

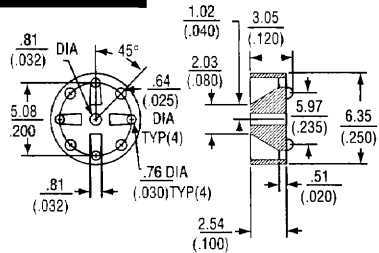

▼ 7717-247

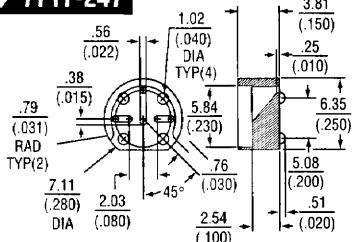

IC LEAD CONVERSION PADS

▼ 7717-19

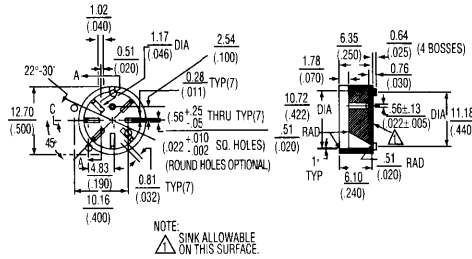

▼ 7717-21

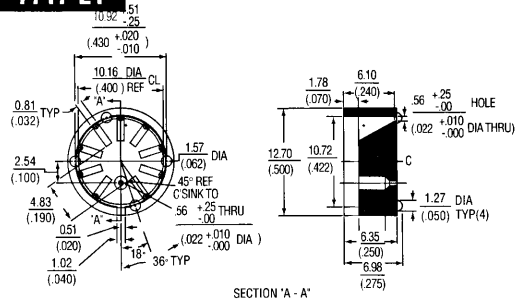

▼ 7717-107

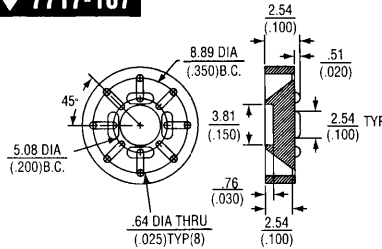

EPOXY LEAD CONVERSION PADS

▼ 7717-2

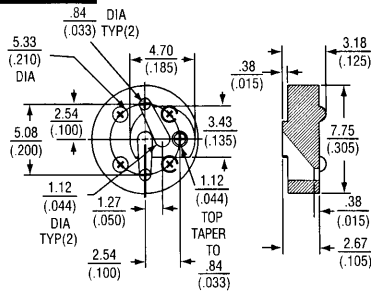

▼ 7717-130

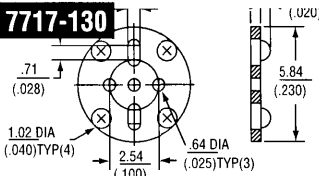

Note: Please specify material for each mounting pad: "N" for Nylon, "DAP" for Diallyl Phthalate, etc. For example: 7717-3N.